

GV60 MAX Electronic Ignition Remote Control for Valor heaters models LX2 2200 Series

LX2 2200 Remote Control Initial Set-up

The receiver and the handset of the remote control system must be initially synchronized before the first use. The receiver is located on the bottom of the fireplace behind the front panel under the valve heat shield. The battery holder is located next to the wall switch.

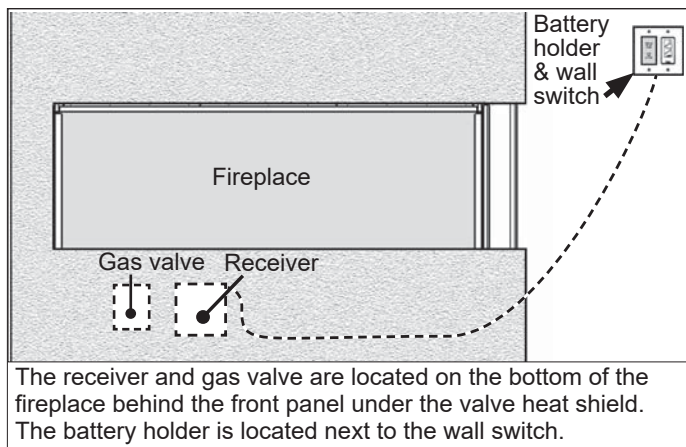

The receiver and gas valve are located on the bottom of the fireplace behind the front panel under the valve heat shield. The battery holder is located next to the wall switch.

1. Insert one 9 V **alkaline** battery in the handset.
2. Behind the front panel of the appliance, slide the valve heat shield to the right and locate the receiver. Detach it from the Velcro and pull it out.

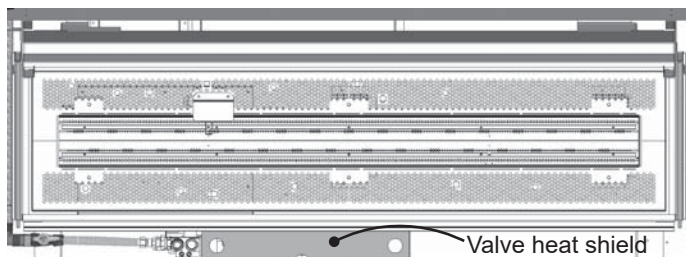

Top view—Valve heat shield closed

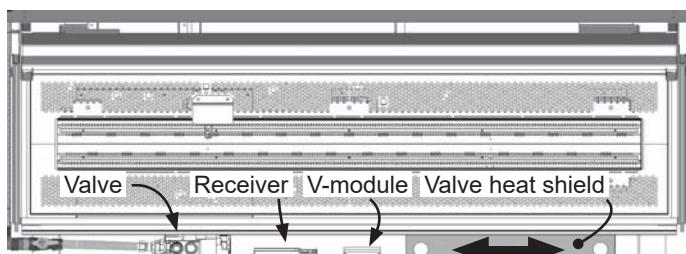

Top view—Slide valve heat shield opened

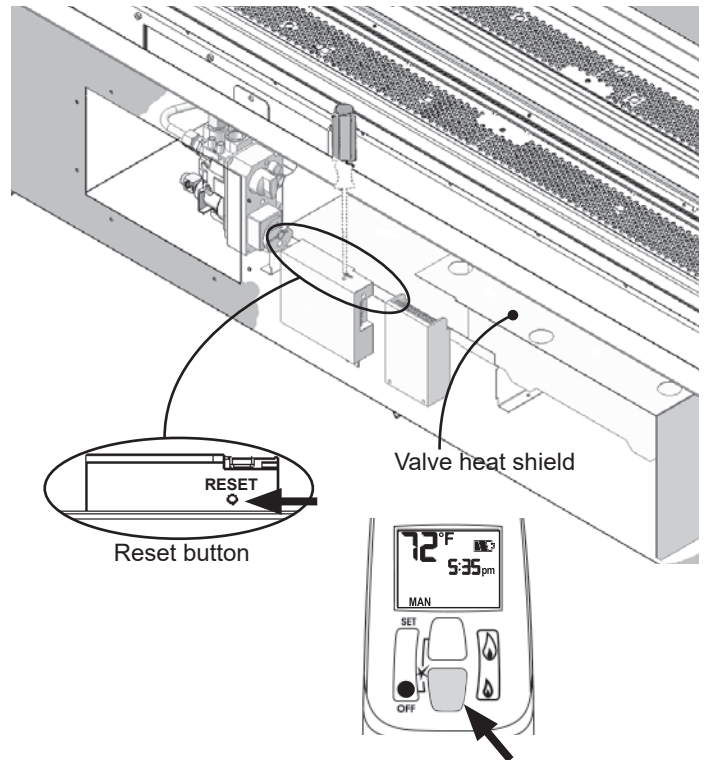

3. Locate the Reset button on the top side of the receiver.
4. With a sharp object, press and hold the receiver's reset button until you hear one short and one long beeps. Release the reset button after the second beep.
5. Within the subsequent 20 seconds, press the small flame button () on the remote handset until you hear two short beeps confirming the synchronization is set. This is a one time setting only and is not required when changing the batteries in the remote battery holder. The remote control system is now ready to use.
6. Put the valve heat shield back in place, over the valve, receiver and v-module.

WARNING

ALWAYS PUT THE VALVE HEAT SHIELD BACK IN PLACE over the valve, receiver and v-module! Otherwise, the controls can overheat and the fireplace stop working.

Remote Control Operation

Radio Frequency

315 MHz for USA and Canada.

This device complies with Part 15 of the FCC Rules and with Industry Canada license-exempt RSS standard(s). Operation is subject to the following two conditions:

- (1) this device may not cause harmful interference, and
- (2) this device must accept any interference received, including interference that may cause undesired operation.

NOTE: Before using the remote control system for the first time, the receiver and the handset must be synchronized. See the section *Remote Control Initial Set-up* on the previous page of this manual.

IMPORTANT: BEFORE YOU BEGIN, please note that on this system, the settings of time, temperature and automatic ON/OFF **can only be programmed when the function display is flashing**. Be patient when programming as it can take a few seconds to set.

Note: In the TEMP or TIMER modes, the remote handset senses the room temperature and adjusts the flame accordingly.

To communicate, the handset should be within 15 feet (4.5 meters) of the fireplace.

Do not leave the handset on the mantel or hearth.

TO TURN ON APPLIANCE

CAUTION

When pilot ignition is confirmed, motor turns automatically to maximum flame height.

On the valve, turn MAN knob on the ON, full counterclockwise  position.

Place ON/OFF switch (if equipped) in I (ON position).

Simultaneously press the OFF and  (large flame) buttons until a short beep confirms the start sequence has begun; release buttons.

Continuing beeps confirm the ignition is in process.

Once pilot ignition is confirmed, there is main gas flow.

After main burner ignition the handset will automatically go into manual (MAN) control mode.

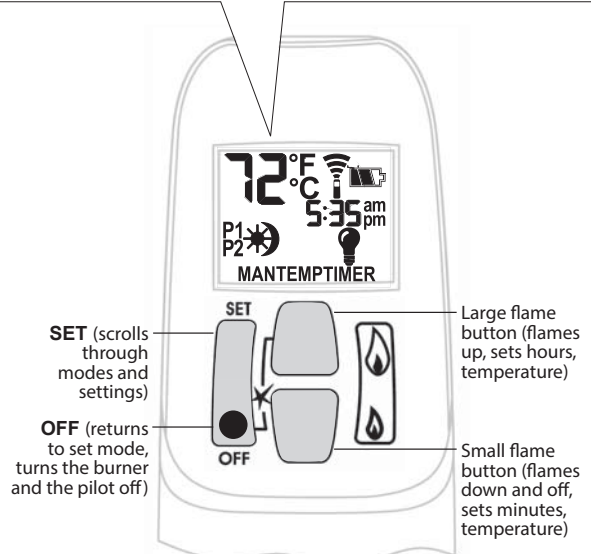
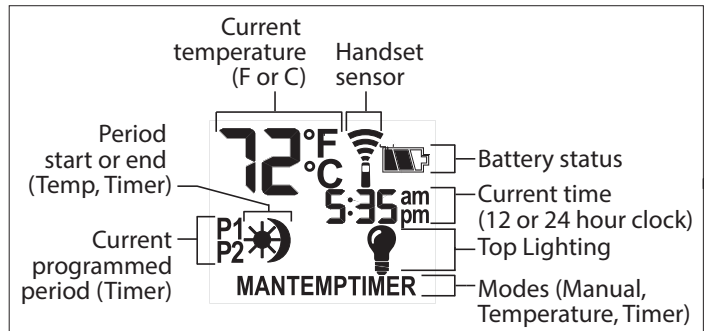
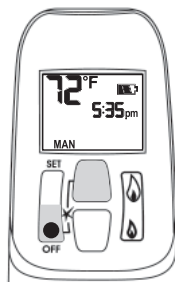

TO TURN OFF APPLIANCE

Press OFF button.

When the pilot is off, it will take 2 minutes before it can be lit again.

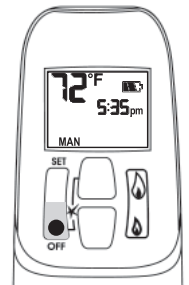





STANDBY MODE (Pilot Flame)

Press and hold  (small flame) to set appliance at pilot flame.

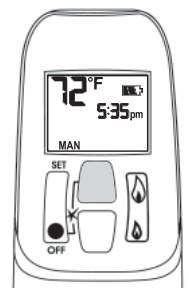
FLAME HEIGHT ADJUSTMENT

In standby mode: Press and hold  (large flame) button to increase flame height.



Press and hold  (small flame) button to decrease flame height or to set the appliance at pilot flame.
 For fine adjustment tap the  (large flame) or  (small flame) buttons.

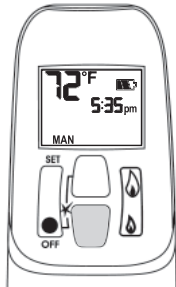

Express Low and High Fire

Double-click  (small flame) button. "LO" will be displayed.
 NOTE: Flame goes to high fire first before going to designated low fire.

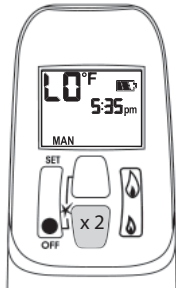

Double-click  (large flame) button. Flame automatically goes to high fire. "HI" will be displayed.

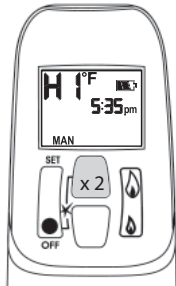

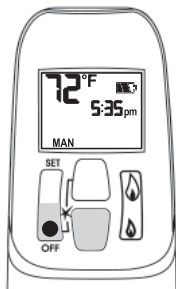

SETTING °C/24-HR OR °F/12-HR CLOCK

In MAN mode, press OFF and  (small flame) buttons until display changes from Fahrenheit/12-hour clock to Celsius/24-hour clock and vice versa.



SETTING THE TIME

The time display will flash after either:

- Installing the battery or
- Simultaneously pressing the  (large flame) and  (small flame) buttons.

Press  (large flame) button to set the hour.

Press  (small flame) button to set the minute.

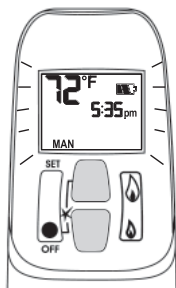

Press OFF or simply wait to return to MAN mode.

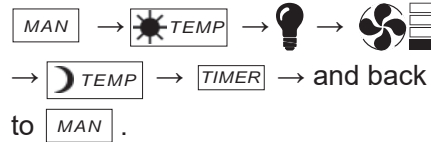

MODES OF OPERATION

Briefly pressing the SET button changes the mode of operation in the following order:



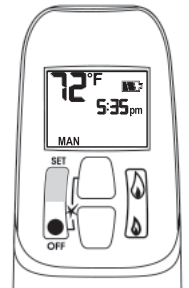

NOTE: Manual mode can also be reached by pressing either the  (large flame) or the  (small flame) buttons.

 - **Manual Mode** - Manual Flame Height Adjustment.

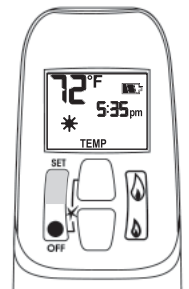

 - **Daytime Temperature Mode** (Appliance must be in standby mode; pilot ignited) - The room temperature is measured and compared to the set temperature. The flame height is then automatically adjusted to achieve the Daytime Set Temperature.



 - **Light/Dimmer Setting Mode** Turns light/dimmer ON and OFF and adjust brightness.

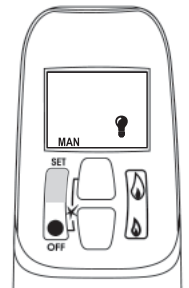

 - **Fan Mode** Not available on this fireplace.



- Nighttime Setback

Temperature Mode (Appliance must be in standby mode; pilot ignited) - The room temperature is measured and compared to the Nighttime Setback temperature. The flame height is then automatically adjusted to achieve the Nighttime Setback Temperature.

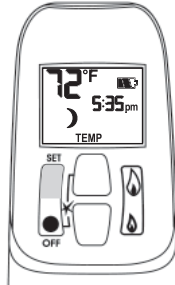

- Timer Mode

(Appliance must be in standby mode; pilot ignited) - The timers P1 and P2 (Program 1, Program 2) each can be programmed to go ON and OFF at specific times. For instructions see Timer Programming Mode.

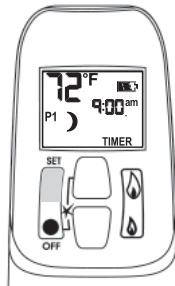



NOTE: The display shows the set temperature every 30 seconds.

LIGHT/DIMMER OPERATION (FIREBOX TOP)

- Light/Dimmer

Briefly press SET button to scroll to  (light bulb) mode. Light bulb icon flashes.

Press and hold  (large flame) button to turn ON the light or increase brightness.

Press and hold  (small flame) button to decrease brightness.

In the Light/Dimmer mode, the OFF button shuts off the light.

If you want the light ON but no flame, press and hold the  (small flame) button and turn to Pilot flame.



NOTE: The light bulb icon is displayed during light/dimmer setting only. 8 seconds after the light/dimmer has been set, the handset will automatically go into temperature control mode.

Tip

Set the different parameters when they are flashing.



SETTING THE ON / OFF TEMPERATURES

SETTING THE “DAYTIME” TEMPERATURE

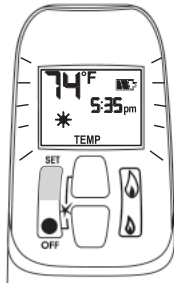

Default Settings:  TEMP (sun), 23°C / 74°F

Briefly press SET button to scroll to TEMP  TEMP (sun) mode. Hold the SET button until the TEMP flashes.

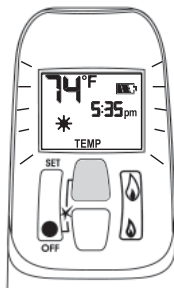

Press  (large flame) button to increase the  Daytime Set Temperature.



Press  (small flame) button to decrease  Daytime Set Temperature.

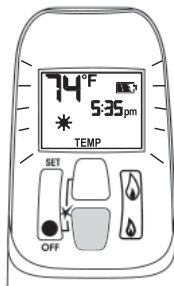

Press OFF or simply wait to complete programming.

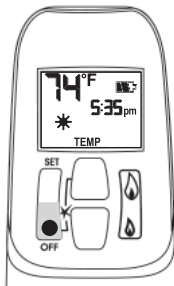



SETTING THE “NIGHTTIME SETBACK” TEMPERATURE

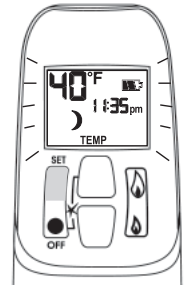

Default Settings:  TEMP (moon), “--” (OFF)

Briefly press SET button to scroll to TEMP  TEMP (moon) mode. Hold the SET button until the TEMP flashes.

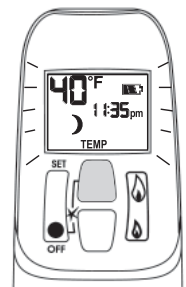

Press  (large flame) button to increase  Nighttime Setback Temperature.



Press  (small flame) button to decrease  Nighttime Setback Temperature.

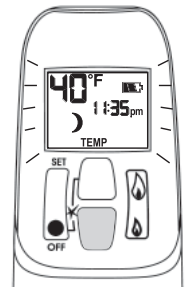

Press OFF or simply wait to complete programming.

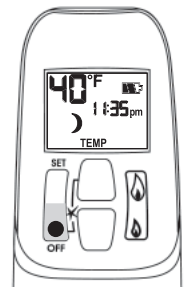

SETTING PROGRAM TIMERS

You can program two periods of time between 12:00 am and 11:50 pm in each 24-hour cycle.

The Programs P1 and P2 must be set in the following order during a 24-hour cycle: **P1** ☀, **P1** ☾, **P2** ☀ and **P2** ☾.

The icon ☀ indicates the beginning of the period (ON) and the icon ☾ indicates the end of the period (OFF).

If **P1** ☀ = **P1** ☾ or **P2** ☀ = **P2** ☾, the programming is cancelled.

To keep the fireplace ON all night, set **P2** ☾ at 11:50 am and **P1** ☀ at 12:00 am.

Default settings:

Program 1: **P1** ☀ 6:00 am **P1** ☾ 8:00 am

Program 2: **P2** ☀ 11:50 pm **P2** ☾ 11:50 pm

Briefly press SET button to scroll to TIMER mode.

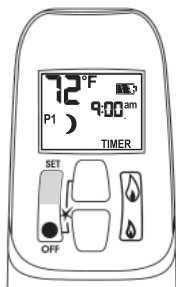

SETTING P1 ON TIME

Hold the SET button until **P1** ☀ (sun) is displayed and the time flashes.

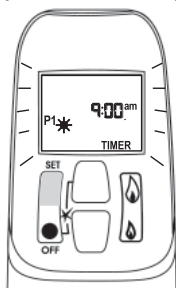

Press ☾ (large flame) button to set the hour.

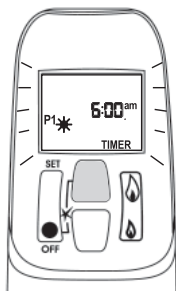

Press ☽ (small flame) button to set the minutes.

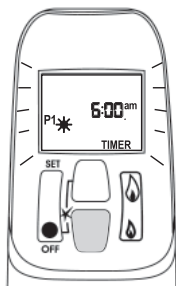

SETTING P1 OFF TIME

Briefly press SET button to scroll to TIMER **P1** ☾ (moon) while the time flashes.

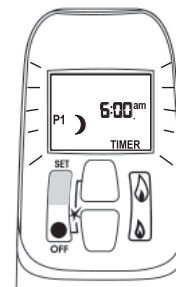

Press ☾ (large flame) button to set the hour.

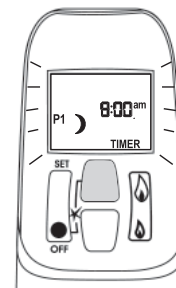

Press ☽ (small flame) button to set the minutes.

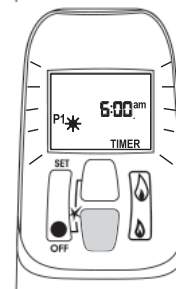

SETTING P2 ON TIME

Briefly press SET to scroll to TIMER mode **P2** ☀ (sun) while the time flashes.

Follow the instructions given to set P1 ON time.

SETTING P2 OFF TIME

Briefly press SET to scroll to TIMER mode **P2** ☾ (moon) while the time flashes.

Follow the instructions given to set P1 OFF time.

Press OFF button to save these settings. The timers are programmed. See the diagram on programming sequences on the following page.

Tip

If you want to program only one period, program **P1** ☀ and **P1** ☾ with desired times and program **P2** ☀ and **P2** ☾ with the same time as **P1** ☾.

Timer Programming Example (default temperatures shown)

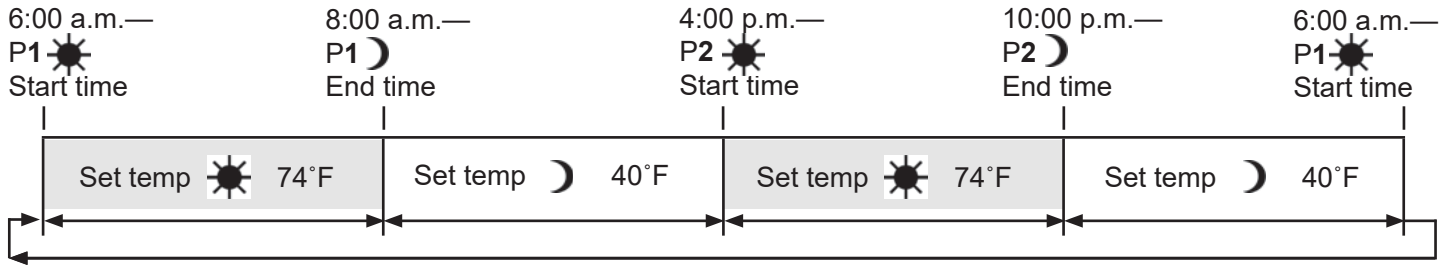

AUTOMATIC TURN DOWN

6 Hour no Motor Movement

Manual Mode/Temperature/Timer Mode: The valve will turn to pilot flame if there is no change in flame height for a 6 hour period. In Temperature/Timer Mode if the ambient room temperature changes, the flame height will adjust automatically to maintain set temperature, and the fire will continue to function normally. The valve will turn to pilot flame if the set temperature and the ambient room temperature remain the same over a 6 hour period.

AUTOMATIC SHUT OFF

Low batteries receiver. With low battery power in the receiver/battery holder the system shuts off the fire completely. This does not apply when the power supply is interrupted.

On-Demand Pilot. This green feature eliminates gas energy consumption during extended appliance inactivity. When the appliance is inactive for 5 days the system automatically extinguishes the pilot. This feature helps the consumer realize cost benefits by automatically eliminating energy consumption during non-heating months and limited use.

LOW BATTERY INDICATION

CAUTION

DO NOT USE a screwdriver or other metallic object to remove the batteries from the battery box or the handset! This could cause a short circuit.

Remote handset: The battery icon will show when the battery needs to be replaced. Replace with one 9 V **alkaline** battery.

Remote battery holder: Frequent 'beeps' for 3 seconds when the valve motor turns indicate the batteries need to be replaced. Replace with four 1.5 V **alkaline** batteries.

HANDSET / RECEIVER MATCH

The remote control handset and receiver are programmed to function together. In case of a replacement of the handset or the receiver, you will need to reset the receiver to allow them to function together. Contact your dealer for details.

Because our policy is one of constant development and improvement, details may vary slightly from those given in this publication.

Miles Industries Ltd.

190–2255 Dollarton Highway, North Vancouver, BC, CANADA V7H 3B1

Tel. 604-984-3496 Fax 604-984-0246

www.valorfireplaces.com