

# valor<sup>®</sup> Portrait



## Direct Vent Gas Insert Fireplace 530INI (natural gas) & 530IPI (propane gas)

### **DANGER**



**HOT GLASS WILL  
CAUSE BURNS.**

**DO NOT TOUCH GLASS  
UNTIL COOLED.**

**NEVER ALLOW CHILDREN  
TO TOUCH GLASS.**

A barrier designed to reduce the risk of burns from the hot viewing glass is provided with this appliance and must be installed for the protection of children and other at-risk individuals.

**Please read this manual  
BEFORE installing and  
operating this appliance.**

**INSTALLER:** Leave this manual with the appliance.  
**CONSUMER:** Retain this manual for future reference.

This manual contains instructions to install the **ENGINE ONLY**. A front trim is **REQUIRED** to complete the installation. A barrier screen is provided with the front kit. **Refer to the manual supplied with the front for installation.**

**⚠ WARNING**  
**FIRE OR EXPLOSION HAZARD**  
Failure to follow safety warnings exactly could result in serious injury, death, or property damage.

- Do not store or use gasoline or other flammable vapors and liquids in the vicinity of this or any other appliance.
- **WHAT TO DO IF YOU SMELL GAS**
  - Do not try to light any appliance.
  - Do not touch any electrical switch; do not use any phone in your building.
  - Leave the building immediately.
  - Immediately call your gas supplier from a neighbor's phone. Follow the gas supplier's instructions.
  - If you cannot reach your gas supplier, call the fire department.
- Installation and service must be performed by a qualified installer, service agency or the gas supplier.

This appliance may be installed in an after-market permanently located, manufactured (mobile) home where not prohibited by local codes.

This appliance is only for use with the type of gas indicated on the rating plate. This appliance is not convertible for use with other gases, unless a certified kit is used.

This appliance is a domestic room-heating appliance. It must not be used for any other purposes such as drying clothes, etc.

This appliance is suitable for installation in a bedroom or bed sitting room.

Installer: Place model/serial number here.

Ce guide est disponible en français sur demande.

# Table of Contents

## FOR THE OWNER

<b>Safety and Your Fireplace</b> .....	<b>3</b>
<b>Introduction</b> .....	<b>6</b>
Locating Fireplace & Lighting Information Card .....	6
Operating Your Fireplace for the First Time.....	6
<b>Operating Your Fireplace</b> .....	<b>7</b>
Fireplace Control Devices .....	7
How to Turn Your Fireplace OFF (including pilot).....	7
How to Ensure Your Fireplace Cannot Be Turned ON Inadvertently .....	7
<b>Using the Remote Control</b> .....	<b>8</b>
<b>Kits &amp; Accessories</b> .....	<b>12</b>
<b>Lighting Instructions</b> .....	<b>13</b>
<b>Servicing &amp; Maintenance</b> .....	<b>14</b>
Servicing Your Fireplace.....	14
Annual Inspection .....	14
Cleaning Your Fireplace .....	15
Checking Pilot and Burner Flames .....	17
Replacing Batteries .....	18
Using Handset Wall Holder.....	18
<b>Warranty—Indoor Installations</b> .....	<b>46</b>
<b>Warranty—Outdoor Installations</b> .....	<b>47</b>

## FOR THE QUALIFIED INSTALLER

<b>Specifications</b> .....	<b>19</b>
<b>Overview</b> .....	<b>20</b>
<b>Dimensions</b> .....	<b>23</b>
<b>Cavity</b> .....	<b>23</b>
<b>Clearances</b> .....	<b>24</b>
<b>Venting</b> .....	<b>25</b>
<b>Existing Fireplace Preparation</b> .....	<b>27</b>
<b>Installation Planning</b> .....	<b>27</b>
<b>Installation</b> .....	<b>28</b>
Remove Window .....	29
Co-Linear Applications (2 - 3" liners)—	
Connect Venting .....	30
Co-Axial Applications (3" x 5" liners using 590FVK2 and 530CVA2)—Connect Venting .....	31
Connect Gas Supply.....	32
Install Ceramic Liners (Logs or Coals only).....	33
Install the 530LSK—Traditional Logs Set.....	34
Install the 530CSK—Coal Set .....	35
Install the 530RSK—Rock Set and Liners.....	36
Install the 530DWK—Driftwood Kit and Liners .....	38
Refit and Check Window .....	40
Install Battery Holder .....	41
Synchronize Remote Control.....	41
Check Operation.....	42
Set Aeration .....	42
Install Front Trim and Barrier Screen.....	43
Install Remote Control Handset Wall Holder .....	43
<b>Wiring Diagram</b> .....	<b>44</b>
<b>Approved Venting Components</b> .....	<b>45</b>
<b>Warranty—Indoor Installations</b> .....	<b>46</b>
<b>Warranty—Outdoor Installations</b> .....	<b>47</b>
<b>Replacement Parts</b> .....	<b>48</b>

### Warranty Card at the back of this manual.

The information contained in this installation manual is believed to be correct at the time of printing. Miles Industries Ltd. reserves the right to change or modify any information or specifications without notice. Miles Industries Ltd. grants no warranty, implied or stated, for the installation or maintenance of your heater, and assumes no responsibility for any consequential damage(s).



We recommend that our gas hearth products be installed and serviced by professionals who are certified in the U.S. by the National Fireplace Institute® (NFI) as NFI Gas Specialists.

[www.nficertified.org](http://www.nficertified.org)

**Massachusetts:** The piping and final gas connection must be performed by a licensed plumber or gas fitter in the State of Massachusetts.

Designed and Manufactured by / for Miles Industries Ltd.  
 190 – 2255 Dollarton Highway, North Vancouver, B.C., CANADA V7H 3B1  
 Tel. 604-984-3496 Fax 604-984-0246  
[www.valorfireplaces.com](http://www.valorfireplaces.com)



## SAFETY AND YOUR FIREPLACE

**Read and understand** all instructions carefully before starting the installation. **Failure to follow** these installation instructions may result in possible fire hazard and will void the warranty.

**Prior to the first firing of the fireplace**, read the Owner's information section of this manual.

**Do not use this appliance if any part has been under water.** Immediately, call a qualified service technician to inspect the unit and to replace any part of the control system and any gas control that has been under water.

**This unit is not for use with solid fuel.**

**Installation and repair should be performed by a qualified service person.** The appliance and venting system should be **inspected** before initial use and at least annually by a professional service person. More frequent cleaning may be required due to excessive lint from carpeting, bedding, etc. It is **imperative** that the unit's control compartment, burner, and circulating air passageways **be kept clean** to provide for adequate combustion and ventilation air.

**Always keep the appliance clear and free from combustible materials**, gasoline, and other flammable vapors and liquids.

**Never obstruct the flow of combustion and ventilation air.** Keep the front of the appliance **clear** of all obstacles and materials for servicing and proper operation.

**This unit must be used with a vent system** as described in this installation manual. **No other vent system or components may be used.**

This gas fireplace and vent assembly must be vented directly to the outside and must never be attached to a chimney serving a separate solid fuel burning appliance. Each gas appliance must use a separate vent system. Common vent systems are prohibited.

**Inspect the external vent cap** on a regular basis to make sure that no debris, plants, trees, shrubs are interfering with the air flow.

**Turn off the gas before servicing** this appliance. It is recommended that a qualified service technician perform an appliance check-up at the beginning of each heating season.



### **WARNING:**

This product can potentially expose you to chemicals including Benzene which are known to the State of California to cause cancer and birth defects or other reproductive harm. **For more information go to [www.P65Warnings.ca.gov](http://www.P65Warnings.ca.gov)**

**Do not use this heater as a temporary source of heat during construction.**

Due to the high temperature, the appliance should be **located** out of traffic areas and away from furniture and draperies.

Clothing or flammable material **should not be placed** on or near the appliance.

This appliance is a **domestic room-heating appliance**. It must not be used for any other purposes such as drying clothes, etc.

**Do not** place furniture or any other combustible household objects within 36" of the fireplace front.

**Be careful not to put any decorating objects** sensitive to heat to close above or around the fireplace as it gets very hot when operating.

**The glass door assembly must be in place and sealed before the unit can be placed into safe operation.**

**Do not operate this appliance with the glass door removed, cracked, or broken.** Replacement of the glass door should be performed by a licensed or qualified service person. Do not strike or slam the glass door.

**The glass door assembly shall only be replaced as a complete unit**, as supplied by the fireplace manufacturer. No substitute material may be used.

Do not use abrasive cleaners on the glass door assembly. Do not attempt to clean the glass door when it is hot.

**A barrier designed to reduce the risk of burns** from the hot viewing glass is provided with this appliance and **shall be installed for the protection of children and other at-risk individuals.**

If the barrier becomes damaged, the barrier shall be replaced with the manufacturer's barrier for this appliance.

Any safety screen, guard or barrier removed for servicing the appliance, must be replaced prior to operating the appliance.

**Children and adults** should be alerted to the hazards of high surface temperature and should stay away to avoid burns or clothing ignition.

**Young children** should be carefully supervised when they are in the same room as the appliance. Toddlers, young children and others may be susceptible to accidental contact burns. A physical barrier is recommended if there are at-risk individuals in the house. To restrict access to a fireplace or stove, install an adjustable safety gate to keep toddlers, young children and other at-risk individuals out of the room and away from hot surfaces.



# Safety and Your Fireplace

## Read and carefully follow all safety warnings and operating instructions contained in your owner's manual

Replacement manuals are available by contacting the Valor Service Department at 1-800-468-2567 or visit [www.valorfireplaces.com](http://www.valorfireplaces.com).

### FOLLOW THESE IMPORTANT CHILD SAFETY PRECAUTIONS AND RECOMMENDATIONS

**Parts of your Valor Fireplace become extremely hot while in operation.**

**The glass viewing window temperature can exceed 500 F** at full capacity.

**Momentary contact with a hot glass surface can cause a severe burn**, even if the fireplace is operating at reduced heating capacity.

**The glass window will remain hot** for an extended period of time after the fireplace has been turned off. Ensure that children are prevented from touching the fireplace during the cool down period.

**Toddlers and Young Children must be closely supervised at all times** when they are in the same room as the operating fireplace. They lack full awareness of danger and rely on your protection. Toddlers, in particular, do not have the motor skills and response reflexes to withdraw in the event of accidental contact with a hot surface.

**A physical barrier is strongly recommended** if there are young children, or at-risk individuals in the house. Install an approved after-market safety gate to keep toddlers, young children and



other at-risk individuals a safe distance from the fireplace.

**Keep the remote control handset out of reach of children at all times.** A wall mount storage holster is provided with your remote control handset.

**Ensure that the fireplace, including the pilot light, is completely turned off** when children are present and close supervision and safety barriers are not available—see page 7 of this manual.

**If the fireplace is not going to be used** for the summer or any extended period of time, remove the batteries from the remote control handset and remote battery holder. It is recommended that batteries are replaced annually in any event—see page 18.



## SAFETY AND YOUR FIREPLACE

This manual and particularly the preceding and following pages contain very important information regarding the safe operation of your fireplace as well as maintenance instructions. Read carefully before operating your fireplace and pay special attention to the safety warnings.

A heating gas appliance does require safe handling. For this reason, we very strongly recommend children are not allowed to touch the fireplace or controls. **Install a screen or barrier in front of the fireplace to protect your children against severe burns.**

This appliance is designed and approved as a supplemental heater and provides the potential for most energy conservation when used while attended. The use of an alternate primary heat source is advisable.



## WARNING EXTREMELY HOT!!!

- **Read the safety information starting on page 3 of this manual before operating your gas heater.**
- Some parts of your fireplace are **extremely hot**, particularly the **glass** window.
- **Do not let children touch the glass** or any parts of your fireplace **even after it is turned off** as it is still hot.
- **Use the barrier screen** provided with the trim or a gate to reduce the risk of severe burns.
- Keep the remote control handset **out of reach of children.**
- **Hot hearth/floor surface!** The hearth or floor directly in front of the fireplace is very hot when the fireplace heats. Even if constructed of non-combustible materials, and although safe, it may reach temperatures **in excess of 200° F** depending on choice of materials. **Do not step on it!**
- Some materials or items, although safe, may discolor, shrink, warp, crack, peel, and so on because of the heat produced by the fireplace. **Avoid placing** candles, paintings, photos, and other items **sensitive to heat** within 36 inches (0.9 m) around the fireplace.
- Solid wood flooring in front of the fireplace (if allowed) may shrink during the heating season due to heat.

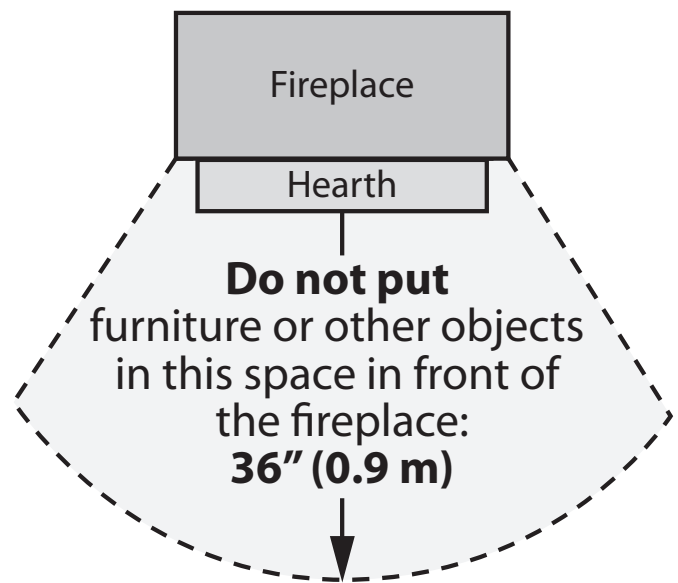



# Operating Your Fireplace

## Fireplace Control Devices

There are three ways to control your fireplace.

1. Thermostatic Remote Control;
2. Manual On/Off Switch;
3. Wall Switch (optional) .

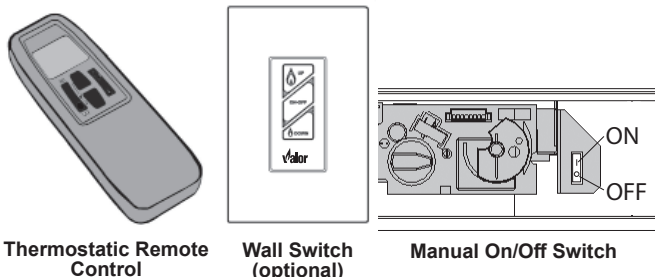

The Thermostatic Remote Control can be programmed to function automatically—see page 8.

The manual On/Off switch must be ON for the fireplace to function. It can be used to shut off the fireplace in case of emergency—see below.

The Wall Switch (optional) can be used to turn on, off and to increase or decrease the flame height—see 1265WSK or RBWSK—Wall Switch Kit.

**NOTE:** The remote control in the AUTO mode will override the wall switch.

### How to Turn Your Fireplace OFF (including pilot)

Familiarize yourself with each of these methods before operating your fireplace.

**Handset and Wall Switch:** Press and hold the OFF button for a second (either on the handset or the wall switch).

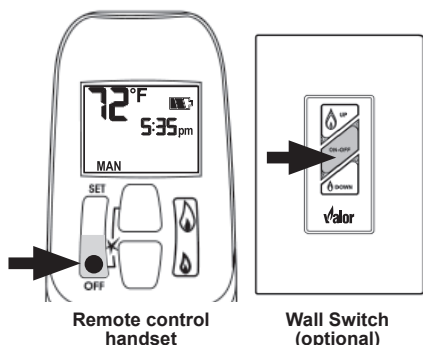

If the flames are on, they go down and you hear the valve motor wind down. You hear a clunk and a beep indicating that the valve has received the signal from the remote control.

In the unlikely event that you cannot turn off your fireplace with the remote control handset, use the wall switch (if installed); if the wall switch malfunctions and will not turn off the fireplace, wait 6 hours and the fireplace will automatically go to pilot. You can then access the controls inside your fireplace. Alternately, turn off gas supply. In all cases, call your dealer for service assistance.

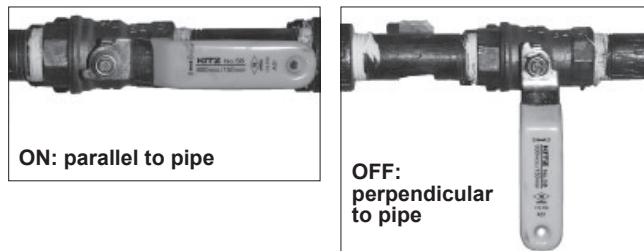

### How to Ensure Your Fireplace Cannot Be Turned ON Inadvertently

You can use one of the two following methods to ensure that your fireplace will not turn on when you don't want it on.

**⚠ WARNING**

**RISKS OF SEVERE BURNS! SURFACES OF THE FIREPLACE ARE VERY HOT DURING OPERATION!** Be very careful and wear gloves to access controls.

- You can prevent your fireplace from lighting by pressing the **O** button on the manual ON/OFF switch on the gas valve.

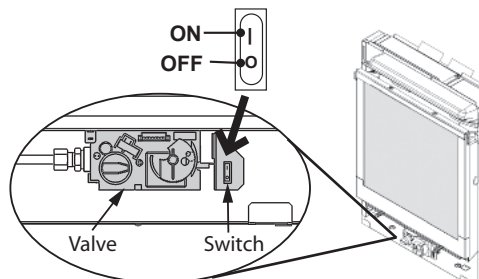

- Alternately, you can remove all batteries from the battery holder as well as the battery from the handset.

### Automatic Shut-Off (in certain conditions)

Your fireplace's remote control is equipped with an automatic shut-off mechanism which is activated in certain conditions. See page 11 in the *Using the Remote Control* section for a description of this feature.

## Using the Remote Control

### Radio Frequency

315 MHz for USA and Canada.

This device complies with Part 15 of the FCC Rules and with Industry Canada license-exempt RSS standard(s). Operation is subject to the following two conditions:

- (1) this device may not cause harmful interference, and
- (2) this device must accept any interference received, including interference that may cause undesired operation.

**NOTE: Before using the remote control system for the first time,** the receiver and the handset must be synchronized. See the section *Synchronize Remote Control* on page 1.

**IMPORTANT: BEFORE YOU BEGIN,** please note that on this system, the settings of time, temperature and automatic ON/OFF **can only be programmed when the function display is flashing.** Be patient when programming as it can take a few seconds to set.

Note: In the TEMP or TIMER modes, the remote handset senses the room temperature and adjusts the flame accordingly.

To communicate, the handset should be within 15 feet (4.5 meters) of the fireplace.

**Do not leave the handset on the mantel or hearth.**

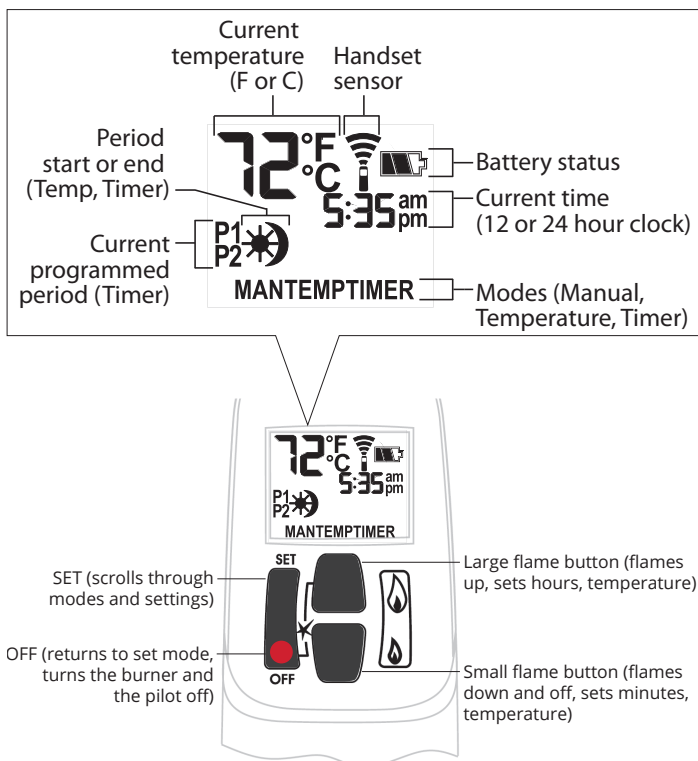

### Turn Fireplace ON

Press ● + 🔥 buttons until you hear a short beep; release buttons.

Beeping continues until pilot is lit.

Burner lights to maximum flame height and handset goes automatically to manual (MAN) mode.

NOTES:

On the valve, MAN button must be at ON, in full counter-clockwise position ↺.

ON/OFF switch (if equipped) must be in I (ON) position.

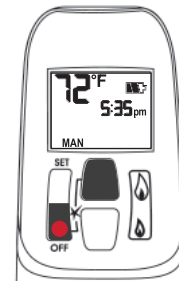

### Turn Fireplace OFF

Press ● button.

When pilot is just turned off, wait 2 minutes to light it again.

### Standby Mode (Pilot Flame)

Press and hold 🔥 to set fireplace to pilot.

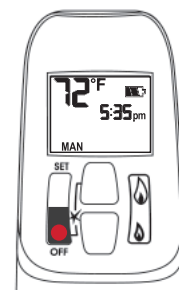

### Adjust Flames Height

With pilot lit, press and hold buttons:

- 🔥 = increase flame height
- 🔥 = decrease flame height or set to pilot

For fine adjustment, tap buttons.

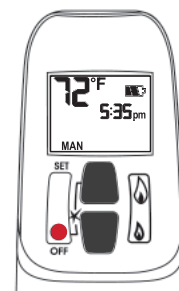

### Express Low and High Fire

Double-click buttons:

- 🔥 = increase flame to maximum height "HI"
- 🔥 = decrease flame minimum height "LO"

NOTE: Flame goes to high fire first before going to designated low fire.

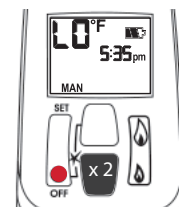
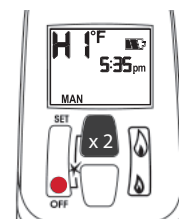



# Using the Remote Control

## Setting °C/24-hr or °F/12-hr clock

In MAN mode, press and hold ● + 🔥 buttons until temperature / clock display changes from

°F / 12-hour ↔ °C / 24-hour

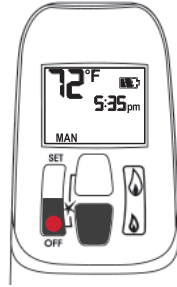

## Setting Time

The time display will flash after either:

- installing the battery, or
- pressing 🔥 + 🔥

To set the time, press buttons:

🔥 = hour

🔥 = minutes

Press ● or wait to go back to MAN.

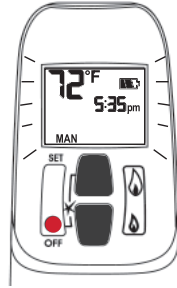

## Modes of Operation

Briefly pressing SET cycles through modes of operation.



NOTE: Press 🔥 or 🔥 to reach MAN mode.

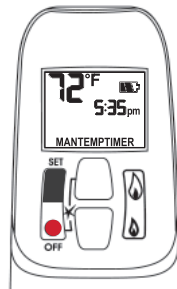

## MAN Manual Mode

Manual flame height adjustment.



## ⚡TEMP Daytime Temperature Mode

When pilot is lit, room temperature is measured and compared to set temperature. Flame height automatically adjusts to reach Daytime Set Temperature.



## 🌙TEMP Night time Setback Temperature Mode

When pilot is lit, room temperature is measured and compared to set temperature. Flame height automatically adjusts to reach Night Time Setback Temperature.

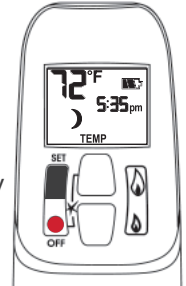

## TIMER Timer Mode

When pilot is lit, two periods of time (P1 and P2) can be programmed to use Daytime and Night time temperatures at specific times.

Note: Display shows set temperature every 30 seconds.

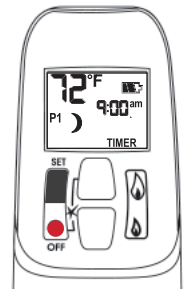

Set the different parameters when they are flashing.

## Using the Remote Control

### Setting high / low Temperatures

#### Setting "DAYTIME" high temperature.

Default Settings:  TEMP 23 °C/74 °F

Press SET to scroll to  TEMP

Hold SET button until TEMP flashes.

To set  Daytime Temperature:

 = increases temperature.

 = decreases temperature.

Press  or wait to complete setting.

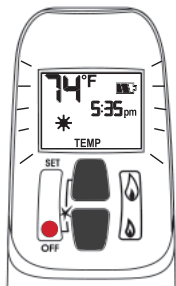

#### Setting "NIGHT TIME SETBACK" low temperature.

Default Settings:  TEMP "--" (OFF)

Press SET to scroll to  TEMP

Hold SET button until TEMP flashes.

To set  Night Time Temperature:

 = increases temperature.



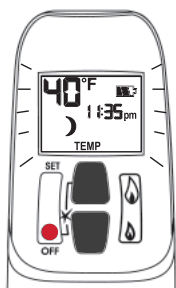

 = decreases temperature.

Press  or wait to complete setting.



### Setting Program Timers



You can program two periods of time between 12 am and 11:50 pm in each 24-hour cycle.



Programs P1 and P2 must be set in the following order during a 24-hour cycle: **P1** , **P1** , **P2**  and **P2** .

 = Day Time temperature (high) program period

 = Night Time temperature (low) program period





#### Default Settings:



Program 1: **P1**  06:00 am **P1**  08:00 am





Program 2: **P2**  11:50 pm **P2**  11:50 pm

Press SET to scroll to **TIMER**.



If **P1**  = **P1**  or **P2**  = **P2** , programming is cancelled.

To keep fireplace ON all night, set **P2**  at 11:50 am and **P1**  at 12:00 am.

If you want to program only one period, program **P1**  and **P1**  with desired times then **P2**  and **P2**  with the same time as **P1** .

#### Setting P1 time—high temperature.

Hold SET button until **P1**  is displayed and time flashes.

To set time:

 = hour

 = minutes

Press  or wait to complete setting.

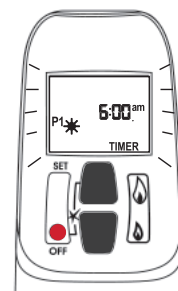

#### Setting P1 time—low temperature.

Hold SET button until **P1**  is displayed and time flashes.

To set time:

 = hour

 = minutes

Press  or wait to complete setting.

## Using the Remote Control

### Setting P2 high and low temperature times.

Repeat same steps as Setting P1.

When all settings are complete, press ● to save them.

### Timer Programming Example (default temperatures shown)

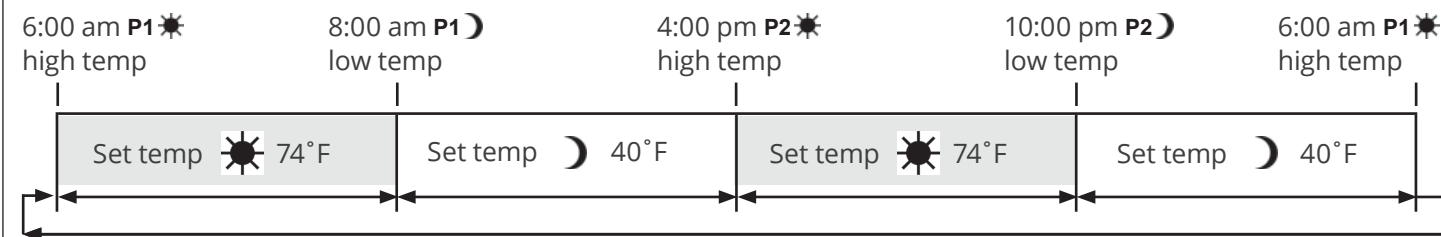

### Automatic Turn Down

#### 8-Hour no Motor Movement

The valve will turn to pilot flame if there is no motor movement for an 8-hour period.

### Automatic Shut-Off

**Low Batteries Receiver.** With low battery power in the battery holder the system shuts off the fire completely. This does not apply when the power supply is interrupted.

**On-Demand Pilot (7 Day Shut-Off).** This green feature eliminates gas energy consumption during extended appliance inactivity. When the appliance is inactive for an extended period of time the system automatically extinguishes the pilot. This feature helps the consumer realize cost benefits by automatically eliminating energy consumption during non-heating months and limited use.

The programmed length of inactivity to activate the system is specified by the appliance manufacturer and cannot be altered in the field.

### Low Battery Indication

#### Caution

DO NOT USE a screwdriver or other metallic object to remove batteries from holder. This could cause a short-circuit.

**Handset:** The battery icon  will show when the battery needs to be replaced. Replace with one 9 V **alkaline** battery.

**Battery holder:** Frequent 'beeps' for 3 seconds when the valve motor turns indicate the batteries need to be replaced in battery holder. Replace with four 1.5 V **alkaline** batteries.

### Handset / Receiver Match

The remote control handset and receiver are programmed to function together. In case of a replacement of the handset or the receiver, you will need to reset the receiver to allow them to function together. Contact your dealer for details.

## Kits & Accessories

### Required Kits

Information accurate at the time of printing and subject to change without notice.

<b>Fuel Beds (choose one)</b>	
530LSK	Traditional Logs & Reversible Liners Set
530RSK	Rocks & Reversible Liners Set
530CSK	Coals & Reversible Liners Set
530DWK	Driftwood & Reversible Liners Set

<b>Fronts (choose one)</b>	<b>Barrier Screen Number</b>	
536CXBI	President Insert Front (closure plate 582 or 583 required)	4006382
539/549/550	Arches Windsor and Classique (as inserts only)	4003290
541BPC	Bolero Front (as insert only) (closure plate 582 or 583 required)	4003289
545CFV	Clearview Insert Front (closure plate 582 optional)	4005146
546	Ledgeview Insert Fronts	4005099
563CSB	Senator Front (as insert only) (closure plate 582 or 583 required)	4003291

### Optional Accessories

Information accurate at the time of printing and subject to change without notice.

<b>Gas Conversion Kits</b>	
530NGK	Conversion kit to natural gas
530PGK	Conversion kit to propane gas

<b>Other Accessories</b>	
555CFK	Circulating Fan Kit
567FGP	Top Grille (with logs, driftwood and rocks ONLY)
580RGL	Reflective Glass Liners (Installs on top of liners supplied with fuel beds)
582CPB	Closure Plate black 26" w x 31" h (use with 536CXBI, 541BPC, 563CSB or 545CFV)
583CPB	Closure Plate black 30" w x 33" h (use with 536CXBI, 541BPC or 563CSB)
530CVA2	Co-Axial Appliance Adapter - converts from 2 x 3" co-linear to 5 x 3" co-axial flex using 590FVK2 Flex Vent Kit and Terminal Adapter/Flashing
RBWSK	Remote Battery and Wall Switch Kit
1265WSK	Wall Switch Kit
GV60PAK	AC Adapter
GV60CKO	Outdoor Conversion Kit
<b>Hearth Gate</b>	Hearth gates such as Cardinal's VersaGates are available at retail stores carrying safety products for children.

### **WARNING**

**Optional electrical accessories ARE NOT ALLOWED when adapting appliance for outdoor use.**

# Lighting Instructions

## FOR YOUR SAFETY, READ BEFORE LIGHTING

**WARNING:** If you do not follow these instructions exactly, a fire or explosion may result causing property damage, personal injury or loss of life.

- A. This appliance has a pilot which must be lighted by hand or by remote control. Follow these instructions exactly. To save gas, turn the pilot off when not using the appliance for a prolonged period of time.
- B. BEFORE LIGHTING, smell all around the appliance area for gas. Be sure to smell next to the floor because some gas are heavier than air and will settle on the floor.

### WHAT TO DO IF YOU SMELL GAS

- Do not try to light any appliance.
  - Do not touch any electric switch; do not use any phone in your building.
  - Immediately call your gas supplier from a neighbor's phone. Follow the gas supplier's instructions.
  - If you cannot reach your gas supplier, call the fire department.
- C. Use only your hand to push in or turn the control knobs. Never use tools. If the knobs will not push in or turn by hand, don't try to repair them; call a qualified service technician. Force or attempted repair may result in a fire or explosion.
  - D. Do not use this appliance if any part has been under water. Immediately call a qualified service technician to inspect the appliance and to replace any part of the control system and any gas control, which has been under water.

## LIGHTING INSTRUCTIONS

1. STOP! Read the safety information above. Dependent on model, switch #1 may be mounted directly to valve see Fig 2A.

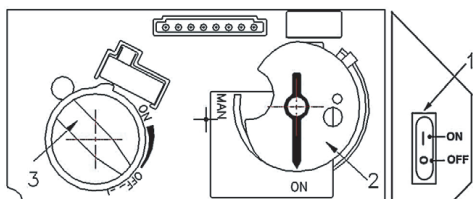

Fig 1

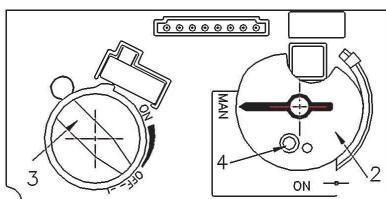

Fig 2

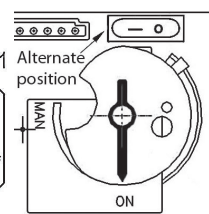



Fig 2A

2. SET ON/OFF SWITCH (1) TO "OFF" POSITION.

- Wait five (5) minutes to clear out any gas, then smell for gas, including near the floor. If you smell gas, STOP! Follow "B" in the safety information above on this label. If you don't smell gas, go to the next step.

3. AUTOMATIC IGNITION (fig. 1): Locate the pilot (fig 3.) inside of firebox at Left Hand side.

- ON/OFF switch (1) in ON position, MAN-knob (2) in ON position; set Flame Adjustment knob (3) to lowest setting (∩);
- On the remote control handset, press and hold the 'off' button and  (large flame) simultaneously; a short acoustic signal confirms the start has begun;
- Further short acoustic signals indicate the ignition process is in progress;
- When the pilot is lit, the Flame Adjustment knob (3) will automatically rotate to the highest setting.
- Press the  (small flame) on the remote control handset to reduce the flame height.

4. MANUAL IGNITION (fig. 2): With the window off, locate the pilot (fig. 3)

- inside of firebox at Left Hand side;
- ON/OFF switch (1) in ON position, MAN-knob (2) in MAN position;
- Set Flame Adjustment knob (3) to the lowest setting (∩);
- Push down the metallic core (4) with a pen or similar instrument; this will establish the pilot gas flow;
- Light gas at the pilot (5) with a match;
- Continue holding down metal core (4) for about 10 seconds; after release, pilot should remain lit;
- If the pilot will not stay lit after several tries, turn the gas control knob (3) to "OFF" (∩) and call your local service technician or gas supplier.

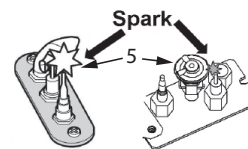



Fig 3

Reinstall the window and set the MAN-knob (2) to "ON"; turn Flame Adjustment knob (3) up (∩) or down manually or use the up/down 'flame' buttons on the remote control handset to adjust the flame height.

## TO TURN OFF GAS TO APPLIANCE

1. AUTOMATIC SHUT-OFF (using the remote control handset):

- Press and hold the  (small flame) on the remote control handset to shut-off the main burner gas flow;
- Press "OFF" button on remote handset to shut-off the appliance, including pilot flame.

2. MANUAL SHUT-OFF (using only the ON/OFF switch (1))

- Press "O" the ON/OFF switch (1) to shut-off the appliance.

### Servicing Your Fireplace

We recommend having your fireplace serviced every year. Contact your supplier quoting the model number. It will be helpful if the appliance's serial number can also be quoted. These numbers are on the information card. The replacement parts are shown at the end of this manual. Please always quote the part number and description when requesting spare parts.

#### Annual Inspection

In order to maintain the safe operation of your fireplace, contact your dealer to have a qualified technician go over the list below and make the necessary verifications at least once every year.

### Safe Operation List

To be performed by a qualified technician only

1. Inspect and operate the pressure relief mechanism to verify relief mechanisms are free from obstruction to operate. See *Cleaning Your Fireplace: To refit the window* section of this manual.
2. Clean glass window with a suitable fireplace glass cleaner. Abrasive cleaners must not be used. Be careful not to scratch the glass when cleaning. See *Cleaning Your Fireplace* section of this manual.
3. Inspect the operation of the flame safety system Pilot or Flame rectification device.
4. Inspect and ensure the lighting of the main burner occurs within 4 seconds of the main gas valve opening. Visual inspection should match that outlined in the appliance instruction manual. Inspect primary air openings for blockage. See *Checking Pilot and Burner Flame* section of this manual.
5. Inspect condition of vent and vent terminal for sooting or obstruction and correct if present.
6. Vacuum and clean any debris in the firebox that is not supposed to be there.
7. Test and measure the flame failure response time of the flame safety system. It must de-energize the safety shutoff in no more than 30 seconds.
8. Check all accessible gas-carrying tubes, connections, pipes and other components for leaks. See *Set up Gas Supply* section of this manual.

### Cleaning Your Fireplace

#### **⚠ WARNING**

**DO NOT TOUCH THE GLASS WHILE IT IS HOT!**  
Let the fireplace cool first before cleaning it.

#### **Important - Glass cleaning - Mineral deposits**

One of the by-products of the combustion process in a gas appliance is a mineral which can show up as a white film on the ceramic glass of the viewing door.

The composition of the deposit varies with location and time. It is believed to be associated with the varying sulfur content of the gas. You may have the problem intermittently.

We have consulted with ceramic glass manufacturers and they cannot offer a definitive solution to this problem. Dealers have tried various cleaning products with varying results. The following are recommendations only and are not meant to guarantee results.

**NOTE: This is a problem beyond Miles Industries' control and is not covered under warranty.**

- Clean the glass regularly as soon as you notice the buildup (white film). If the film is left for a longer period of time, it will etch into the glass. It is then much harder, if not impossible, to remove.
- **NEVER use an abrasive cleaner or ammonia-based cleaner on the ceramic glass.** Any abrasion of the surface has the immediate effect of compromising the strength of the glass. An emulsion type cleaner is recommended.
- Use a soft damp cloth to apply the cleaner. Dry the glass with a soft, dry, preferably cotton cloth. Most paper towels and synthetic materials are abrasive to ceramic glass and should be avoided.
- Our dealers have had good results from the products listed below. We cannot, however, guarantee the results of these products.
  - Brasso, Polish Plus by Kelkem, Cook Top Clean Creme by Elco, White Off by Rutland, Turtle Wax

#### **Do not clean the glass while it is hot!**

Always securely replace the window and the barrier screen before lighting.

**If broken, the glass pane may only be replaced as a complete window unit as supplied by the manufacturer.**

**If the barrier becomes damaged, the barrier shall be replaced with the manufacturer's barrier for this appliance.**

Clean the window panes following the guidelines in this section.

Clean the steel trim with mild soap and warm water. Any alcohol/solvent base cleaner will weaken the coating and damage it.

Clean the barrier screen dusting it with a soft brush.

Clean the firebox ceramic logs/rocks and walls dusting them with a soft brush. Dust can also be removed from the burner using a soft brush after removing the fuel bed. **When cleaning, make sure that no particles are brushed into the slots of the burner.**

#### **To remove the window for cleaning:**

1. Unhook the front and barrier screen.
2. Release the top of the window by pulling forward and unhooking the two clamping bars at the top corners.
3. Unscrew the two spring-loaded bolts securing the bottom of the window.

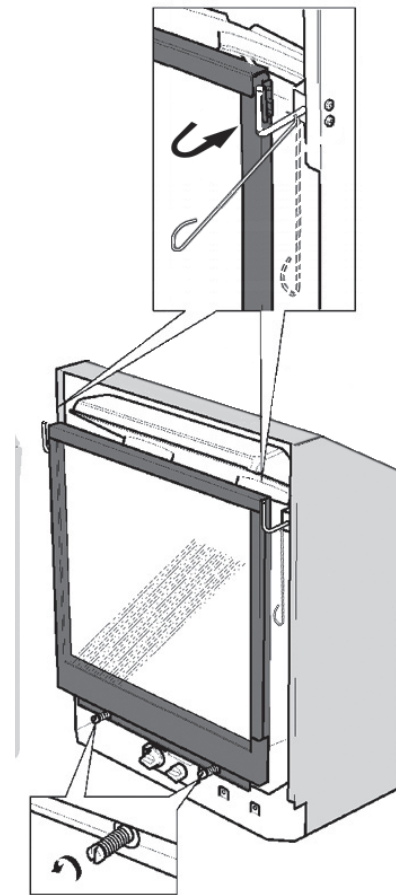

4. Carefully lift the window. Keep the window and bolts in a safe place.

## Servicing & Maintenance

To refit the window:

### **! DANGER**

The window unit must be correctly installed, fastened and sealed after servicing or serious bodily injury and/or damage to the appliance may result.

To ensure a safe operation:

- Double-check that the bottom of the window frame is correctly bolted at the bottom;
- Verify that the levers are hooked properly to the window tabs then;
- Pull out the top and bottom of the window and release it to insure the springs return it;
- Ensure the window is sealed before operation.

### **! WARNING**

Failure to install the window correctly can:

- Leak carbon monoxide.
- Affect the performance of the fireplace.
- Damage components.
- Cause overheating resulting in dangerous conditions.

Damage caused by incorrect window installation is not covered by the Valor warranty.

1. Place the window centrally against the engine unit resting it on the support at bottom front of the engine.
2. Pull the clamping bars forward and hook them to the window frame bracket to secure the top of the window.
3. Fit the two spring loaded bolts through the bottom of the window and tighten to secure the bottom of the window.

4. Pull the top of the window forward and release to ensure the springs return it in position.
5. Similarly check the bottom of the window by pulling it forward and releasing.

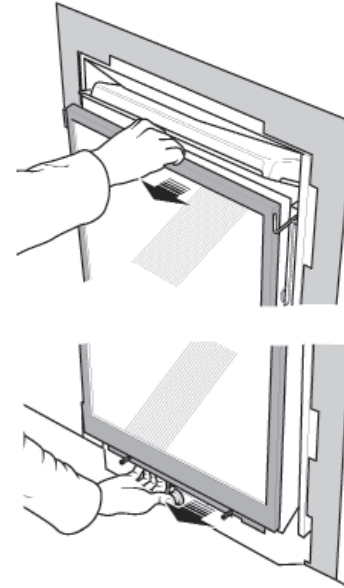

6. Apply firm hand pressure around the window frame to ensure the window is sealed tight against the firebox.
7. If the Hot Glass Warning plate has been removed from the front lower corner of the window, reinstall it by sliding it between the glass and the frame as indicated.



8. Reinstall the front and barrier screen.

### **! WARNING**

**FOR SAFETY PURPOSE**, ensure the barrier screen is re-installed on the fireplace front after maintenance.



## Servicing & Maintenance

### Checking Pilot and Burner Flames

A periodic check of the pilot and burner flames should be made. Check after the fire has been on for at least 30 minutes. The pilot flame must cover the tip of the thermocouple probe. The main burner flame pattern will vary from appliance to appliance depending on the type of installation and climatic conditions.

The appliance area must always be kept clear and free from combustible materials, gasoline and other flammable vapors and liquids. Inspect the vent terminal outdoors regularly to make sure that dirt, snow, insects, leaves, shrubs, trees do not obstruct it. Examine the whole vent system regularly. We recommend annually.

#### Correct flame appearance



530LSK—Traditional Logs

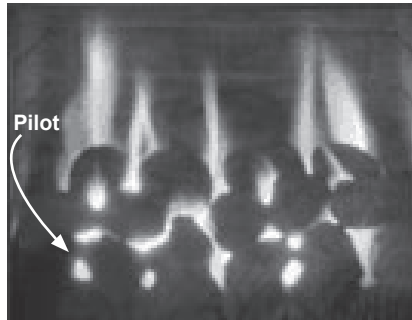

530CSK—Coals

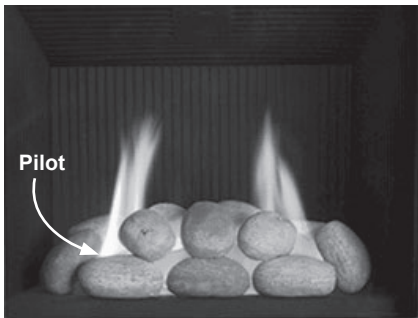

530RSK—Rocks



530DWK—Driftwood

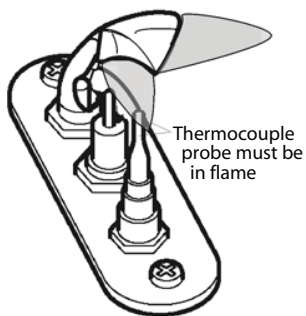

**Replacing Batteries**

**⚠ WARNING**

**DO NOT ATTEMPT TO CHANGE THE BATTERIES WHILE THE FIREPLACE IS STILL HOT!** Let the fireplace cool first before touching it.

**CAUTION**

**DO NOT USE** a screwdriver or other metallic object to remove the batteries from the battery holder or the handset! This could cause a short circuit to the receiver.

**Low battery signal: see page 11.**

**BEFORE** changing the batteries, **turn off the valve using the manual On/Off switch**—see instructions on page 7.

The appliance uses four 1.5 V AA **alkaline** batteries for its remote control receiver battery holder and one 9 V **alkaline** battery for its handset. The batteries should last one to two seasons, depending on usage. Removing the batteries in the off-season will extend the battery life. Should the batteries lose power, the control may be operated by manually turning the control knob at the valve or by turning off the valve at the switch.

**To replace the batteries in the battery holder**

1. The battery holder is located below the firebox on the right hand side. Remove the front trim. Grab the battery holder and pull it out from its location.

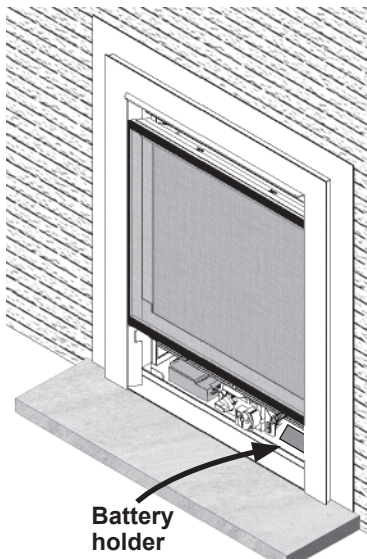

2. Disconnect the battery holder from the cable.

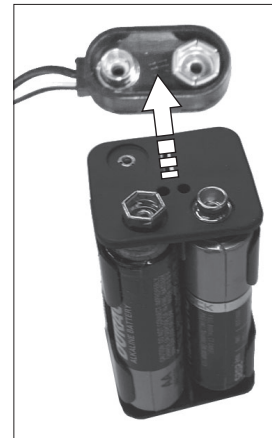

3. Replace the batteries with 4 AA **alkaline** batteries.
4. Reconnect the cable.
5. Put the battery holder back in its position ensuring that its wire does not touch the underside of the burner plate.
6. Reinstall the front trim.

**Using Handset Wall Holder**

Your fireplace equipment includes a wall holder to store the handset. If it hasn't been installed, refer to the instructions further on in this manual for the installation.



## Approvals and Codes

This appliance is certified to ANSI Z21.88/CSA 2.33 American National Standard/CSA Standard for *Vented Gas Fireplace Heaters* for use in Canada and USA.

The appliance complies with CSA P.4.1-15, *Testing method for measuring annual fireplace efficiencies*.

The installation must conform with local codes or, in the absence of local codes with the *National Fuel Gas Code, ANSI Z223/NFPA 54.1* or the *Natural Gas and Propane Installation Code CAN/CGA-B149.1*. Only qualified licensed or trained personnel should install the appliance.

The appliance, when installed, must be electrically grounded in accordance with local codes or, in the absence of local codes, with the *National Electrical Code, ANSI/NFPA 70* or the *Canadian Electrical Code, CSA C22.1*.

## Ratings

Model	INI	IPI
Gas	natural	propane
Altitude (ft)*	0-4 500 pieds*	
Input max. (Btu/h)	20,500	19,000
Input min. (Btu/h)	6,500	12,500
Manifold pressure (in w.c.)	3.5–3.9	10.3–10.7
Min. supply pressure (in w.c.)	5	11
Max. supply pressure (in w.c.)	10.5	14
Main burner injector (no.)	580	200
Pilot injector (no)	35	27
Min. by-pass screw	125	125

\*Tested to CGA - 2.17-91 *Gas fired appliances for use at high altitudes*. In USA, installations may require deration over 2000'—Check local codes.

## \*High Altitude Installations

Input ratings are shown in BTU per hour and are certified without deration for elevations up to 4,500 feet (1,370 m) above sea level.

For elevations above 4,500 feet (1,370 m) in USA, installations must be in accordance with the current ANSI Z223.1 and/or local codes having jurisdiction. Heating value of gas in some areas is reduced to compensate for elevation—consult your local gas utility to confirm.

For installations at elevations above 4,500 feet (1,370 m) in Canada, please consult provincial and/or local authorities having jurisdiction.

## Supply Gas

Heater engine 530INI uses natural gas.

Heater engine 530IPI uses propane gas.

The supply pressure must be between the limits shown in the *Ratings* table.

The supply connection is 3/8 inch NPT female located at the left side of the control valve.

The opening for the gas supply line is at the rear left corner of the appliance.

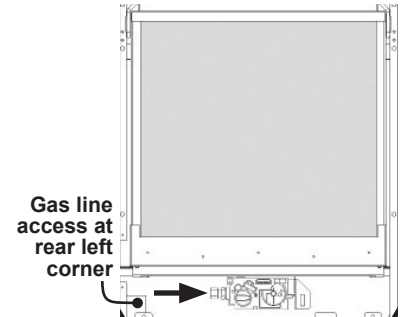

## Conversion Kits

The 530INI-IPI is supplied as natural gas or propane gas and is field convertible between fuels. See instructions packaged with the conversion kit for further information.

## Electrical

The unit does not require an electrical power source unless fitted with an optional circulating fan.

## Floor/Hearth

This appliance is approved for installation into existing solid-fuel burning fireplaces only. Combustible material such as plywood and so on may be used for leveling and shimming beneath the unit. This appliance does not require a hearth other than to support the weight of certain fronts.

## Front Trims

Various fronts are available for the 530 insert engine. This engine must be installed as an insert application.

**The front trim style affects the depth of insert cavity and position of the engine. A front trim kit is required for all applications and should be on site when the engine is installed.** 536/541/563 fronts require a closure plate (582/583CPB) to ensure proper positioning of the casting.

## Outdoor Conversion Kit

The 530 models are supplied standard for indoor applications and may be adapted for installation in specific “outdoor” applications protected from weather as defined in the GV60CKO outdoor conversion kit manual.

**This appliance is designed and approved as a supplemental heater and provides the potential for most energy conservation when used while attended. The use of an alternate primary heat source is advisable.**

This appliance may **ONLY** be installed in an existing unaltered, functioning solid-fuel burning fireplace with a working flue and constructed of non-combustible material.

This appliance may be installed in outdoor, weather-protected environments as defined in the GV60CKO Outdoor Conversion Kit instruction manual.

**DO NOT** install into combustible construction. This appliance is **NOT APPROVED** for installation with a zero clearance kit.

**⚠ WARNING**

Some materials or items, although safe, may discolor, shrink, warp, crack, peel, and so on because of the heat produced by the fireplace. Avoid placing candles, paintings, photos, and other items sensitive to heat around the fireplace.

**⚠ WARNING**

**HOT HEARTH / FLOOR!** The hearth or floor in front of the fireplace may become very hot when the fireplace heats. Do not use the hearth as a seat or shelf. Solid wood flooring in front of the fireplace (if allowed) may shrink during the heating season due to heat.

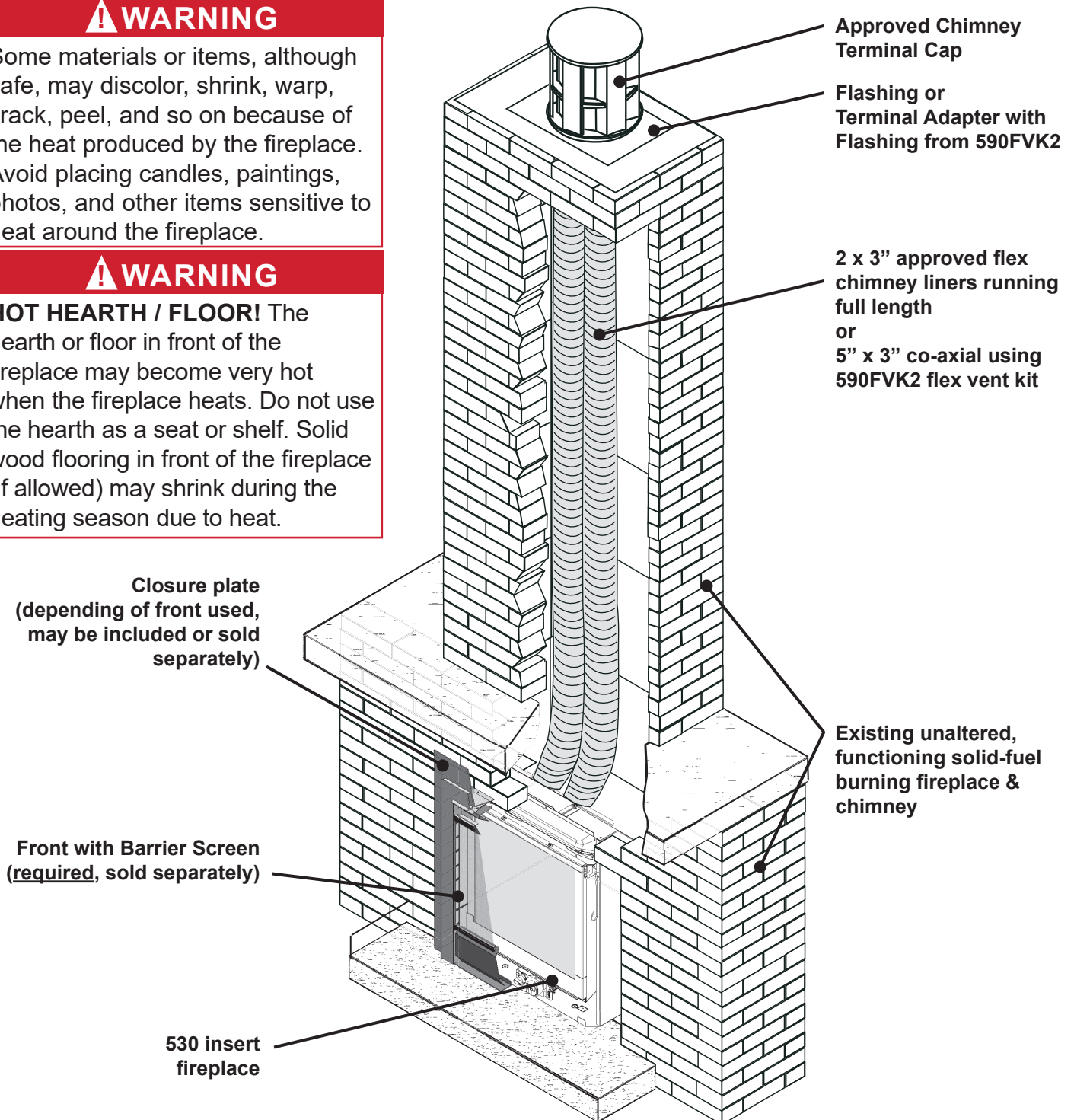

**Co-Linear—as supplied**  
**Venting options**

Rear view

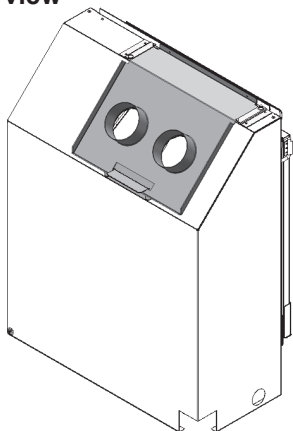

**Note:** 536/541/563 fronts require a closure plate (582/583CPB) to ensure proper positioning of casting. Other fronts are supplied with a backing plate included.

**Co-linear appliance, as supplied**  
**(2 x 3" diameter liners)**

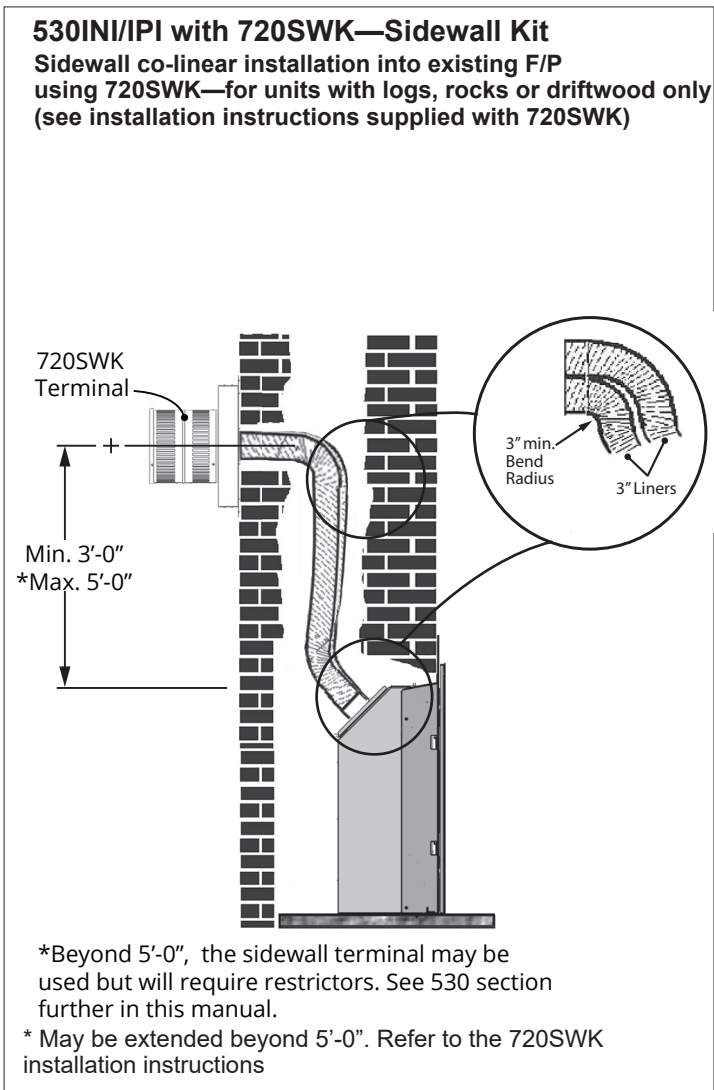
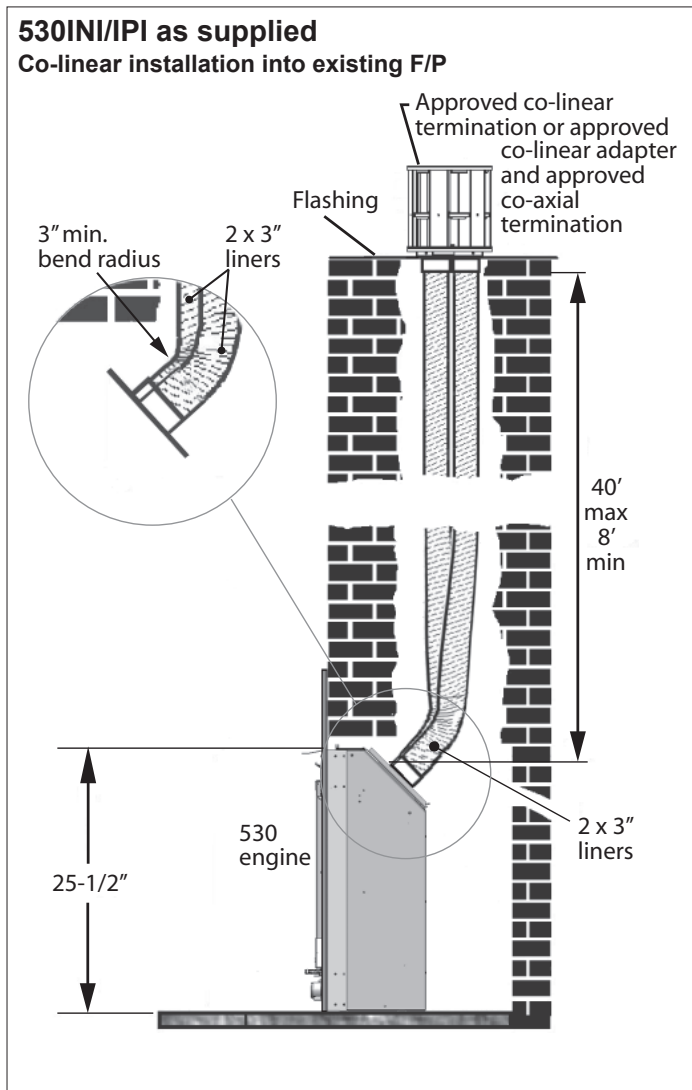

Convert to Co-Axial

Venting options

Rear view

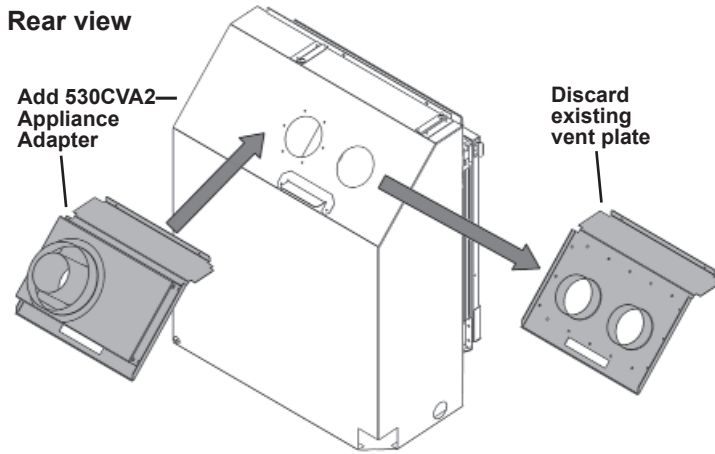

Add optional 530CVA2 for co-axial venting (5" x 3" diameter liners)

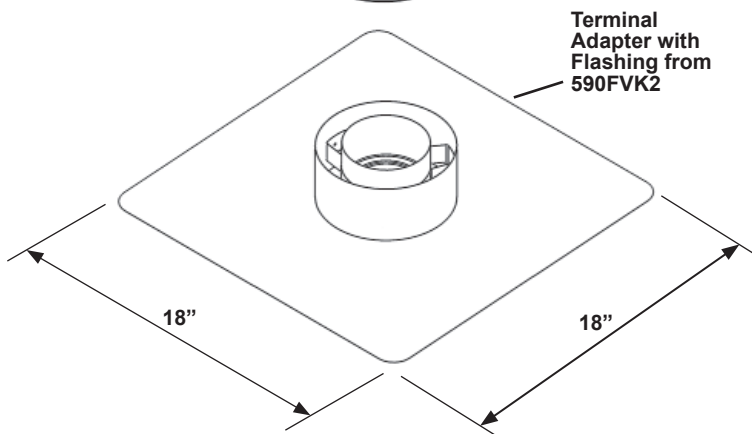
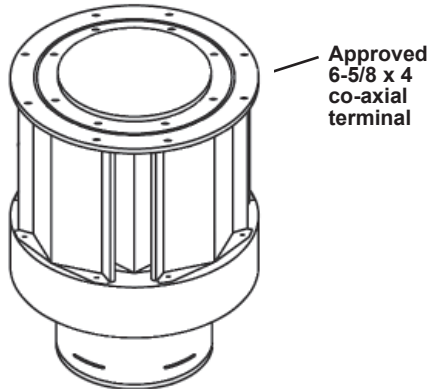

530INI/IPI with 530CVA2—Co-axial Appliance Adapter

Co-linear installation into existing F/P

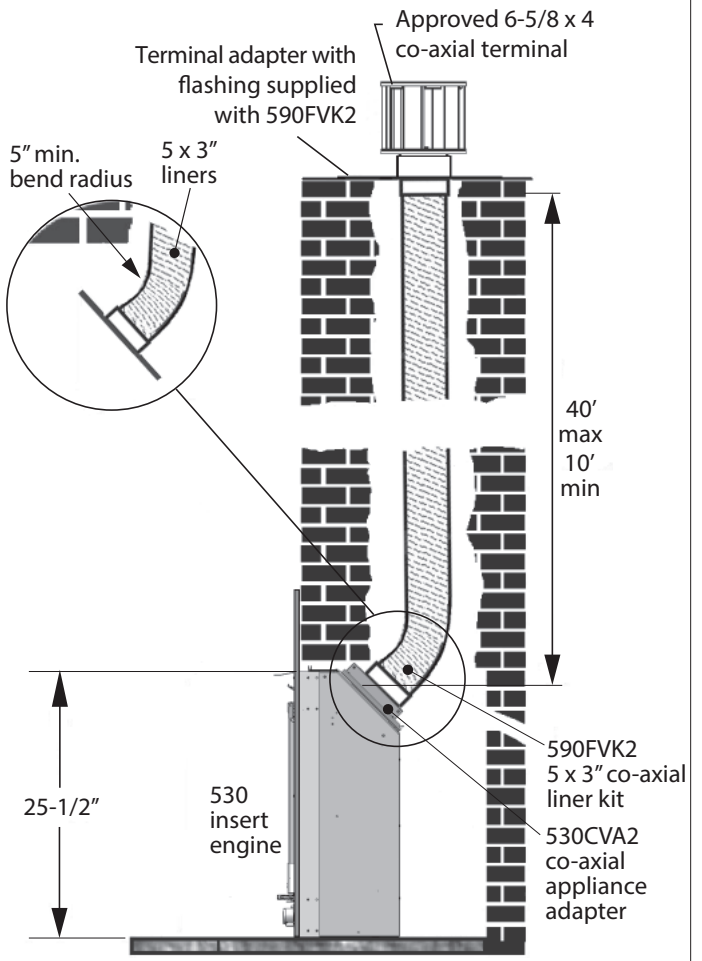

## Dimensions

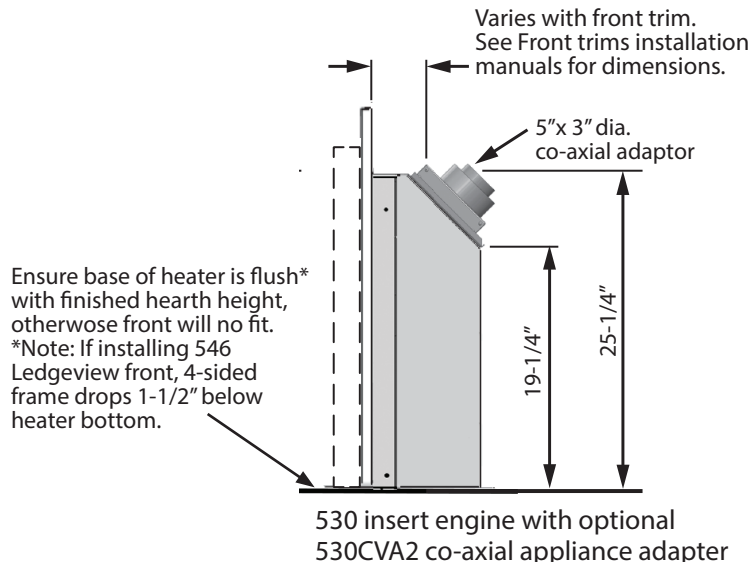
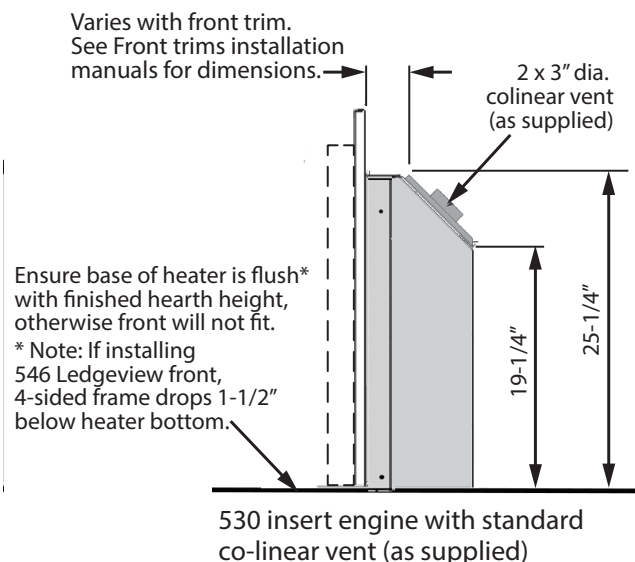
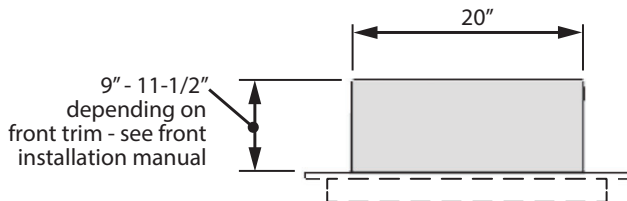

## Cavity

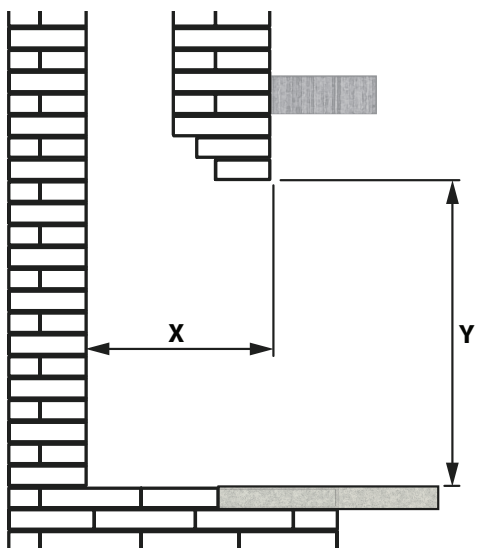

Check that masonry step does not interfere with install dimensions or vent pipe.

If mantel is combustible, see section *Clearances* for allowable clearances.

Minimum width of fireplace opening at front: 20-1/2" (521 mm)

X = 9"–11-1/2" (229–292 mm)—varies with front trim options

Y = 25-1/2" (648 mm)

**Note:** Using 546 Ledgeview front requires additional 1-1/2" (38 mm) cavity height.

## Clearances

### ⚠ WARNING

Some materials or items, although safe, may discolor, shrink, warp, crack, peel, and so on because of the heat produced by the fireplace. Avoid placing candles, paintings, photos, and other items sensitive to heat around the fireplace.

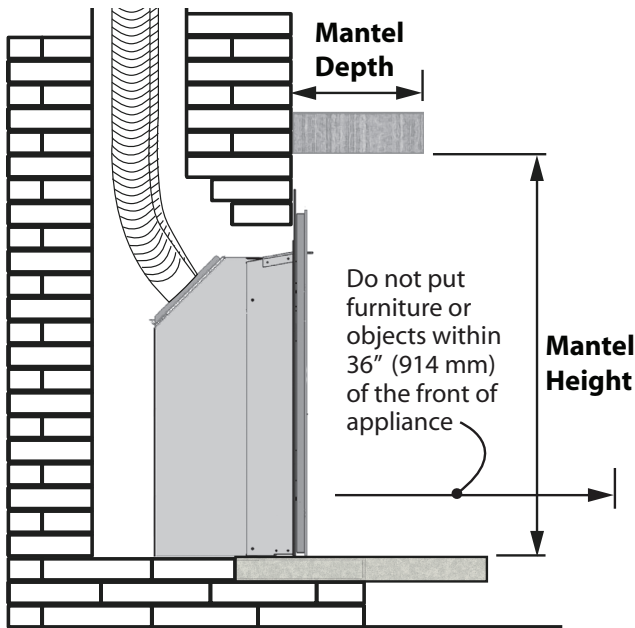

### Combustible Mantel Clearances

See Front trim installation manual.

### Finishing Materials

**Combustible materials:** Materials made of or surfaced with wood, compressed paper, plant fibers, plastics, or other material that can ignite and burn, whether flame proofed or not, or plastered or unplastered.

**Non-combustible materials:** Material which will not ignite and burn. Such materials are those consisting entirely of steel, iron, brick, tile, concrete, slate, glass or plasters, or any combination thereof.

Materials that are reported as passing ASTM E 136, Standard Test Method for Behavior of Materials in a Vertical Tube Furnace at 750 °C

### ⚠ WARNING

**HOT GLASS!** The use of a screen in front of the glass is highly recommended particularly in households with children.

### ⚠ WARNING

**HOT HEARTH / FLOOR!** The hearth or floor in front of the fireplace may become very hot when the fireplace heats. Do not use the hearth as a seat or shelf. Solid wood flooring in front of the fireplace (if allowed) may shrink during the heating season due to heat.

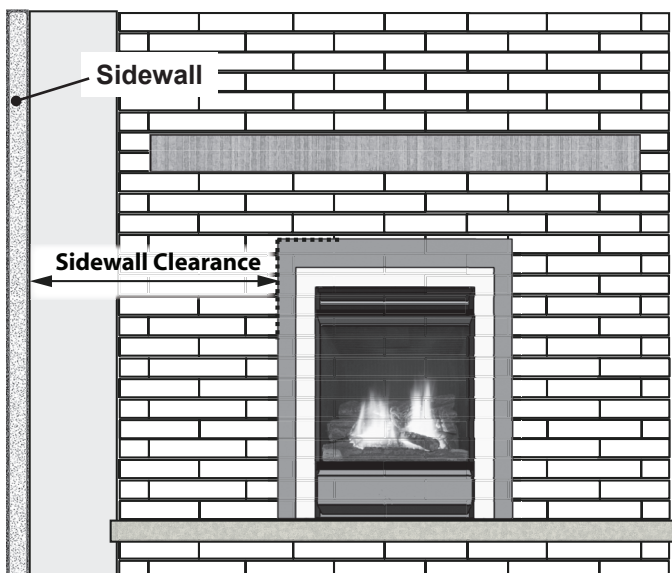

### Sidewall Clearances

See Front trim installation manual.



## Typical Vent Installation

See the *Approved Venting Components* list on page 45 of this manual.

## Vent Location

The vent terminal must be located through the roof. This direct vent appliance is designed to operate when an undisturbed airflow hits the outside vent terminal from any direction. Check local codes for allowable vertical vent termination.

## Venting Table

<b>Maximum vertical height</b>	<b>40 ft (measured to bottom of termination)</b>
<b>Minimum vertical height</b>	<b>10 ft (measured to bottom of termination)</b>
<b>Maximum horizontal run</b>	<b>4 ft (measured center to center of pipe)</b>
<b>Maximum offset angle</b>	<b>45° (sweeping bend to allow for obstructions)</b>

## Venting Notes

Where possible, avoid splicing flex pipes. If splices are required, use an approved connector and seal joints with *RTV high temp sealant*.

Four feet horizontal is permissible to allow for routing around masonry projections. Do not bend flex pipe over a 45 degrees radius.

1. Co-linear venting may be converted to solid 4" x 6-5/8" co-axial venting at the top of the existing solid-fuel burning chimney as necessary where the existing chimney has deteriorated and been removed. The conversion must be done using approved components (see page 45) and proper vent clearances to combustibles must be maintained.
2. Flex liners may only be installed into solid-fuel burning fireplaces and chimney systems (no combustible construction).
3. The appliance must not be connected to a chimney flue serving a separate solid-fuel burning appliance.

## Note

This appliance may also be vented using the following optional methods (see installation instructions packaged with optional kits):

- 720SWK—Co-linear sidewall kit

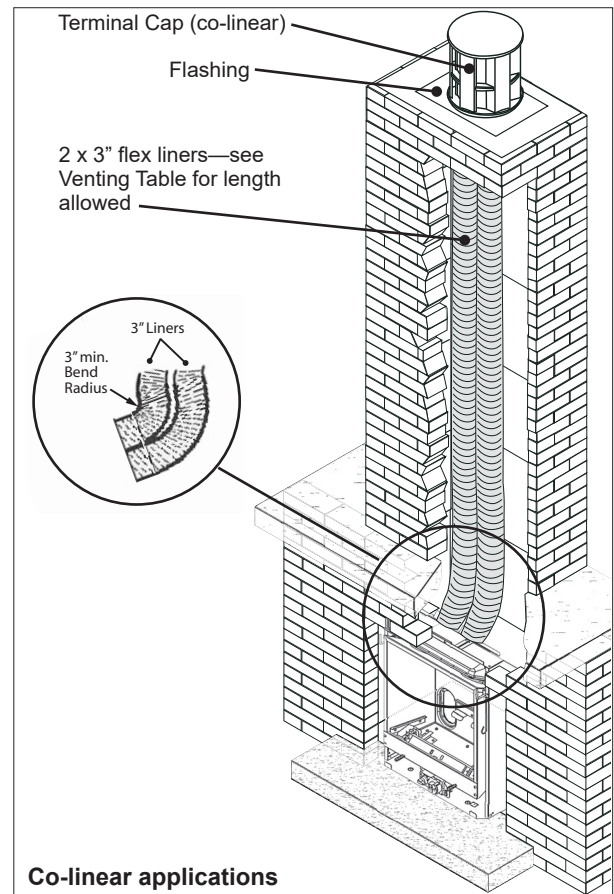

**Co-linear applications**

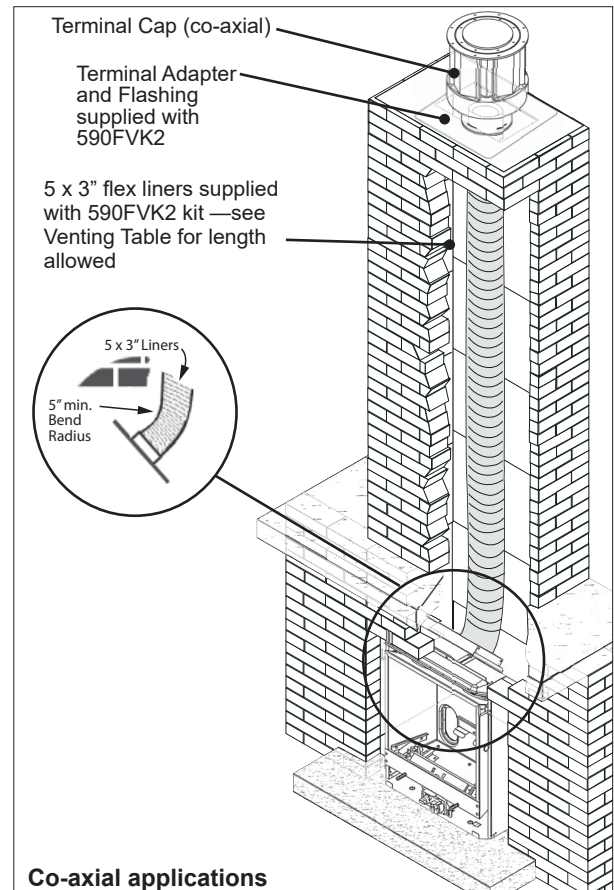

**Co-axial applications**

**Attaching Air Restrictors**

**Appliances with more than 10'-0" Vertical Vent Rise Only**

*No restrictors are required for appliances which that have less than 10'-0" vertical run. If installing an appliance which has less than 10'-0" vertical vent pipe rise, ignore this stage.*

Two restrictor sets, like the one shown right, are supplied with each 530 engine unit. The restrictors cover part of the **inlet air openings** in the firebox **rear wall** on each side of the brick support. **Do NOT install the restrictors in the roof of the firebox!**

Each set is assembled with an adjustable piece which can be moved to different positions depending of the vent configuration. See the table below to find out which position is optimal for each type of installation.

- To fit the restrictors, loosen the two center screws of the left and right inlet ports. Place the restrictor assembly under the screw heads and tighten the center screws.
- To set the adjustable restrictor piece, loosen the two screws, position the adjustable piece according to the diagram below and tighten the screws.

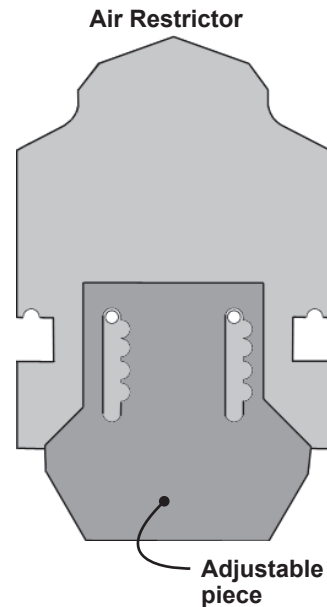

Vertical vent pipe run	Restrictor setting	
	Logs/Rocks	Coals
10–40 ft (3.05–12.2 m)		

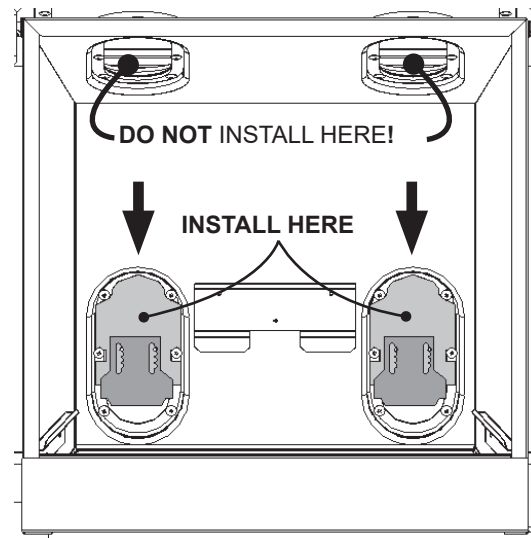

Install restrictors in the **inlet air openings in the firebox rear wall** behind the rear log support.

## Installation Planning

### Installer—READ THIS FIRST

#### 1. YOU NEED TO KNOW FROM THE HOMEOWNER:

- What accessories (front trim, closure plate, etc.) will be installed with this fireplace;
- What is the venting configuration
- What is the required cavity size and hearth finish - see front installation manuals;
- What are the optional accessories to be installed with this fireplace if any.

2. Unpack the appliance, removing all items packed inside and around the appliance.
3. Check that you have everything, using the Pack Content sheet. Also check that you have the front, firebox panels and fuel bed, optional accessories.
4. Carefully read the Installer's Checklist included with the fireplace's documentation for the installation sequence.

Only qualified licensed or trained personnel should install this appliance.

### WARNING

Optional electrical accessories ARE NOT ALLOWED when adapting appliance for outdoor use.

## Existing Fireplace Preparation

A few points must be considered before installing the 530 insert into an existing fireplace cavity. Generally, no modifications are allowed to the existing fireplace that will compromise the integrity of the existing fireplace. Components that are bolted or screwed on such as dampers or baffles may be removed to accommodate the installation of the 530 insert engine. **Cutting away any sheet metal parts of the existing fireplace to accommodate the installation of the 530 insert is prohibited.** Check with local authorities if in doubt.

### Clean Fireplace and Chimney

Have the chimney swept and the fireplace cavity including ash dumps and clean-outs cleaned before installing the 530 insert heater and vent liners. Any creosote or soot residue remaining in the fireplace cavity chimney or clean-out may cause odors or stains once the 530 insert is installed. Consult with chimney sweep for information on how best to clean.

### Existing Dampers

Factory-built, zero-clearance fireplaces will require the damper to be removed in order to install the vent liners. These dampers are usually bolted into place. Dampers in masonry fireplaces must be fixed open and may remain in place.

### Ash Retaining Curbs

Some fireplaces (particularly factory-built) have a raised curb at the front edge to retain ashes. Check the dimensions carefully to ensure the 530 insert engine will fit behind any raised curb (some curbs may be removed separately from the refractory base).

## Existing Fireplace Preparation

### Gas Line Routing

Plan the routing of the gas line before proceeding. Utilize the existing hole for the gas line. If the factory-built fireplace has no access hole, carefully drill an access hole of 1.5 inch (38 mm) or less through the lower sides or bottom of the firebox. The access hole must be plugged with non-combustible insulation after the gas supply line has been installed. See *Dimensions* section for detailed location of gas inlet. Also, take into consideration whether or not a fan or shut-off valve will interfere when planning routing of the gas line.

### Existing Glass Doors and Wire Screens

**Existing glass doors must be permanently removed** prior to installing the 530 insert.

### Combustible Mantels

Combustible mantel clearances should conform to those required for the original solid-fuel fireplace into which the 530 insert is being installed.

### Attach Warning Conversion Plate to Existing Fireplace (label supplied loose with 530 insert heater)

Attach the “This fireplace has been converted...” label **to the existing fireplace** using screws or other mechanical means and store any removed parts in back of the existing fireplace for future use.

## Installation

### Unpack the appliance

**Beware of sharp edges! Wear gloves!**

1. Unpack the appliance.
2. Unpack any loose items from around the appliance and check against the Pack Content list provided in the documentation package.
3. Remove the window and set aside in a safe place to avoid damage—see next page.
4. **Verify that you have all the components required for the installation, including:**
  - ***fuel bed and panels;***
  - ***surround/doors/fret;***
  - ***venting components and accessories;***
  - ***blower and electrical components for blower installation if used.***

## Remove Window

1. Release the top of the window by pulling forward the two levers at the top corners.
2. Unscrew the two spring-loaded bolts securing the bottom of the window.
3. Carefully lift the window. Keep the window and bolts in a safe place.

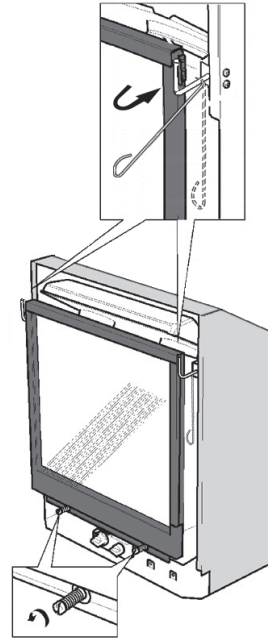

## Remove Burner Module

It may be desirable to remove the burner module to gain access for gas fitting, to install a fan kit, or to fasten the unit to the floor of the fireplace cavity.

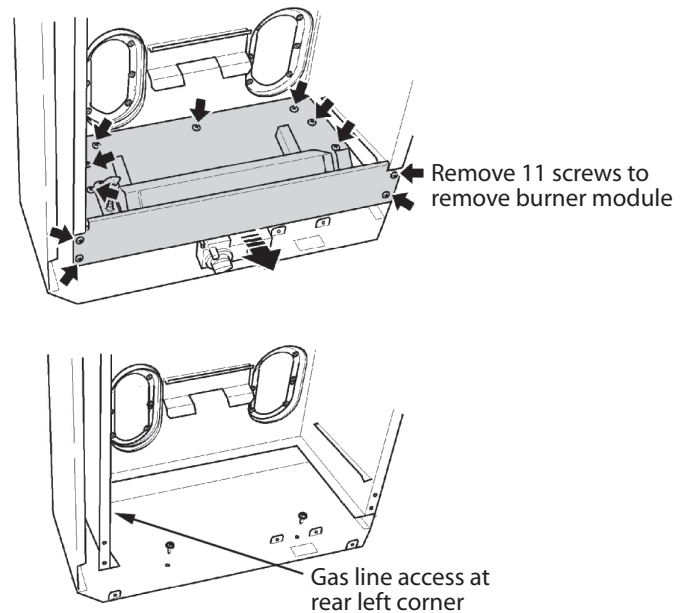

## Installation

### Co-Linear Applications (2 - 3" liners)—Connect Venting

**IMPORTANT:** This appliance's venting system is room sealed and therefore, does not require room air to be used in the combustion process.

1. Rough-in two 3" diameter vent liners into the existing chimney system from the roof. Be careful not to tear or damage the liners in the process. It may be easier to install both liners at the same time rather than one at a time. Leave plenty of liner at the bottom to facilitate the connection of the liners to the vent slider. **It is best to leave the top termination until later.** Designate and mark the top and bottom of one liner as "EXHAUST" to avoid confusion later.
2. Release the two screws retaining the vent slider to the front of the firebox. Remove the slider from the firebox by sliding it towards the back of the firebox.
3. Fit the two liners ensuring that the **exhaust liner is connected to the identified "EXHAUST" vent collar**. Secure liners to collars with hose clamps (included) and 2 tapping screws per liner.
4. Slide the firebox onto the vent slider in the cavity taking care not to damage the liners. **Make sure that the rear edge of the slider is hooked over the cleat on the firebox.** Secure the vent slider to the front of the firebox with two screws removed earlier.
5. From the roof, pull the liners and fit the flashing.
6. Fit the terminal cap ensuring that the **exhaust liner is connected to the exhaust vent collar**. Secure with 8 screws provided.
7. Seal the terminal and flashing from water penetration as required.

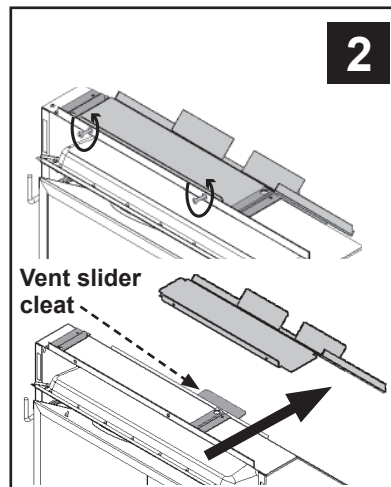

**⚠ WARNING**  
 Failure to position the parts in accordance with these diagrams or failure to use only parts specifically approved with this appliance may result in property damage or personal injury.

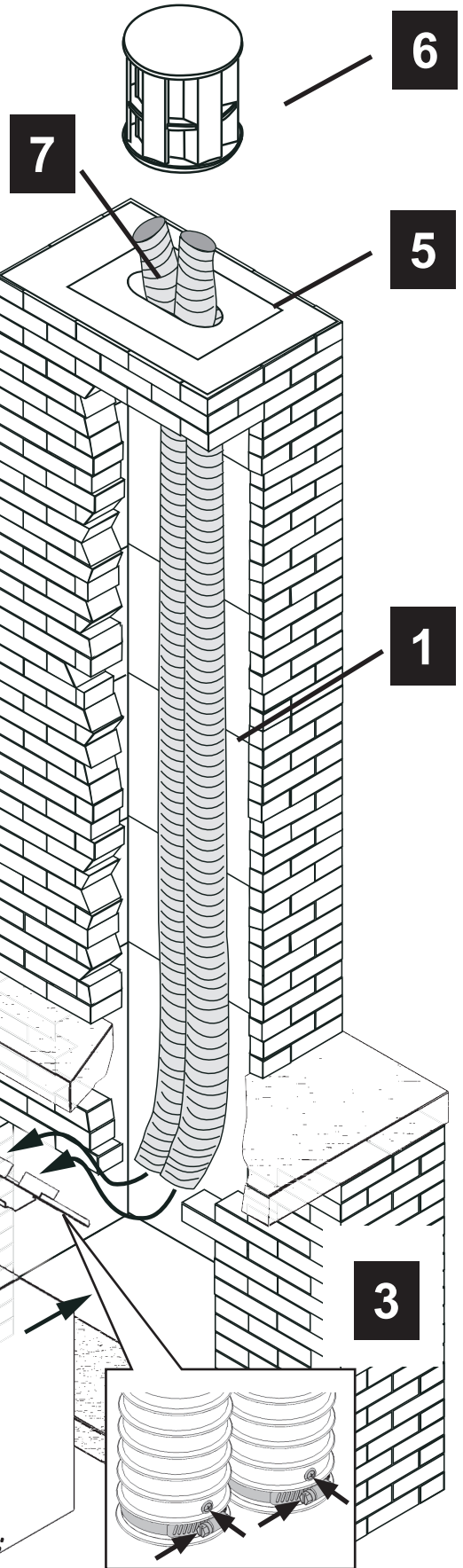

## Co-Axial Applications (3" x 5" liners using 590FVK2 and 530CVA2)—Connect Venting

**IMPORTANT:** This appliance's venting system is room sealed and therefore, does not require room air to be used in the combustion process.

1. Stretch 3" and 5" liners from kit 590FVK2 individually to required length. Insert the 3" liner inside the 5" liner and rough-in vent liners into the existing chimney system from the roof. Be careful not to tear or damage the liners in the process. Verify there is plenty of liner at the bottom to facilitate the connection of the liners to the vent slider so you will not need to stretch more later.
2. Trim 590FVK2's Terminal Adapter & Flashing as required to suit top of chimney and fold a drip edge if desired.
3. Trim ends of liner if necessary and fasten to collars on the underside of the 590FVK2's terminal adapter using sheet metal screws and gear clamps provided. Ensure liners are well secured and will not fall down the chimney.
4. Apply a bead of sealant to top of chimney and seat 590FVK2's flashing onto sealant.
5. Release the two screws retaining the vent slider to the front of the firebox. Remove the slider from the firebox by sliding it towards the back of the firebox.
6. Fit the two liners. Secure with hose clamps (included) and 2 tapping screws per liner (inner liner first, then outer).
7. Slide the firebox onto the vent slider in the cavity taking care not to damage the liners. **Make sure that the rear edge of the slider is hooked over the cleat on the firebox.**

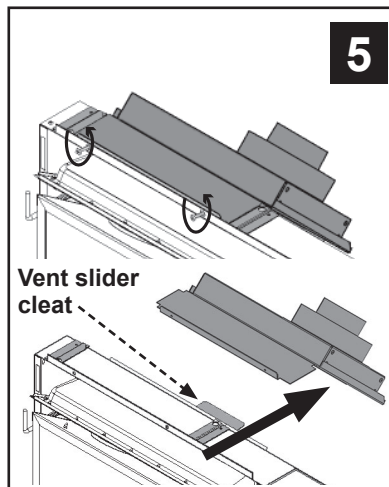

**⚠ WARNING**  
 Failure to position the parts in accordance with these diagrams or failure to use only parts specifically approved with this appliance may result in property damage or personal injury.

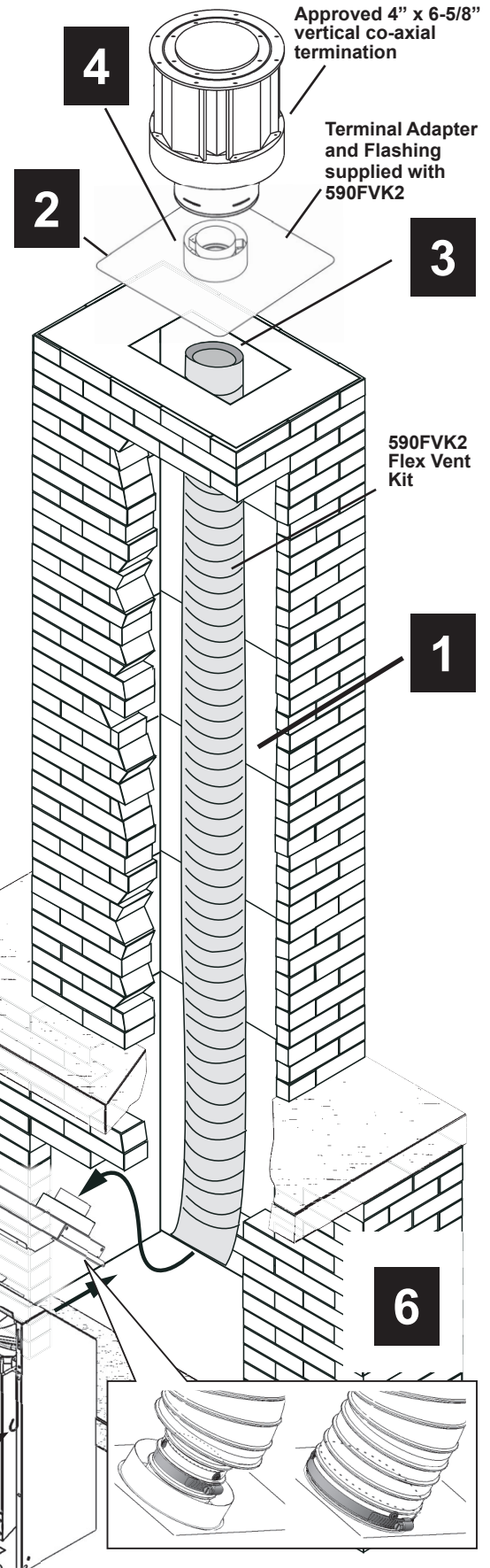

**Connect Gas Supply**

- It's preferable to rough-in the gas line at this point before proceeding with the firebox installation.
- The appliance is supplied for supply gas connection at the control valve. Supply line connection to the control valve of the appliance is 3/8 inch NPT (female).  
Take care not to apply torque to the valve. An isolating valve may be fitted within the appliance case. Be aware that the supply pipe should follow routing to clear the remote receiver or optional fan.
- Use only new black iron or steel pipes, CSST, or copper tubing if acceptable—check local codes. *Note that in USA, copper tubing must be internally tinned for protection against sulfur compounds.*
- Unions in gas lines should be of ground joint type.
- The gas supply line must be sized and installed to provide a supply of gas sufficient to meet the maximum demand of the appliance without undue loss of pressure.
- Sealant used must be resistant to the action of all gas constituents including LP gas. Sealant should be applied lightly to male threads to ensure excess sealant does not enter gas lines.
- The supply line should include a **manual shut-off valve** and **union** to allow the appliance to be disconnected for servicing.

**Pressure test the supply line for leaks.**

- **The appliance and its individual shut-off valve must be disconnected from the gas supply piping system during any pressure testing of that system at test pressures in excess of 1/2 psig (3.5kPa).**
- **The appliance must be isolated from the gas supply piping system by closing its individual manual shut-off valve during any pressure testing of the gas supply piping system at test pressures equal to or less than 1/2 psig (3.5kPa).**
- Failure to either disconnect or isolate the appliance during pressure testing may result in regulator or valve damage. Consult your dealer in this case.
- The minimum supply pressure is given in *Specifications* section of this manual.
- All piping and connections must be tested for leaks after installation or servicing. All leaks must be corrected immediately.

- When testing for leaks:
  - Make sure that the appliance is turned off.
  - Open the manual shut-off valve.
  - Test for leaks by applying a liquid detergent or soap solution to all joints. Bubbles forming indicate a gas leak.

**⚠ WARNING**  
**NEVER use an open flame to check for leaks!**  
**Correct any leak detected immediately.**

- The pressure test tapping locations are shown in figure below. A built-in non-adjustable regulator controls the burner manifold pressure. The correct pressure range is shown in the table in the *Specifications* section of this manual. The pressure check should be made with the burner alight and at its highest setting. See *Lighting Instructions* section for full operating details.

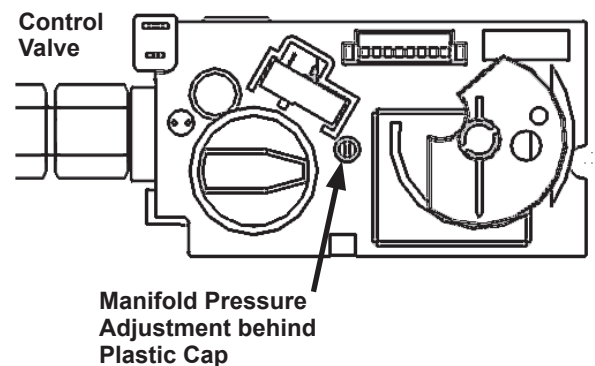
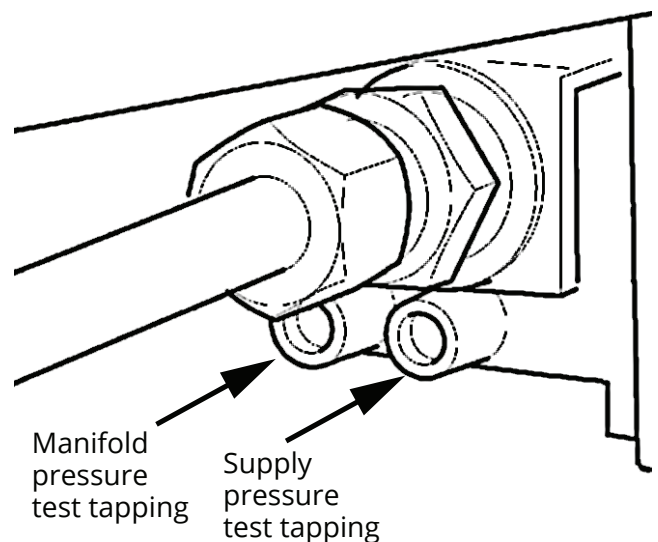



## Install Ceramic Liners (Logs or Coals only)

The 530LSK and CSK fuel beds include a set of reversible liners. One side shows the brick pattern and the reverse side shows a black vertical fluted pattern. Follow the instructions below to install the liner set on the chosen side.

- **530RSK Rock Set liners.** For ceramic liners installation with the 530RSK, see *Install the 530RSK—Rock Set and Liners* section in this manual.
- **530DWK Driftwood Kit liners.** For ceramic liners installation with the 530DWK, see *Install the 530DWK—Driftwood Kit and Liners* section in this manual.
- **580RGL Reflective Glass Liner Set.** To install the 580RGL, see the installation instructions provided with the kit.
- **567FGP Top Grille.** At this point, you can install the 567FGP, if used (logs, rocks or driftwood versions only). The 567FGP Top Grille is sold separately except when included with front trim—see front trim installation manual.

1. Locate the ceramic rear wall in the channel at back of the firebox and flat against the back of the firebox.
2. Locate the sidewalls in the channels at the sides of the firebox.
3. Remove two screws from under the top front of the firebox. Using these screws fit the port cover.

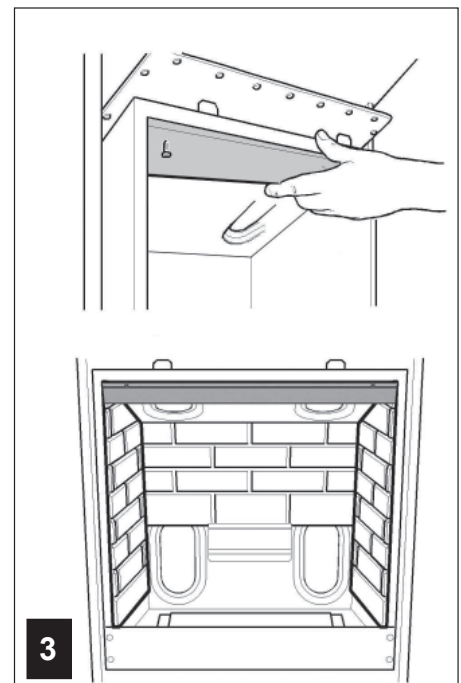
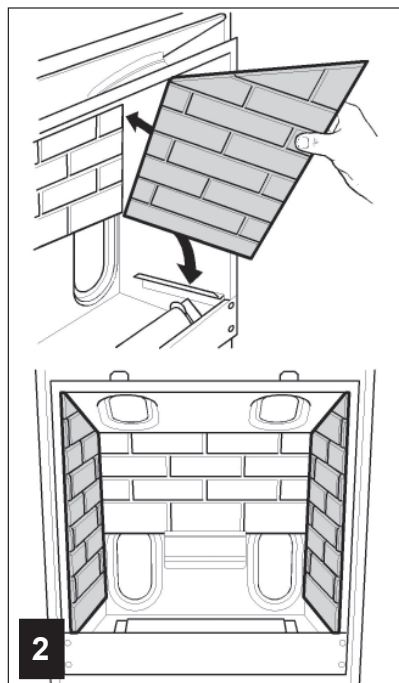
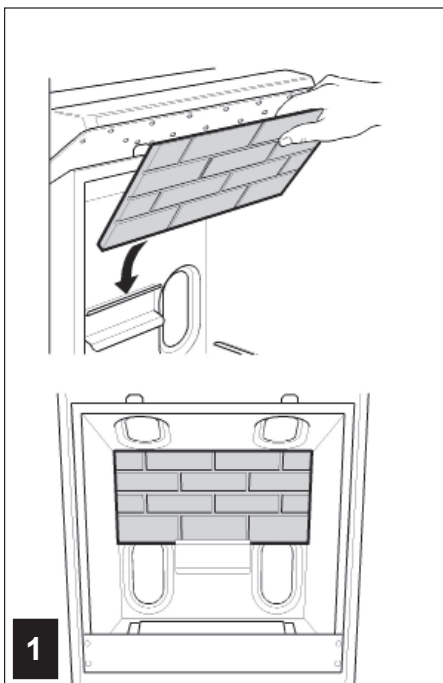

## Installation

### Install the 530LSK—Traditional Logs Set

1. Place the base log on the supports in the firebox and against the support at the firebox back.
2. Locate the rear upper log on the two ceramic pins at the rear of the base log.
3. Place the front log behind the metal strip at the front of the firebox.
4. Locate the right middle log on the pin in the right hand side of the base log .
5. Locate the left side log on the ceramic pin on the left hand side of the base log. Rest the narrow nose of this log on the projection at the front center of the base log—*ensure that the narrow nose does not rest on the burner.*
6. Locate the right side log on the pin in the front log and rest the nose of this log on the projection on the base log—*ensure that the nose does not rest on the burner.*

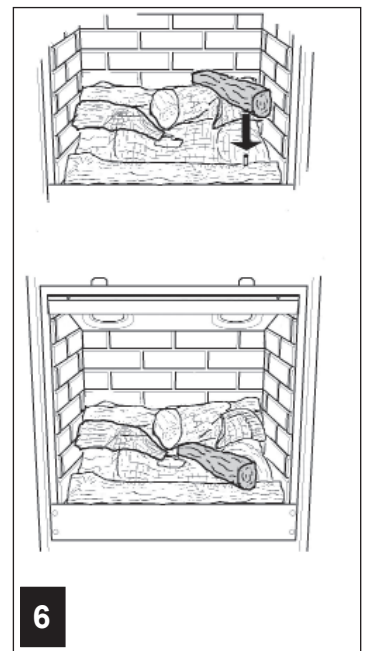
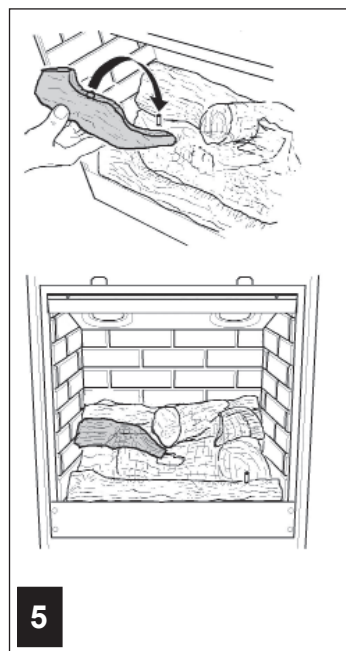
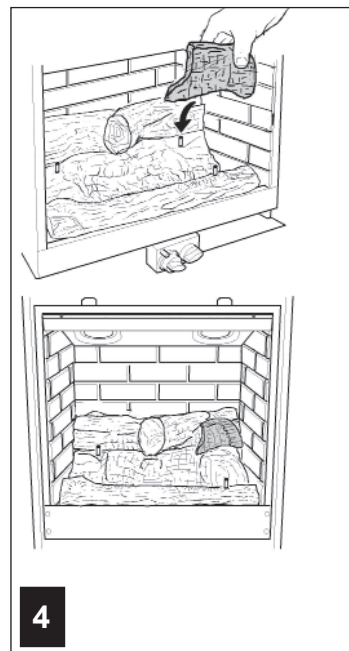
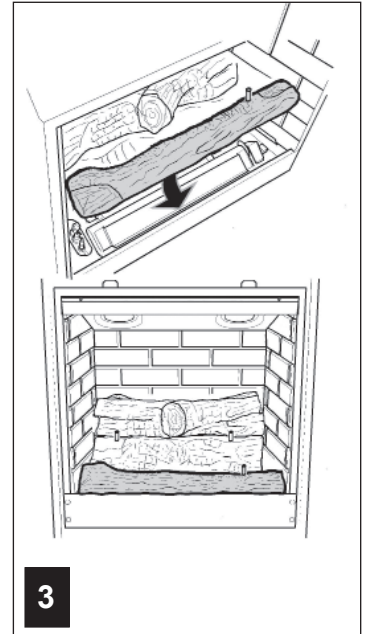
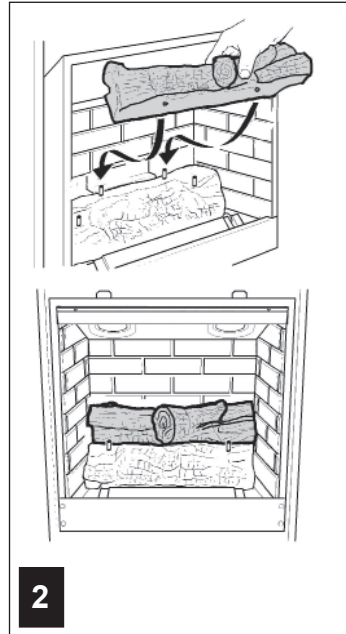
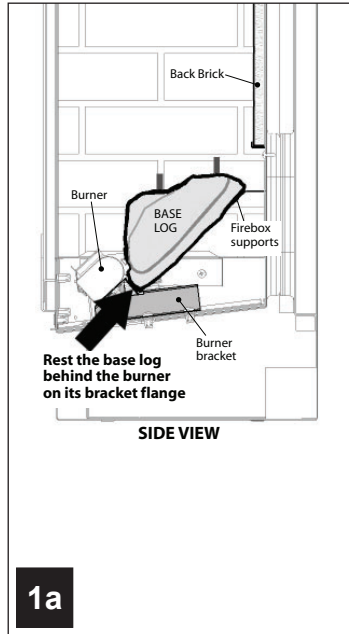
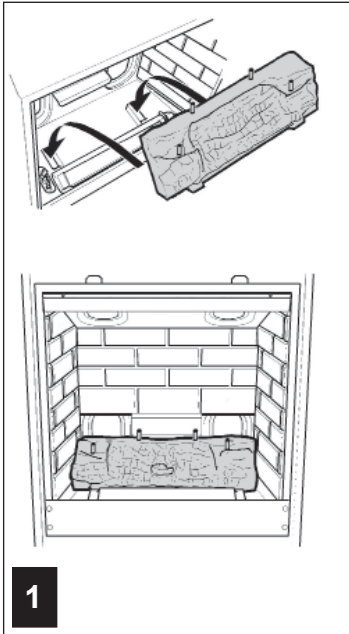

# Installation

## Install the 530CSK—Coal Set

1. Place the base coal on the supports in the firebox and against the firebox back.
2. Place the left front coal in position behind the metal lip at the front of the firebox. The side projection on this coal should be near the middle front of the firebox.
3. Place the right front coal behind the metal lip at the front of the firebox. Its left side should rest over the projection on the left front coal.
4. The center right coal has letter “R” embossed underneath. Place this coal behind the front right coal.
5. The center left coal has letter “L” embossed underneath. Place this coal behind the front left coal.

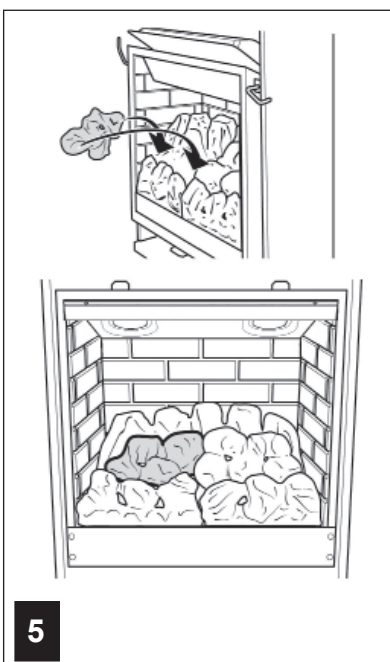
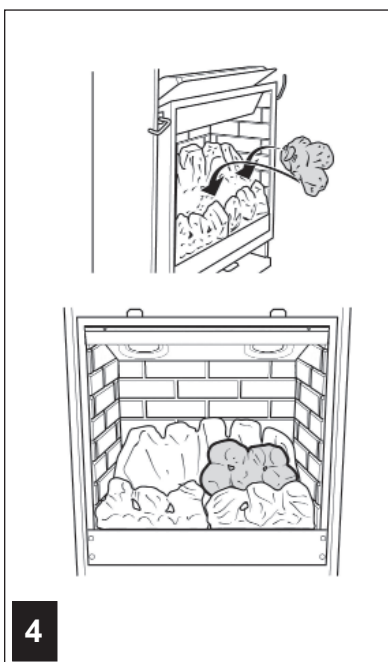
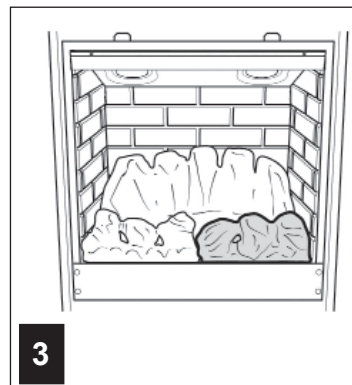
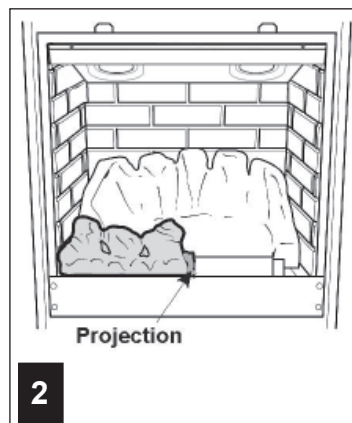
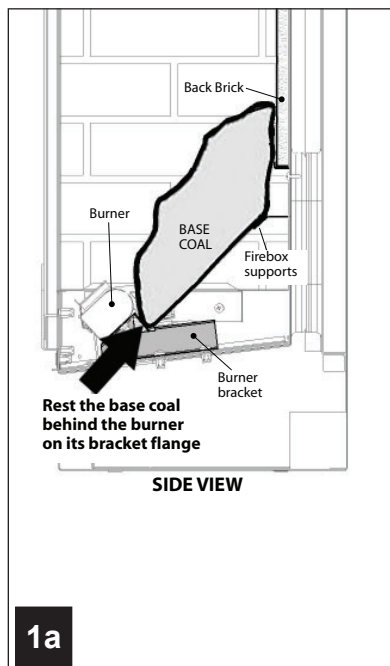
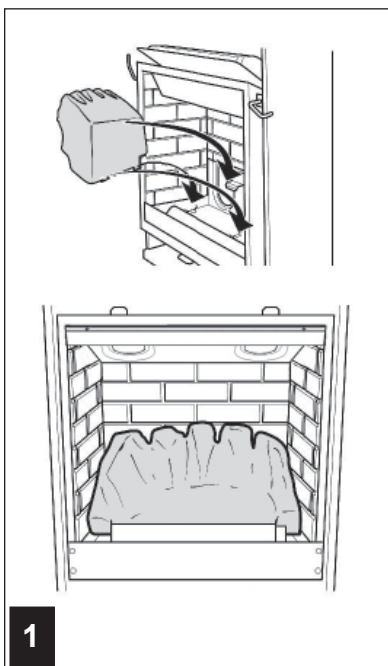

# Installation

## Install the 530RSK—Rock Set and Liners

Unpack each piece of the ceramic rock set carefully to avoid damages. The set contains:

- Ceramic platform
- Left and right side reversible ceramic panels
- Rear panel support
- Rear fluted panel
- Ceramic base for rocks
- 12 ceramic rocks

**580RGL Reflective Glass Liner Set.** To install the 580RGL, see the installation instructions provided with the kit.

## Install liners

1. Remove the rear panel support inside the firebox (3 screws).
2. Replace with the rear panel support provided with the 530RSK kit and fix it (3 screws).

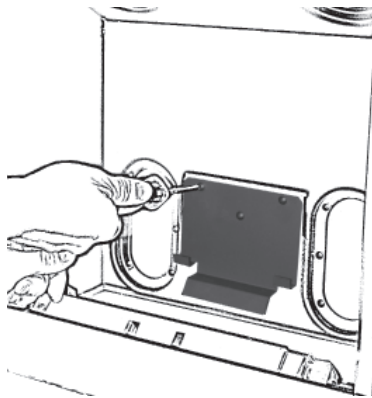

**If installing the 567FGP Top Grille (sold separately), fit it now.** See instructions supplied with the grille.

3. Place the rear panel on the rear support as indicated. Hold in place and go to next step.

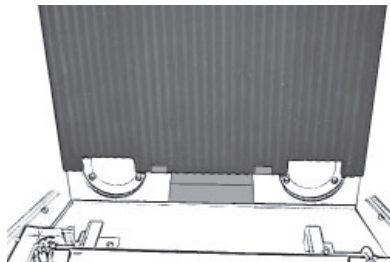

4. Place the left and then the right panels in the firebox showing the black fluted sides.

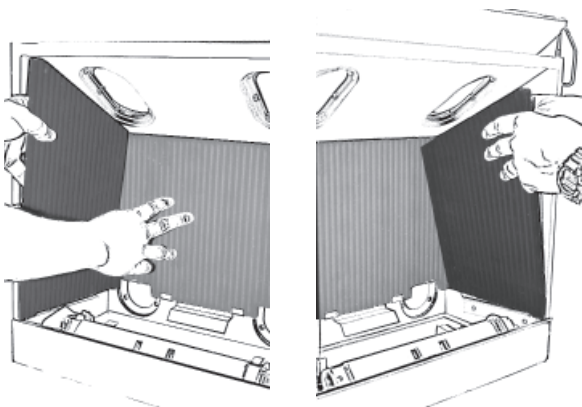

## Install rock base & platform

1. Place the rock base behind the burner. The two protrusions in front of the base should rest on the burner mounts as indicated.

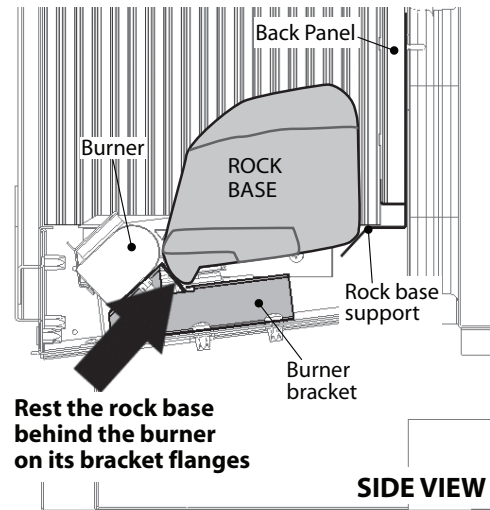
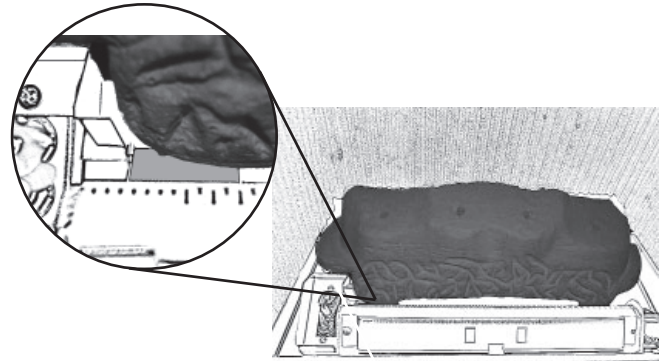

2. Place the ceramic platform over the burner and around the rock base with the pegs on the top. The rear part of the platform should overlap the edges of the rock base on each side.

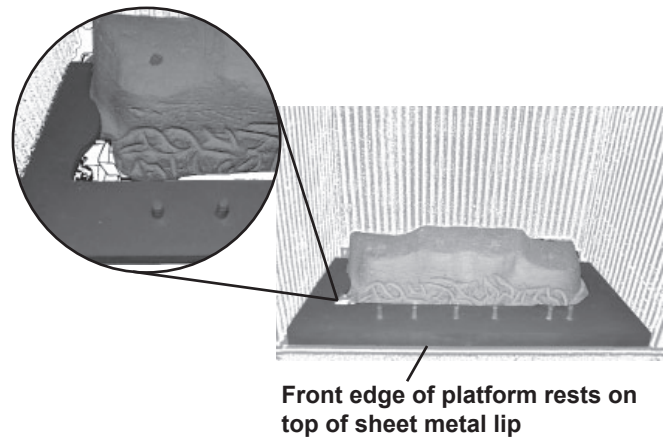

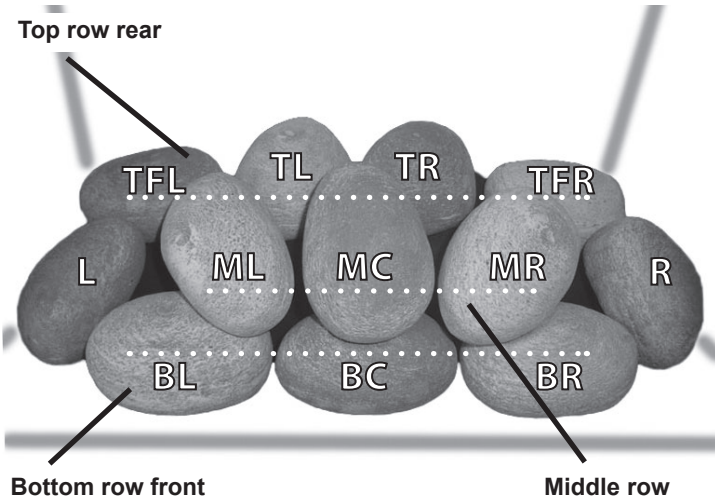

Rock ID	Description	Other markers	Position in the firebox
TFL	Top far left	1 peg under	Top row rear
TL	Top left	1 peg under	Top row rear
TR	Top right	1 peg under	Top row rear
TFR	Top far right	1 peg under	Top row rear
BL	Bottom left	2 holes under, 1 peg above	Bottom row front
BC	Bottom center	2 holes under, 1 hole above	Bottom row front
BR	Bottom right	2 holes under, 1 peg above	Bottom row front
ML	Middle left	1 hole under	Middle row
MC	Middle center	1 peg under	Middle row
MR	Middle right	1 hole under	Middle row
L	Left	—	Left side
R	Right	—	Right side

### Install rocks

To get the optimal flame effect, it is important to place the rocks in their appropriate position. Each rock is embossed underneath with letters and an arrow indicating the position of the rock. **The arrows point to the front of the fireplace when the rock is installed.**

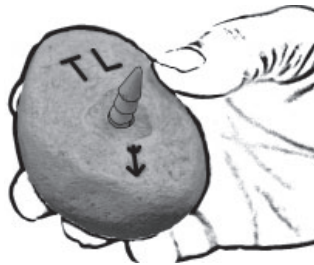

See the image and table at the top of the page to help you with the identification and position of the rocks.

1. Identify the rocks **TFL, TL, TR, and TFR**. These rocks have pegs that fit in the holes on the top of the rock base. Install these rocks positioning them so that the arrow embossed underneath point to the front of the fireplace.
2. Identify the rocks **BL, BC, and BR**. These rocks have two holes that fit on the pegs of the ceramic platform. Install these rocks positioning them so that the arrow embossed underneath point to the front of the fireplace.

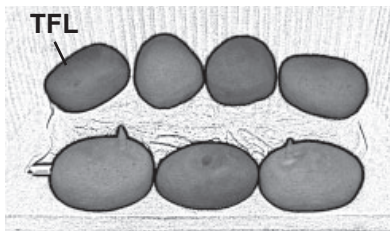
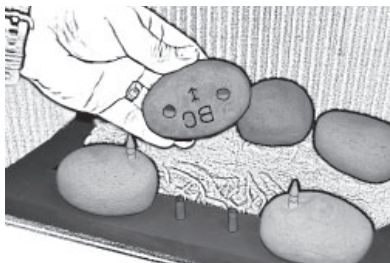

3. Identify the rocks **ML, MC, and MR**. Those rocks have pegs that fits in the holes on the top of the rocks on the front row. Install those rocks positioning them so that the arrows underneath point to the front of the fireplace.

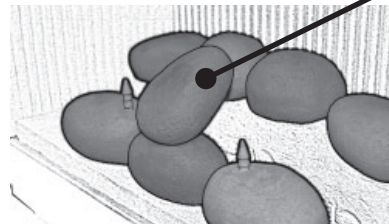
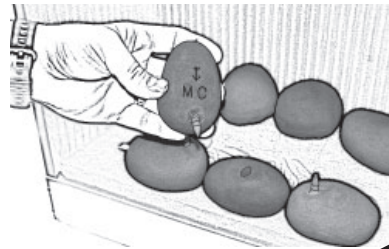

This rock is suspended and does not rest on the rocks of the row behind it.

4. Identify the rocks **L and R**. Those rocks don't have any peg or hole. Install those rocks as indicated, at the left and right of the rock pile positioning them so that the arrows underneath point to the front of the fireplace. The rock rests against the other rocks and is at an angled position. *Make sure that the TFL rock at the rear left is in the proper angle*—see image in step 2. See the image at the top of the page. You must be able to see the edge of the platform under the L rock (at left) as indicated below.

The edge of the platform is visible under the rock

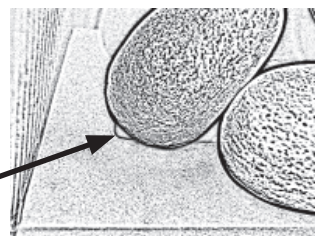

## Installation

### Install the 530DWK—Driftwood Kit and Liners

Unpack each piece of the ceramic driftwood set carefully to avoid damages. The set contains:

- Metal platform
- Left and right side reversible ceramic panels
- Rear panel support
- Rear fluted panel
- 5 driftwood logs
- 4 ceramic pebbles

**580RGL Reflective Glass Liner Set.** To install the 580RGL, see the installation instructions provided with the kit.

### Install liners

1. Remove the rear panel support inside the firebox (3 screws).
2. Replace with the rear panel support provided with the 530DWK kit and fix it (3 screws).

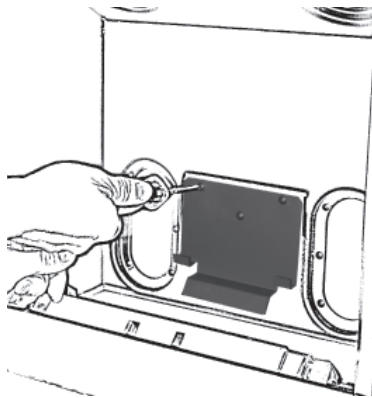

**If installing the 567FGP Top Grille (sold separately), fit it now.** See instructions supplied with the grille.

3. Place the rear panel on the rear support as indicated. Hold in place and go to next step.

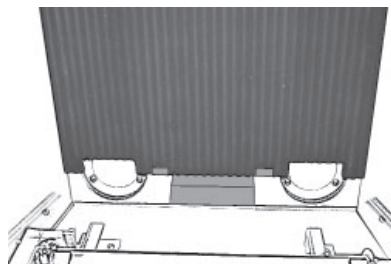

4. Place the left and then the right panels in the firebox showing the black fluted sides.

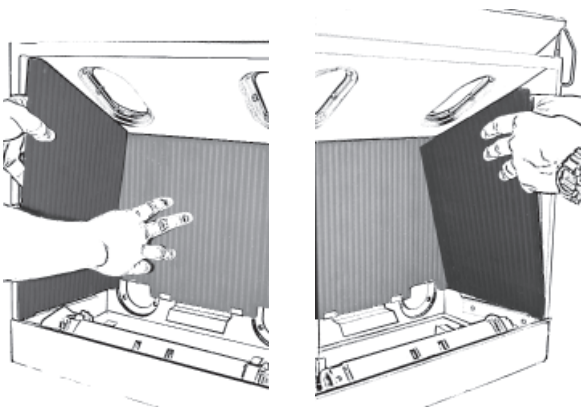

### Install platform, driftwood logs and rocks

1. Place the protrusion at the back of the base log on the ledge of the rear panel support as far back as it will go. Then pull the log evenly towards the front until it rests against the burner supports.

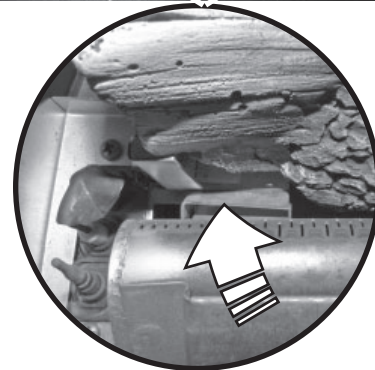
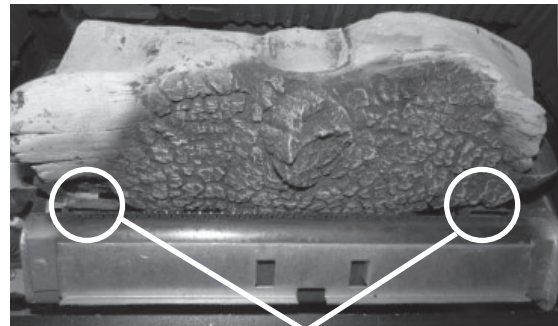
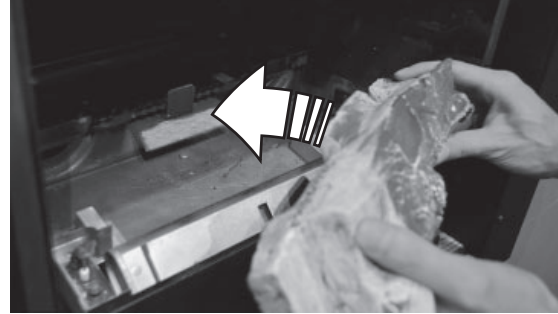

2. Place the metal platform and centre it over the burner and around the base log with the pegs on the top. The front of the platform must rest on the edge of the firebox. The right end rests of the base log.

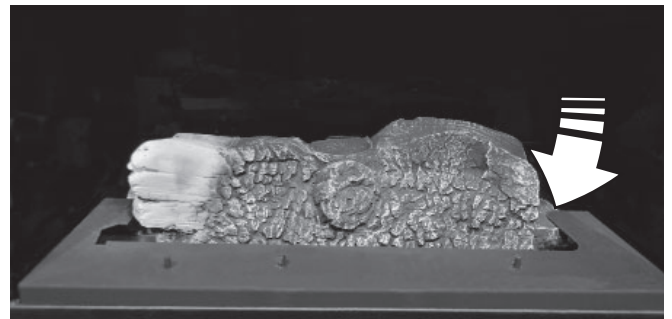

## Installation

- Place the rear log on top of the base log locating it into the notches on top of the base log.

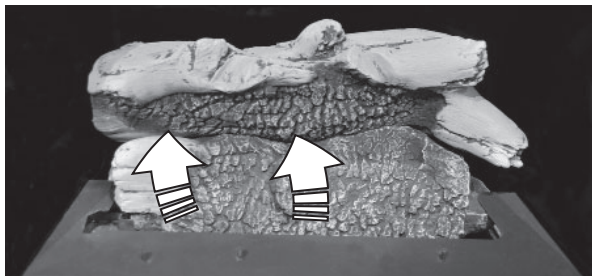

- Place the centre log on the platform inserting the peg into the hole on the log as indicated. Line up the log parallel to the platform.

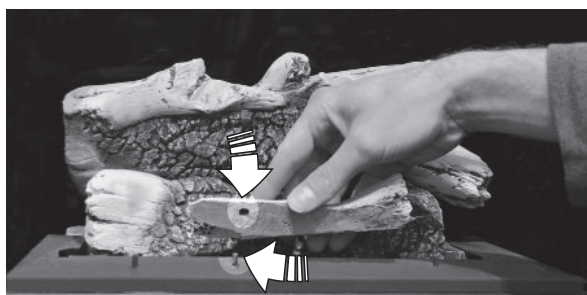

- Place the right log inserting the platform peg into the hole at the end of the log; rest the upper end of the log in the notch on the rear log as indicated.

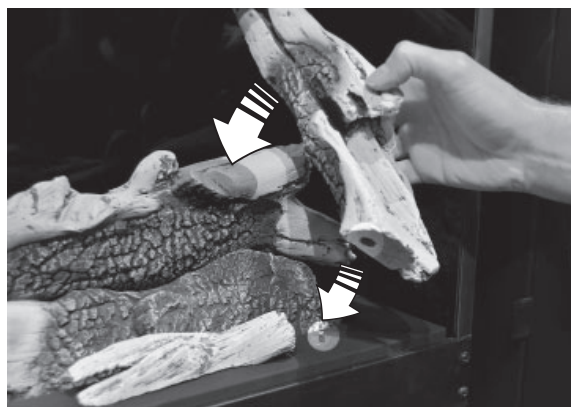

- Place the left log inserting the platform peg into the hole at the end of the log; rest the upper end of the log in the notch on the rear log as indicated.

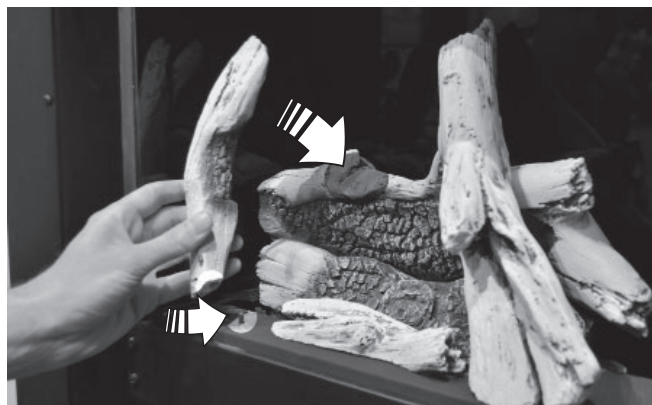

- Place one larger rock on each end of the platform to cover its edge as indicated; place the smaller rocks on the platform in front the larger rocks as indicated.



**Refit and Check Window**

1. Place the window centrally against the engine unit and resting on the support at bottom front of the engine.
2. Pull the clamping bars forward and rotate inwards to secure the top of the window.

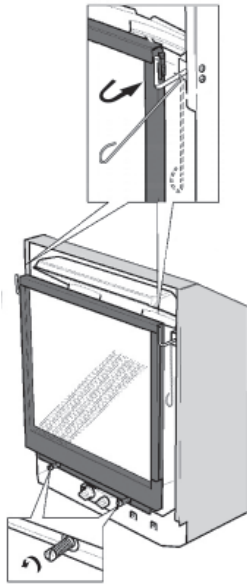

3. Fit the two spring loaded bolts through the bottom of the window and tighten to secure the bottom of the window.
4. Pull the top of the window forward and release to ensure the springs return it in position.
5. Similarly check the bottom of the window by pulling it forward and releasing.

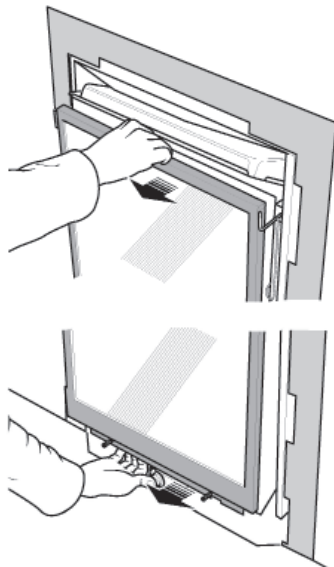

6. Apply firm hand pressure around the window frame to ensure the window is sealed tight against the firebox.

**! DANGER**

The window unit must be correctly installed, fastened and sealed after servicing or serious bodily injury and/or damage to the appliance may result.

To ensure a safe operation:

- Double-check that the bottom of the window frame is correctly bolted at the bottom;
- Verify that the levers are hooked properly to the window tabs then;
- Pull out the top and bottom of the window and release it to insure the springs return it;
- Ensure the window is sealed before operation.

**! WARNING**

Failure to install the window correctly can:

- Leak carbon monoxide.
- Affect the performance of the fireplace.
- Damage components.
- Cause overheating resulting in dangerous conditions.

Damage caused by incorrect window installation is not covered by the Valor warranty.

7. If the Hot Glass Warning plate has been removed from the front lower corner of the window, reinstall it by sliding it between the glass and the frame as indicated.

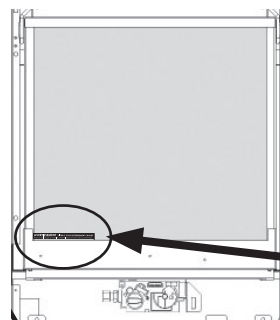

**! WARNING: EXTREMELY HOT GLASS AND FIREPLACE**  
Risk of severe burns. Keep Children away from fireplace & controls.  
**AVERTISSEMENT : VITRE ET FOYER EXTREMEMENT CHAUDS**  
Risque de brûlures graves. Tenir les enfants à l'écart du foyer et des commandes.

**Safety warning plate**

**! WARNING: EXTREMELY HOT GLASS AND FIREPLACE**  
Risk of severe burns. Keep Children away from fireplace & controls.



# Installation

## Install Battery Holder

The batteries that power the receiver and handset need to be installed prior to synchronization and use.

1. Take the receiver out from under the firebox.
2. The battery holder and cable are supplied with the appliance. Insert 4 x 1.5 V high quality alkaline batteries in the battery holder and 1 9V battery in the remote handset.



3. Connect the cable to the receiver.

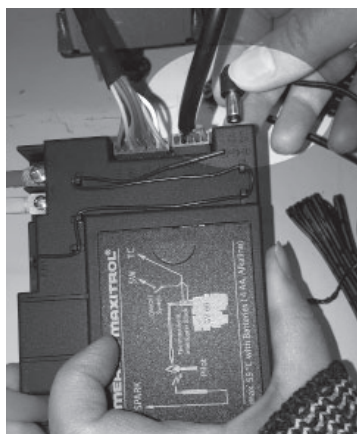

4. Connect the other end of the cable to the battery holder.

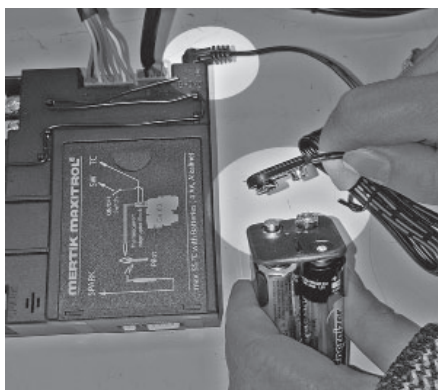

5. Place the receiver and battery holder as shown below (placement may vary with installed options).

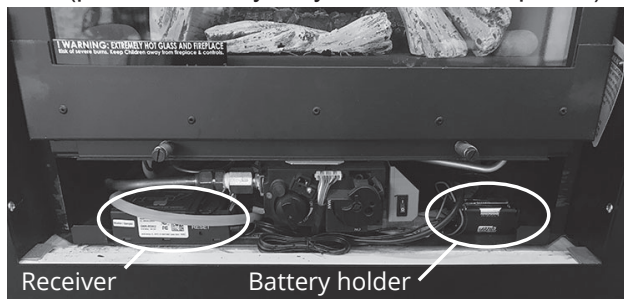

6. Use a heat resistant tie to gather any extra cable between the receiver and the holder.

### CAUTION

**DO NOT** let the cable touch the burner plate above, it will melt during operation.

## Synchronize Remote Control

The receiver and the handset of the remote control system must be initially synchronized before the first use.

1. With a thin object, press and hold the receiver's reset button until you hear one short and one long beep. Release the button after the second beep.



2. Within the subsequent 20 seconds, press the small flame button (🔥) on the remote handset until you hear two short beeps confirming the synchronization is set.

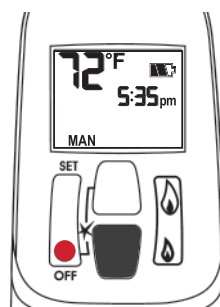

This is a one time setting only and is not required when changing the batteries in the remote handset. The remote control system is now ready to use.

## Check Operation

Turn the fireplace flame up and down using the remote control to confirm that the full range of inputs is achieved—see the remote control operation instructions starting on page 8.

## Set Aeration

Light the fire and allow the unit to warm up for 10–15 minutes to evaluate the flame picture. Burners are equipped with an adjustable shutter to control primary aeration. See the figures below. The shutter is factory-set to an aeration gap which will give optimum performance for the vast majority of installations.

### Air Shutter

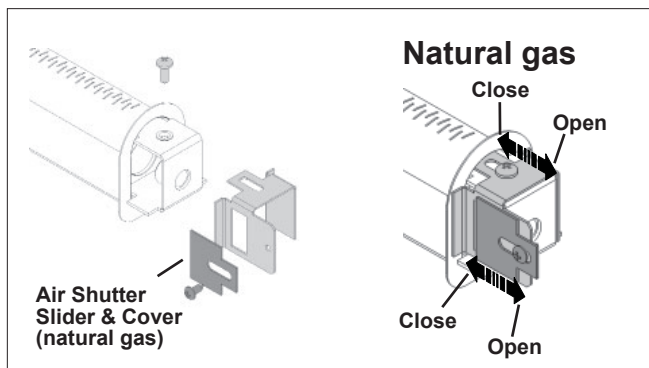

Depending of fuel bed used, altitude and other considerations, the flame picture may be improved by adjusting the aeration. The need for adjustment should be determined only by operating the appliance with the fuel bed and window installed and evaluating the flame picture after a 15-minute warm-up.

**Increasing aeration** will cause the flames to appear more transparent and blue showing more ceramic effects glow.

**Decreasing aeration** will cause the flames to appear more yellow or orange showing less ceramic effects glow.

**Too little aeration may result in black carbon forming and dropping into the firebox.**

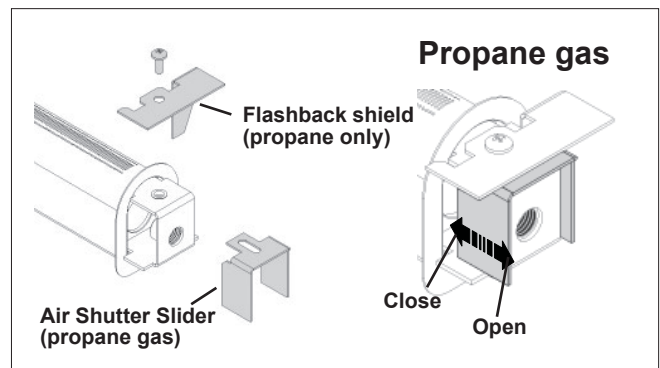

# Installation

## Install Front Trim and Barrier Screen

Install the front chosen by the customer for the fireplace. Install as well the barrier screen which is provided with the front trim.

Show the customer how to access the controls when the front is installed and how to remove the front.

Follow the instructions provided with the front and leave those instructions behind for the customer's further reference.

## Install Remote Control Handset Wall Holder

The remote control kit for this fireplace comes complete with a wall-mounted holder. This holder is not required in all installations but is provided as an optional feature for those customers who wish to mount the remote handset to the wall.

To install the holder to the wall, find a convenient location and use the hardware provided with the kit. See the diagram on the right for required hardware and configurations. Note that the holder can be installed at the base of a light switch plate.

**IMPORTANT.** The location of the remote control handset is important to assure proper temperature regulation. To obtain a constant temperature, we recommend that the handset should be between 3 and 15 feet away from the appliance **but not directly above it**. We also advise that the handset should be located away from any other heat source and not in direct sunlight as this may affect the temperature sensor located in the remote handset.

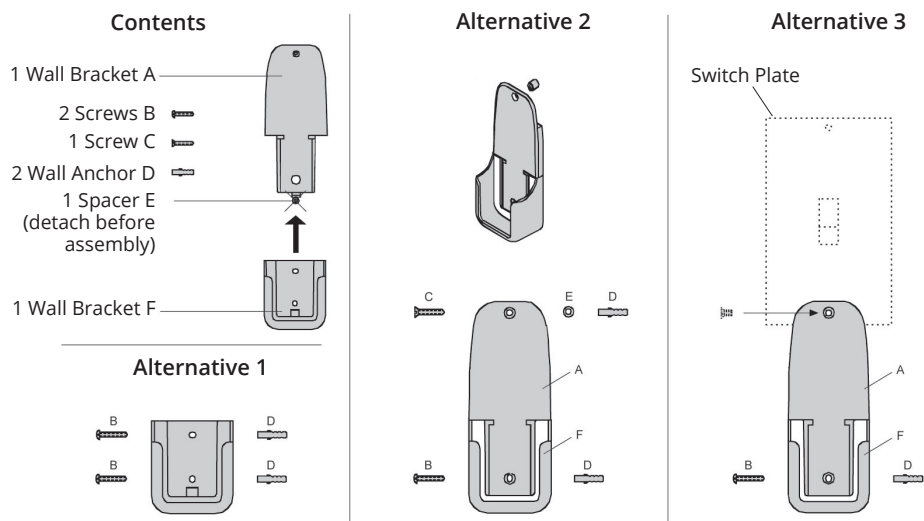

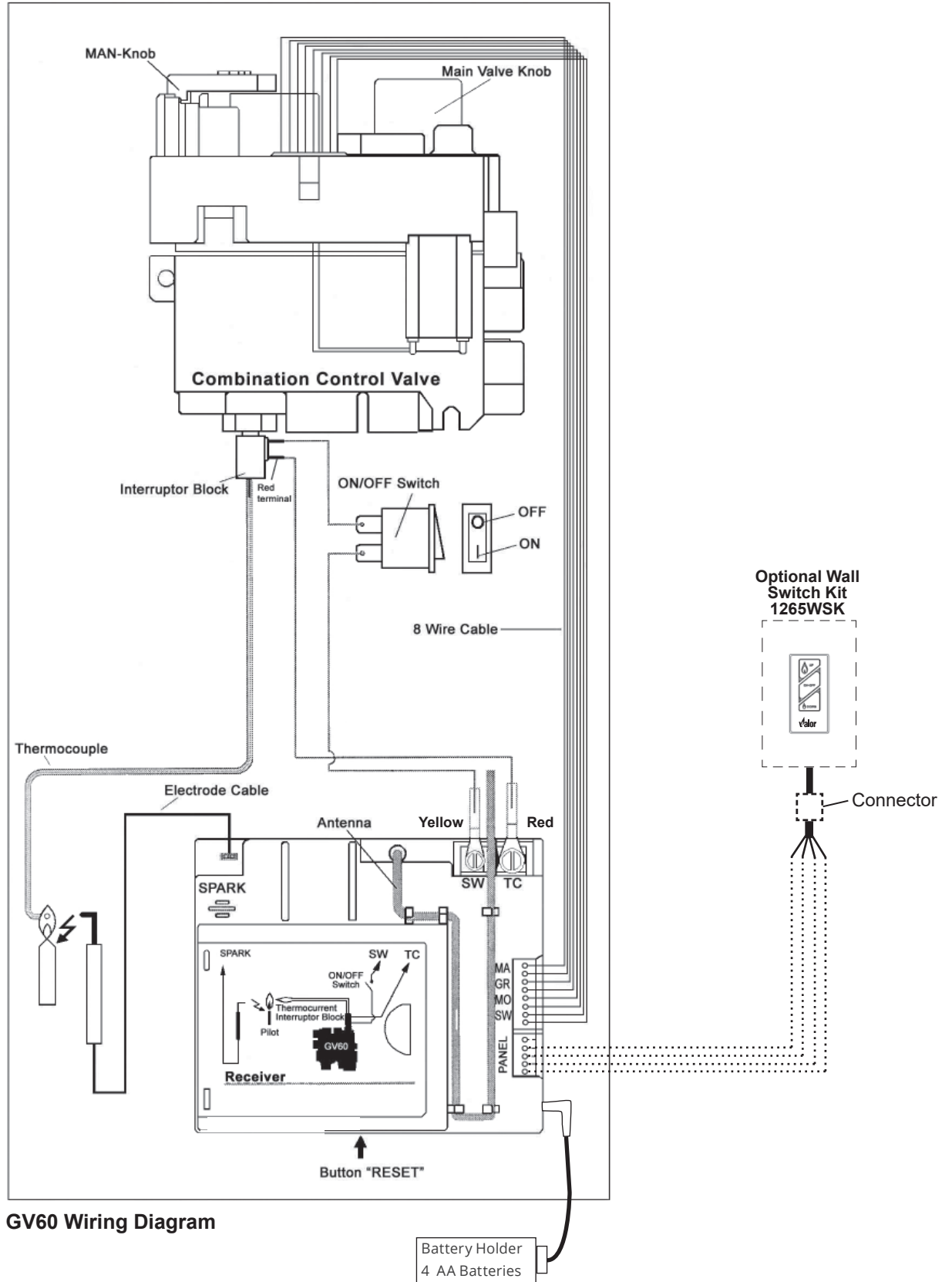

# Wiring Diagram



GV60 Wiring Diagram

# Approved Venting Components

**QUALIFIED  
INSTALLER**

<b>Approved Direct Vent Suppliers for Valor Models 530INI/IPI insert engine ONLY</b>										
 		<b>Venting Parts Code / availability by Manufacturer</b>								
		DURA-VENT	SELKIRK	ICC EXCEL DIRECT	SECURE VENT	RLH INDUSTRIES	AMERIVENT	MILES INDUSTRIES	BDM	
<b>Venting Parts Description</b>										
<b>Termination Caps</b>	<b>Vertical</b>	Standard Co-axial	46DVA-VC	4DT-VT	—	—	HSDV4658-1313	4DVC 4DH-1313	—	940264 940364 940206LP
		High Wind Co-axial	46DVA-VCH	—	TM-4SVT	SV4CGV	—	—	—	—
		Extended Co-axial	46DVA-VCE	—	—	—	—	—	—	—
	<b>Vertical</b>	Co-linear	—	—	TM-IVT	3PDVCV	HS-C33U-99	HCL-99-33 HCL-913-33	559CLT	940033B 940034B 940033HWS 940033RD
			—	—	—	—	HS-C33F-1313	HCL-1313-33		—
	<b>Horizontal</b>	Co-linear	—	—	—	—	—	—	720SWK <sup>3</sup>	—
<b>Vent Adapters / Couplers</b>	Universal Adapter 3" Flex Coupler	2150	—	TM-CFAA3	—	—	—	—	95090390	
	Co-linear Flex Connector	46DVA-ADF	—	—	—	—	—	—	—	
	Co-linear-to-Co-axial Adapter	46DVA-GK 46DVA-CLTA	—	TM-4CTA	—	—	4DCAT33	530CVA2	—	
	Co-axial Adapter 5 x 3 to 6-5/8 x 4	—	—	—	—	—	—	590FVK2 (incl. flashing)	—	
<b>Aluminum Flexible Liner</b>	3" or 4" diameter	NOTE: 2-ply liner approved to CAN/ULC S635 suitable for venting gas appliances. As manufactured by Z-Flex, Flexmaster and others.								
	Co-Linear	2280 Series	AF3-35L	TM-ALK33	—	—	—	—	952703	
				TM-ALT33	—	—	—	—	952704	
Co-Axial 5" x 3"	—	—	—	—	—	—	590FVK2	—		
<b>Flashings</b>	Roof Flashing 0/12-6/12	46DVA-F6	4DT-AF6	TF-4FA	SV4FA	—	4DF (0/12-5/12)	—	949606012	
	Roof Flashing 7/12-12/12	46DVA-F12	4DT-AF12	TF-4FB	SV4B	—	4DF12 (6/12-12/12)	—	949606712	
	Flat Roof Flashing	46DVA-FF	—	TF-4F	SV4F	—	—	—	949606001	
	Masonry Flashing	—	—	TF-4MF	—	—	—	559FSK	—	

- Notes:**
1. Follow instructions supplied with each manufacturer's components.
  2. Termination caps manufactured by RLH Industries or American Metal Products are from Homestyle Chimney Collection and can be ordered in one of the following finishes: a) aluminum; b) black powder coated; c) solid copper.
  3. The 720SWK Sidewall Kit can only be installed on the 530INI/IPI insert engines (logs, rocks and driftwood only).

## Warranty—Indoor Installations

If you have a problem with this unit, please contact your dealer or supplier immediately. Under no circumstances should you attempt to service the unit in any way by yourself. The warranties in paragraphs 1 and 2 are provided only to the initial user of this unit, are not transferable and are subject to the conditions and limitations in paragraphs 3, 4 and 5. Please review the conditions and limitations carefully and strictly follow their requirements.

### 1. Extended Warranty Coverage

For a period of up to ten (10) years, Miles Industries Ltd., (the "Company") or its appointed distributor will at its option pay the initial owner for the repair of, or will exchange the following parts or components which are found to be defective in material or workmanship under normal conditions of use and service:

Maximum Warranty Period		10 years
Part or Component	Defect Covered	
Exterior steel casing	Corrosion	✓
Glass	Loss of structural integrity	✓
Cast iron parts	Corrosion	✓
Firebox and heat exchanger	Corrosion (but not discoloration) causing loss of structural integrity	✓

### 2. Two-Year Parts Warranty

In addition, for two (2) years from the date of purchase, the Company, at its option, will repair or exchange all parts and components not listed above but that are found to have a bona fide defect in material or workmanship under normal conditions of use.

### 3. Conditions and Limitations

- The warranty registration card must be completed by the initial owner and returned to the company within 90 days. Alternatively, the warranty registration form may be filled out online at [www.valorfireplaces.com](http://www.valorfireplaces.com)
- Installation and maintenance must be performed by an authorized and trained dealer in accordance with the Company's installation instructions.
- This warranty is void where installation of the unit does not conform to all applicable codes including national and local gas appliance installation codes and building and fire codes.
- The owner must comply with all operating instructions.
- The Company is not responsible for the labor costs to remove defective parts or re-install repaired or replacement parts.
- The initial owner of the unit will be responsible for any shipping charges for replacement parts as well as travel time incurred by the dealer to perform the warranty work.

- This warranty applies to non-commercial use and service and is void if it is apparent that there is abuse, misuse, alteration, improper installation, accident or lack of maintenance to the unit.
- The warranty does not cover damage to the unit through:
  - Improper installation, operational or environmental conditions.
  - Inadequate ventilation in the area or competition for air from other household equipment or appliances.
  - Chemicals, dampness, condensation, or sulphur in the fuel supply lines which exceeds industry standards.
- This warranty does not cover glass, log breakage or damage to the unit while in transit.
- The Company does not allow anyone to extend, alter or modify this warranty and assumes no responsibility for direct, indirect or consequential damages caused by the unit. State or provincial laws where the initial user or user resides may provide specific rights extending this warranty and, if so, the Company's sole obligation under this warranty is to provide labor and/or materials in accordance with those laws.

### 4. Discharge of Liability

After two (2) years from the date of purchase, the Company may, at its option, fully discharge all obligations under this warranty by paying to the first owner the wholesale price of, or replacing, any defective parts.

### 5. No Other Warranty

All obligations to repair this unit are defined in this warranty. Some states or provinces may specifically mandate additional obligations on the part of manufacturers, but in the absence of such specific legislation, there is no other warranty or obligation expressed or implied.

# Warranty—Outdoor Installations

If you have a problem with this unit, please contact your dealer or supplier immediately. Under no circumstances should you attempt to service the unit in any way by yourself. The warranties in paragraphs 1 are provided only to the initial owner of this unit, are not transferable and are subject to the conditions and limitations in paragraphs 2 and 3. Please review the conditions and limitations carefully and strictly follow their requirements.

## 1. Two-Year Parts Warranty

Two (2) years from the date of purchase, the Company, at its option, will repair or exchange all parts and components that are found to have a bona fide defect in material or workmanship under normal conditions of use.

## 2. Conditions and Limitations

- a) The warranty registration card must be completed by the initial owner and returned to the company within 90 days. Alternatively, the warranty registration form may be filled out online at [valorfireplaces.com](http://valorfireplaces.com)
- b) Installation and maintenance must be performed by an authorized and trained dealer in accordance with the Company's installation instructions.
- c) This warranty is void where installation of the unit does not conform to all applicable codes, including national and local gas appliance installation codes and building and fire codes.
- d) The owner must comply with all operating instructions.
- e) The Company is not responsible for the labor costs to remove defective parts or re-install repaired or replacement parts.
- f) The initial owner of the unit will be responsible for any shipping charges for replacement parts as well as travel time incurred by the dealer to perform the warranty work.
- g) This warranty applies to non-commercial use and service and is void if it is apparent that there is abuse, misuse, alteration, improper installation, accident or lack of maintenance to the unit.
- h) This warranty does not cover damage to the unit due to:
  - i) Improper installation, operational or environmental conditions.
  - ii) Inadequate ventilation in the area or competition for air from other household equipment or appliances.
  - iii) Damage due to chemicals, dampness, condensation, or sulphur in the fuel supply lines which exceeds industry standards.
- i) This warranty does not cover glass, log breakage or damage to the unit while in transit.
- j) The Company does not allow anyone to extend, alter or modify this warranty and assumes no responsibility for direct, indirect or consequential damages caused by the unit. State or provincial laws where the initial owner or user resides may provide specific rights extending this warranty and, if so, the Company's sole obligation under this warranty is to provide labor and/or materials in accordance with those laws.

## 3. No Other Warranty

All obligations to repair this unit are defined in this warranty. Some states or provinces may specifically mandate additional obligations on the part of manufacturers, but in the absence of such specific legislation, there is no other warranty or obligation expressed or implied.

## Replacement Parts

	Description	Part no.		Description	Part no.
1	Side wall support (2)	330A898	36	Handset G6R H3T5-ZV (BJ)	4001910
2	Rear wall support	320B320	37	Wall mount holder	9000008
3	Velcro strip	4000022	38	Wiring harness	4001187
4	Port cover	4000828AH	39	Hot glass warning plate	4003093
5	Exhaust slide assembly	4005299	40	Ceramic coals & liners set	530CSK
6	Exhaust slide gasket	4001662	41	Ceramic coal set	000B245
7	Restrictor plates (2)	4002895	42	Centre left coal	640K615
8	Adjustable plates (2)	4002896	43	Base coal	650K237
9	Window unit	050A216	44	Centre right coal	640K616
10	Window screw assy (2)	000B214S	45	Front right coal	640K618
11	Burner unit incl. #22 (natural gas)	3000025	46	Front left coal	640K617
	Burner unit incl. #22 (propane gas)	740K185	47	Ceramic reversible walls set	4001160
12a	Aeration shutter slider (natural gas)	4002345	48	Rear reversible panel	4001161
	Aeration shutter cover (natural gas)	4002346	49	LH reversible panel	4001162
12b	Aeration shutter slider (propane gas)	320B293	50	RH reversible panel	4001163
	Flashback shield (propane gas)	3000371	51	Traditional logs & liners set	530LSK
13	Pilot unit complete (natural gas)	4000062	52	Traditional log set	4000162
	Pilot unit complete (propane gas)	4000063	53	Right middle log	4000372
14	Pilot injector (natural gas)	4002511	54	Right side front log	4000470
	Pilot injector (propane gas)	720A195	55	Front log	4000370
15	Thermocouple	4000061	56	Base log	4000368
16	Hooked olive for pilot	720A196	57	Left middle side log	4000371
17	Electrode	720A543	58	Rear log	4000369
18	Electrode nut	720A200	59	Ceramic reversible walls set	4001160
19	Olive nut for pilot	420K385	60	Rear reversible panel	4001161
20	Pilot shield	4000144	61	LH reversible panel	4001162
21	Pilot support bracket	330A904	62	RH reversible panel	4001163
22	Main burner pipe	030A225	63	Ceramic rocks & liners set	530RSK
23	Olive nut	220K567	64	Top far left rock	4001867
24	Olive	420K342	65	Top left rock	4001868
25	Base support bracket (2)	330A894	66	Top right rock	4001869
25a	Spacer angle (2)	4000355	67	Top far right rock	4001870
26	Elbow injector (natural gas)	720A580	68	Left rock	4001877
	Elbow injector (propane gas)	9730013	69	Right rock	4001878
27	Pilot pipe	030A226	70	Bottom left rock	4001874
28	Snap off olive nut	220K913	71	Bottom center rock	4001875
29	Window support	320B399	72	Bottom right rock	4001876
30	Switch bracket	4001070	73	Middle left rock	4001871
31a	Switch with cable	4001036	74	Middle center rock	4001872
31b	Cable interrupter/receiver	4001035	75	Middle right rock	4001873
32	Interrupter block	4001037	76	Rock base	4001880
33a	GV60 Valve (natural gas)	4003094	77	LH reversible wall	4001162
33b	GV60 Valve (propane gas)	4003107	78	Rear fluted wall	4001881
34	Ignition cable	4001039	79	RH reversible wall	4001163
34a	Ignition cable sleeve	4002244	80	Rear liner holder	4001882AH
35	Receiver G6R-R3AM-ZV (CP)	4001911	81	Ceramic platform	4001879



## Replacement Parts

	Description	Part no.
82	Driftwood Kit	530DWK
83	Log Set (including pebbles)	4005603
84	Base log	4005887
85	Rear log	4005888
86	Left log	4005889
87	Right log	4005890
88	Centre log	4005891
89	Brown beach pebble	4003082
90	Small grey beach pebble	4003086
91	Grey beach pebble	4003083
92	Small beige beach pebble	4003087
93	Metal platform	4006017AH
94	Rear liner panel fluted	4001881
95	Reversible LH brick/fluted panel	4001162
96	Reversible RH brick/fluted panel	4001163
97	Rear liner holder support	4001882AH
98	GV60 Repair Kit	4004544
99	Auxiliary battery holder	4006553
100	Battery holder cable 1500 mm	4006552
101	2.5-4.5" hose clamp (2)	4000768

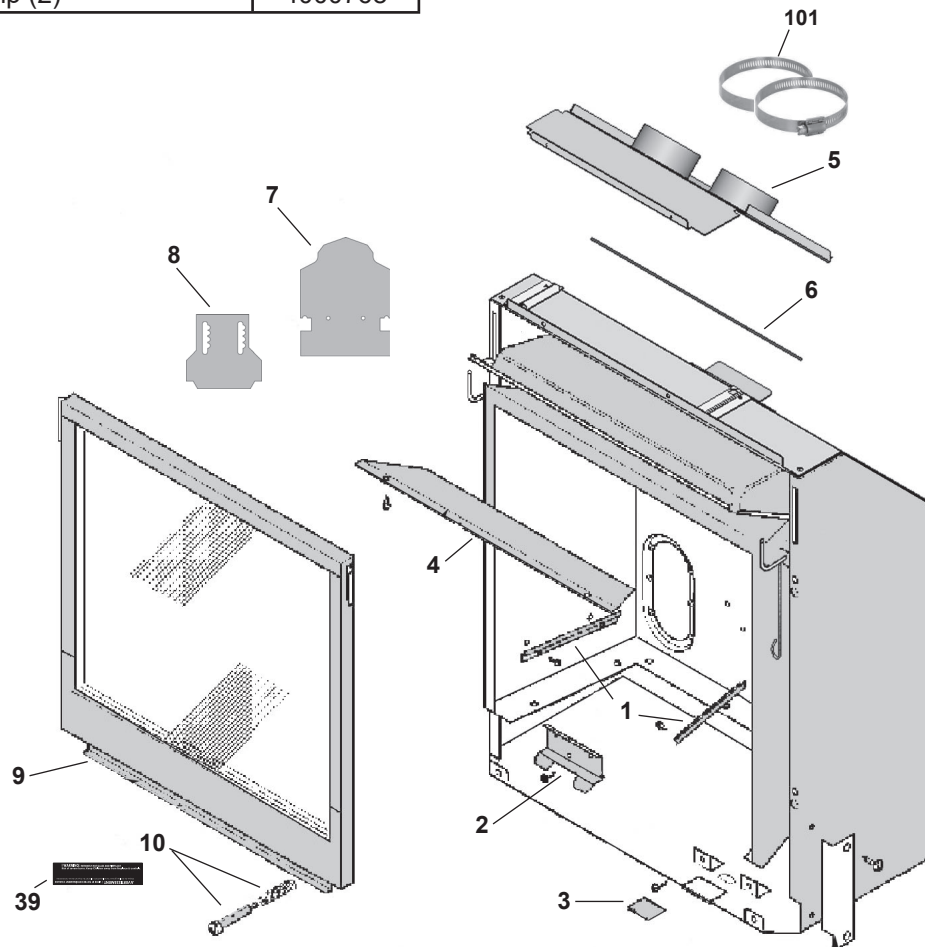

# Replacement Parts

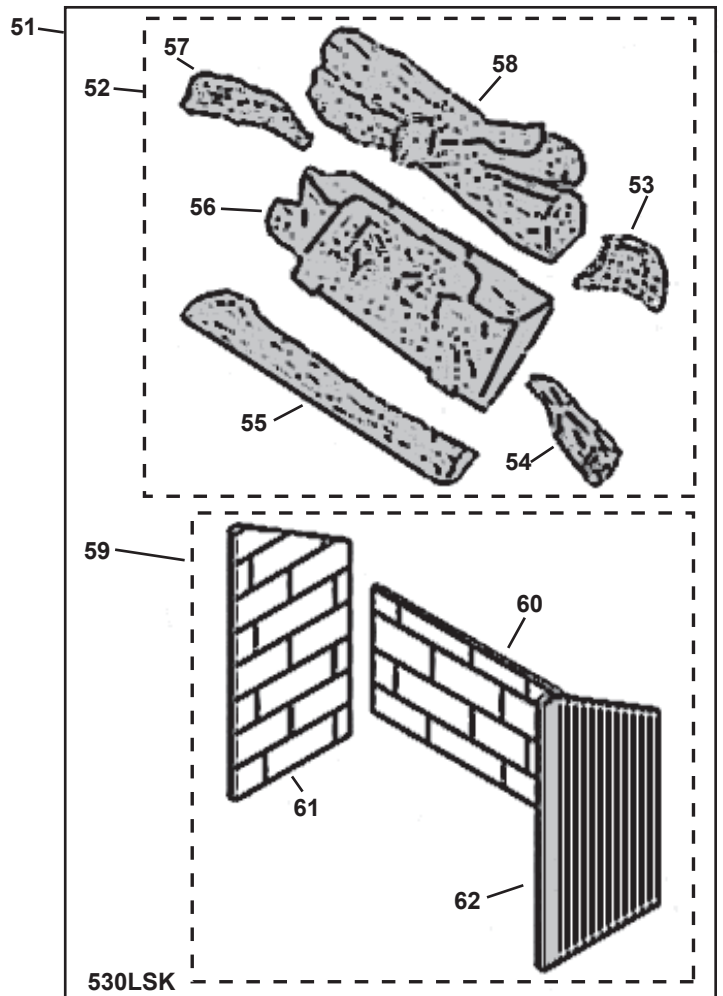
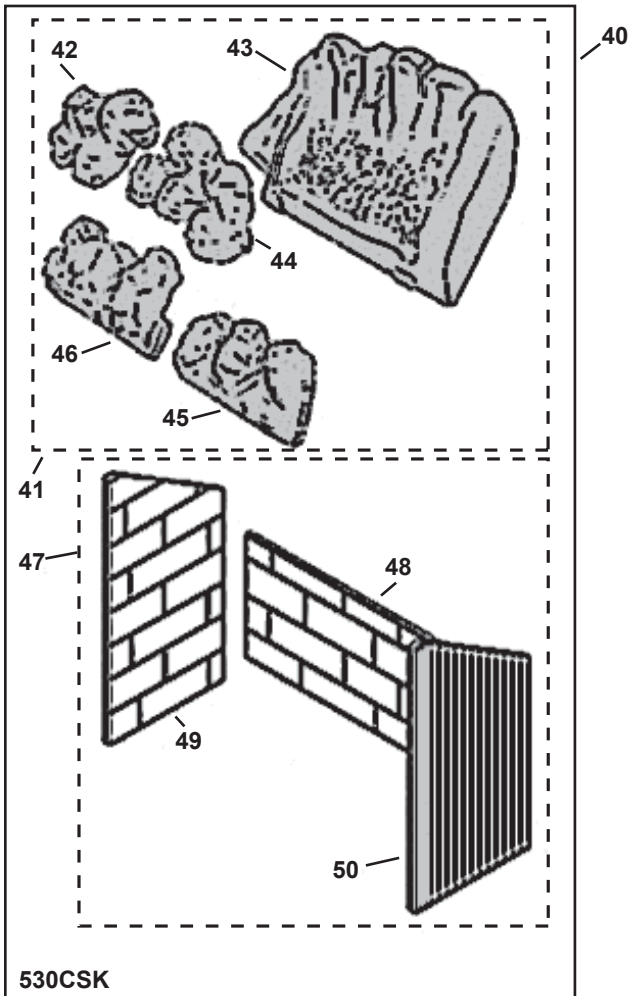
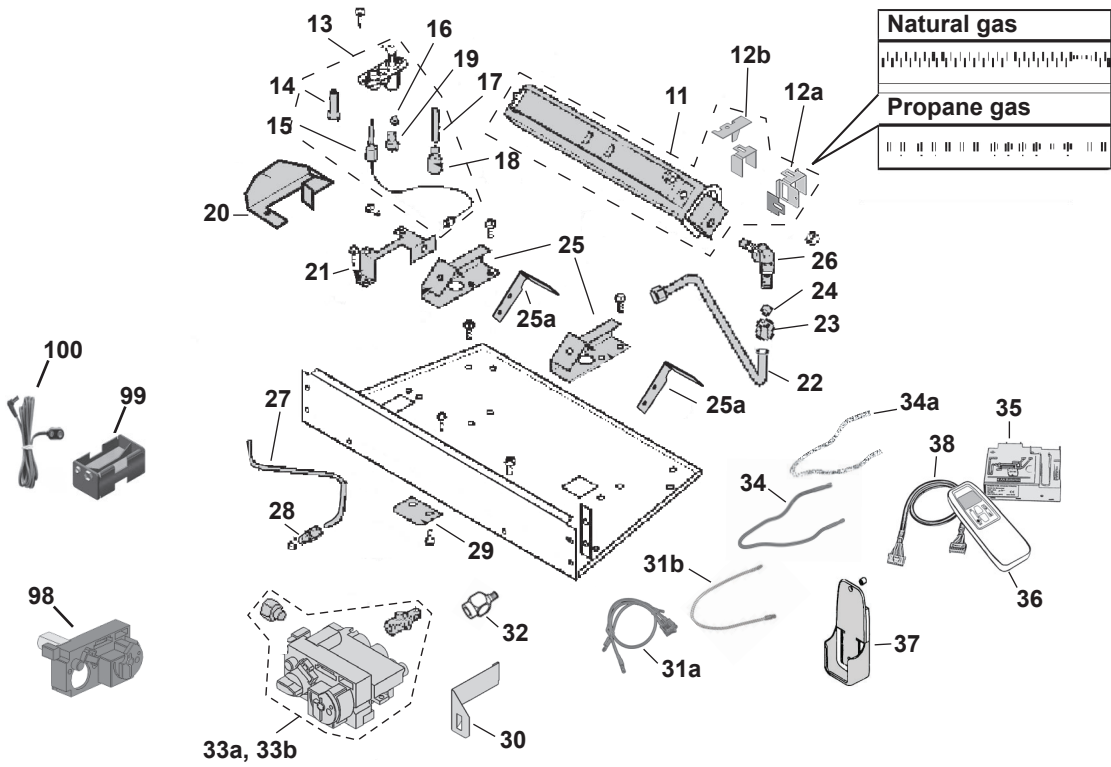

# Replacement Parts

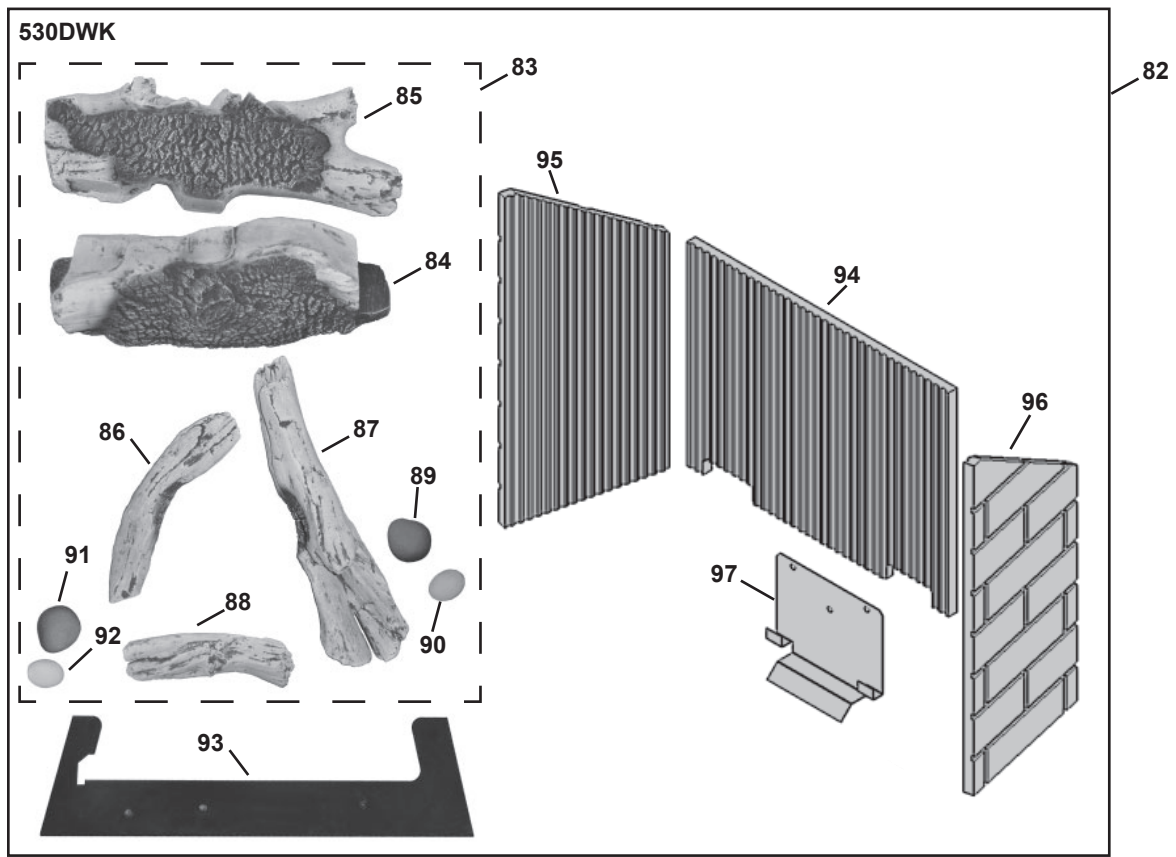
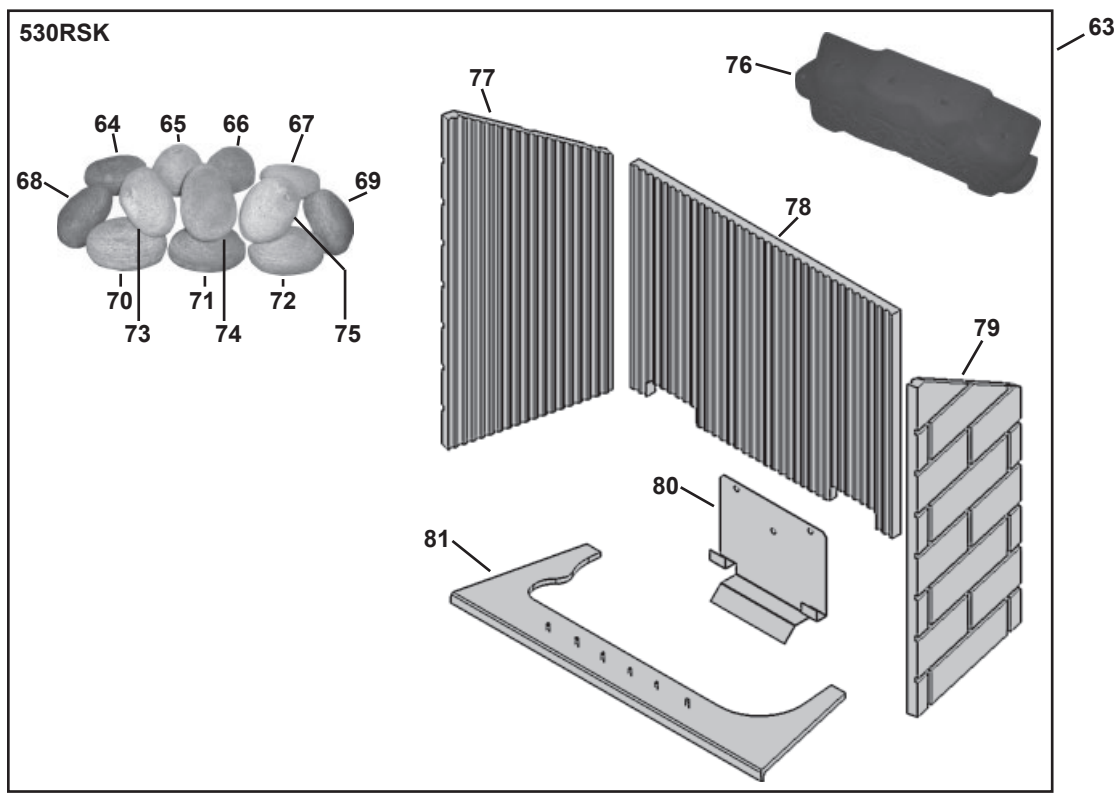



## Thank You ...

For purchasing a Valor by Miles Industries. Your new radiant gas heater is a technical appliance that must be installed by a qualified installer.

*Please fill in the information below. The information provided will be used for customer records only.*

### Fireplace Information

Model Number: 530  INI (natural) or  IPI (propane)  INSTALLED OUTDOOR

Serial Number:

Date Purchase (yyyy-mm-dd):

Dealer:

### Customer Information

First Name:

Last Name:

### Contact Information

Email:

### Mailing Address

Address:

City:

Province/State:

Postal/Zip Code:

Country:

Cut out page, fill information, and mail to Miles Industries Ltd.

Online Warranty registration at [www.valorfireplaces.com](http://www.valorfireplaces.com)



Tape Shut



Fold here



Postage  
needed

Valor Fireplaces  
190 - 2255 Dollarton Highway  
North Vancouver, BC V7H 3B1  
Canada

Online Warranty registration at [www.valorfireplaces.com](http://www.valorfireplaces.com)

*Thank you for choosing a Valor Product*