

INSTALLATION & OWNER'S MANUAL

valor® G3 Series



Gravity Vent Gas Insert Fireplace 738KN (natural gas) / 738KP (propane gas)

! DANGER

Please read this manual BEFORE installing and operating this appliance.



HOT GLASS WILL CAUSE BURNS.

DO NOT TOUCH GLASS UNTIL COOLED.

NEVER ALLOW CHILDREN TO TOUCH GLASS.

A barrier designed to reduce the risk of burns from the hot viewing glass is provided with this appliance and must be installed for the protection of children and other at-risk individuals.

INSTALLER: Leave this manual with the appliance.
CONSUMER: Retain this manual for future reference.

This manual contains instructions to install the **ENGINE ONLY**. A trim kit is **REQUIRED** to complete the installation. A barrier screen is provided with the trim kit. **Refer to the manual supplied with the trim for installation.**

⚠ WARNING

FIRE OR EXPLOSION HAZARD

Failure to follow safety warnings exactly could result in serious injury, death, or property damage.

- Do not store or use gasoline or other flammable vapors and liquids in the vicinity of this or any other appliance.
- **WHAT TO DO IF YOU SMELL GAS**
 - Do not try to light any appliance.
 - Do not touch any electrical switch; do not use any phone in your building.
 - Leave the building immediately.
 - Immediately call your gas supplier from a neighbor's phone. Follow the gas supplier's instructions.
 - If you cannot reach your gas supplier, call the fire department.
- Installation and service must be performed by a qualified installer, service agency or the gas supplier.

This appliance may be installed in an after-market permanently located, manufactured (mobile) home where not prohibited by local codes.

This appliance is only for use with the type of gas indicated on the rating plate. This appliance is not convertible for use with other gases, unless a certified kit is used.

This appliance is a domestic room-heating appliance. It must not be used for any other purposes such as drying clothes, etc.

This appliance is suitable for installation in a bedroom or bed sitting room.

Installer: Place model/serial number here.

Ce guide est disponible en français sur demande.

Table of Content

FOR THE OWNER

Safety and Your Fireplace	3
Introduction	6
Locating Fireplace & Lighting Information Card	6
Operating Your Fireplace for the First Time	6
Your Fireplace’s Vent Safety Switch	6
Operating Your Fireplace	7
Fireplace Control	7
How to Turn Your Fireplace ON	7
How to Turn Your Fireplace OFF (including pilot)	7
How to Ensure Your Fireplace Cannot Be Turned ON Inadvertently	7
Lighting Instructions Plate	8
Using the Remote Control	9
Kits & Accessories	13
Servicing & Maintenance	14
Servicing Your Fireplace	14
Annual Inspection	14
Cleaning Your Fireplace	15
Checking Pilot and Burner Flames	17
Replacing Batteries	18
Using Handset Wall Holder.....	18
Warranty—Indoor Installations	41
Warranty—Outdoor Installations	42

FOR THE QUALIFIED INSTALLER

Specifications	19
Overview	20
Dimensions	21
Cavity	21
Clearances	22
Venting	23
Existing Fireplace Preparation	24
Installation Planning	24
Installation	25
Unpack the appliance	25
Remove Window	25
Connect Vent	26
Connect Gas Supply.....	27
Adjust Fuel Bed Support (if necessary)	28
Install Liner Panels	28
Install 739LSK Traditional Logs	30
Install 739RSK Ceramic Rocks	32
Install 739DWK Driftwood Kit	34
Re-install and Check Window.....	36
Install Battery Holder	37
Synchronize Remote Control.....	38
Check Operation.....	38
Adjust Aeration (if necessary).....	38
Install Front, Trim and Barrier Screen.....	39
Install Handset Wall Holder	39
Wiring Diagram	40
Warranty—Indoor Installations	41
Warranty—Outdoor Installations	42
Spare Parts	43

The information contained in this installation manual is believed to be correct at the time of printing. Miles Industries Ltd. reserves the right to change or modify any information or specifications without notice. Miles Industries Ltd. grants no warranty, implied or stated, for the installation or maintenance of your heater, and assumes no responsibility for any consequential damage(s).

IMPORTANT—Register Your Warranty

Registration of your Valor is highly recommended, and can be completed by scanning the QR code on the serial number label placed on the front cover of this manual by the installer or by visiting valorfireplaces.com/warranty.

Completing your registration enables us to properly address any warranty or service-related concerns that you may have. This information is strictly for customer service and warranty purposes, and will never be shared with any third party.

Massachusetts: The piping and final gas connection must be performed by a licensed plumber or gas fitter in the State of Massachusetts.

Designed and Manufactured by / for Miles Industries Ltd.
190 – 2255 Dollarton Highway, North Vancouver, B.C., CANADA V7H 3B1
Tel. 604-984-3496 Fax 604-984-0246
www.valorfireplaces.com



We recommend a US Certified National Fireplace Institute (NFI) specialist install our gas hearth products.



SAFETY AND YOUR FIREPLACE

Read and understand all instructions carefully before starting the installation. **Failure to follow** these installation instructions may result in possible fire hazard and will void the warranty.

Prior to the first firing of the fireplace, read the Owner's information section of this manual.

Do not use this appliance if any part has been under water. Immediately, call a qualified service technician to inspect the unit and to replace any part of the control system and any gas control that has been under water.

This unit is not for use with solid fuel.

Installation and repair should be performed by a qualified service person. The appliance and venting system should be **inspected** before initial use and at least annually by a professional service person. More frequent cleaning may be required due to excessive lint from carpeting, bedding, etc. It is **imperative** that the unit's control compartment, burner, and circulating air passageways **be kept clean** to provide for adequate combustion and ventilation air.

Always keep the appliance clear and free from combustible materials, gasoline, and other flammable vapors and liquids.

Never obstruct the flow of combustion and ventilation air. Keep the front of the appliance **clear** of all obstacles and materials for servicing and proper operation.

This unit must be used with a vent system as described in this installation manual. **No other vent system or components may be used.**

This gas fireplace and vent assembly must be vented directly to the outside and must never be attached to a chimney serving a separate solid fuel burning appliance. Each gas appliance must use a separate vent system. Common vent systems are prohibited.

Inspect the external vent cap on a regular basis to make sure that no debris, plants, trees, shrubs are interfering with the air flow.

Turn off the gas before servicing this appliance. It is recommended that a qualified service technician perform an appliance check-up at the beginning of each heating season.



WARNING:

This product can potentially expose you to chemicals including Benzene which are known to the State of California to cause cancer and birth defects or other reproductive harm. **For more information go to www.P65Warnings.ca.gov**

Do not use this heater as a temporary source of heat during construction.

Due to the high temperature, the appliance should be **located** out of traffic areas and away from furniture and draperies.

Clothing or flammable material **should not be placed** on or near the appliance.

This appliance is a **domestic room-heating appliance**. It must not be used for any other purposes such as drying clothes, etc.

Do not place furniture or any other combustible household objects within 36" of the fireplace front.

Be careful not to put any decorating objects sensitive to heat to close above or around the fireplace as it gets very hot when operating.

The glass door assembly must be in place and sealed before the unit can be placed into safe operation.

Do not operate this appliance with the glass door removed, cracked, or broken. Replacement of the glass door should be performed by a licensed or qualified service person. Do not strike or slam the glass door.

The glass door assembly shall only be replaced as a complete unit, as supplied by the fireplace manufacturer. No substitute material may be used.

Do not use abrasive cleaners on the glass door assembly. Do not attempt to clean the glass door when it is hot.

A barrier designed to reduce the risk of burns from the hot viewing glass is provided with this appliance and **shall be installed for the protection of children and other at-risk individuals.**

If the barrier becomes damaged, the barrier shall be replaced with the manufacturer's barrier for this appliance.

Any safety screen, guard or barrier removed for servicing the appliance, must be replaced prior to operating the appliance.

Children and adults should be alerted to the hazards of high surface temperature and should stay away to avoid burns or clothing ignition.

Young children should be carefully supervised when they are in the same room as the appliance. Toddlers, young children and others may be susceptible to accidental contact burns. A physical barrier is recommended if there are at-risk individuals in the house. To restrict access to a fireplace or stove, install an adjustable safety gate to keep toddlers, young children and other at-risk individuals out of the room and away from hot surfaces.



Safety and Your Fireplace

Read and carefully follow all safety warnings and operating instructions contained in your owner's manual

Replacement manuals are available by contacting the Valor Service Department at 1-800-468-2567 or visit www.valorfireplaces.com.

FOLLOW THESE IMPORTANT CHILD SAFETY PRECAUTIONS AND RECOMMENDATIONS

Parts of your Valor Fireplace become extremely hot while in operation.

The glass viewing window temperature can exceed 500 F at full capacity.

Momentary contact with a hot glass surface can cause a severe burn, even if the fireplace is operating at reduced heating capacity.

The glass window will remain hot for an extended period of time after the fireplace has been turned off. Ensure that children are prevented from touching the fireplace during the cool down period.

Toddlers and Young Children must be closely supervised at all times when they are in the same room as the operating fireplace. They lack full awareness of danger and rely on your protection. Toddlers, in particular, do not have the motor skills and response reflexes to withdraw in the event of accidental contact with a hot surface.

A physical barrier is strongly recommended if there are young children, or at-risk individuals in the house. Install an approved after-market safety gate to keep toddlers, young children and



other at-risk individuals a safe distance from the fireplace.

Keep the remote control handset out of reach of children at all times. A wall mount storage holster is provided with your remote control handset.

Ensure that the fireplace, including the pilot light, is completely turned off when children are present and close supervision and safety barriers are not available—see page 7 of this manual.

If the fireplace is not going to be used for the summer or any extended period of time, remove the batteries from the remote control handset and remote battery box. It is recommended that batteries are replaced annually in any event—see page 18.



SAFETY AND YOUR FIREPLACE

This manual and particularly the preceding and following pages contain very important information regarding the safe operation of your fireplace as well as maintenance instructions. Read carefully before operating your fireplace and pay special attention to the safety warnings.

A heating gas appliance does require safe handling. For this reason, we very strongly recommend children are not allowed to touch the fireplace or controls. **Install a screen or barrier in front of the fireplace to protect your children against severe burns.**

This appliance is designed and approved as a supplemental heater and provides the potential for most energy conservation when used while attended. The use of an alternate primary heat source is advisable.



WARNING EXTREMELY HOT!!!

- **Read the safety information starting on page 3 of this manual before operating your gas heater.**
- Some parts of your fireplace are **extremely hot**, particularly the **glass** window.
- **Do not let children touch the glass** or any parts of your fireplace **even after it is turned off** as it is still hot.
- **Use the barrier screen** provided with the trim or a gate to reduce the risk of severe burns.
- Keep the remote control handset **out of reach of children.**
- **Hot hearth/floor surface!** The hearth or floor directly in front of the fireplace is very hot when the fireplace heats. Even if constructed of non-combustible materials, and although safe, it may reach temperatures **in excess of 200° F** depending on choice of materials.
Do not step on it!
- Some materials or items, although safe, may discolor, shrink, warp, crack, peel, and so on because of the heat produced by the fireplace. **Avoid placing** candles, paintings, photos, and other items **sensitive to heat** within 36 inches (0.9 m) around the fireplace.
- Solid wood flooring in front of the fireplace (if allowed) may shrink during the heating season due to heat.

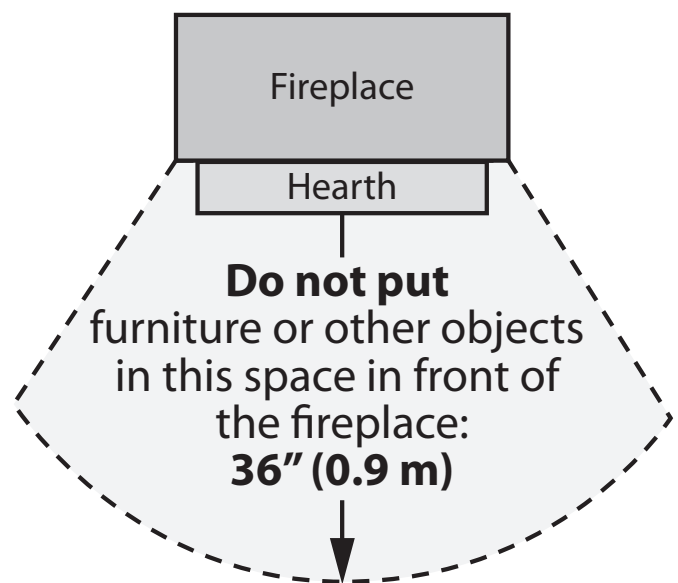

Thank You ...

For purchasing a Valor by Miles Industries. Your new radiant gas heater is a technical appliance that must be installed by a qualified dealer. Each Valor fireplace is fully tested during the production process for your safety and comfort.

Your unit has been professionally installed by:

Dealer Name: _____

Phone Number : _____

Should you encounter an operational problem, call your dealer immediately.

Do not try to repair the unit as you may cause an injury or damage the fireplace.

Locating Fireplace & Lighting Information Card

⚠ WARNING

DO NOT ATTEMPT TO TOUCH THE DATA CARD WHILE THE FIREPLACE IS STILL HOT! Let the fireplace cool first before touching it.

The Fireplace and Lighting Information card is located under the firebox.

To access the plate, remove the access panel, grab the card and slide it out to read it. There is important information on both sides of the card.

Fireplace model

Serial number

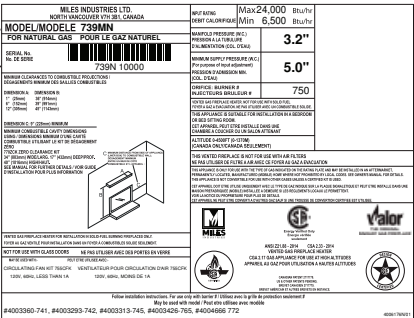

MILES INDUSTRIES LTD MILES INDUSTRIES INC. 2011 CANADA		MAXIMUM BTU Max 24,000 Min 6,500
MODEL/MODELE 739M3N FOR NATURAL GAS / POUR LE GAZ NATUREL		HEIGHT / HAUTEUR 3.2"
SERIAL No. / NO. DE SÉRIE 739N 10000		WIDTH / LARGEUR 5.0"
MILES CANADA'S COMMITMENT TO QUALITY MILES INDUSTRIES LTD. 2011 CANADA		DEPTH / PROFondeUR 7.50"
MILES INDUSTRIES LTD. 2011 CANADA		VALOR VALOR

Operating Your Fireplace for the First Time

When operating your new fireplace for the first time, some vapors may be released due to the burning of curing compounds used in the manufacture of the appliance. They may cause a slight odor and could cause the flames to be the full height of the firebox, or even slightly higher, for the first few hours of operation.

It is also possible that these vapors could set off any smoke detection alarms in the immediate vicinity.

These vapors are quite normal on new appliances. We recommend opening a window to vent the room. After a few hours use, the vapors will have disappeared and the flames will be at their normal height.

Flame Supervision Device

For your safety, this appliance is fitted with a flame supervision device which will shut-off the gas supply if, for any reason, the pilot flame goes out. This device incorporates a fixed probe, which senses the heat from the pilot flame. If the probe is cool, the device will prevent any gas flow unless manually lighting the pilot. See full lighting instructions on page 8 of this manual.

Performance of propane gas appliances may be affected by the quality of commercial gas supplied in your area.

Your Fireplace's Vent Safety Switch

This appliance is equipped with a vent safety switch which, when activated, will turn off the burner and pilot if the vent is blocked, disconnected, or if there is excessive down draught.

If the safety switch is activated, wait for it to cool off before trying to light the appliance again. The safety switch will cool off and reset itself automatically after 25 to 30 minutes.

In the event that the safety switch is activated again, contact a qualified service technician for inspection.

Should the safety switch require replacement, only use parts supplied by Miles Industries.

Operating Your Fireplace

Fireplace Control

Your fireplace can be controlled by the Thermostatic Remote Control which can be programmed to function automatically—see details starting on page 9.



Remote Control

How to Turn Your Fireplace ON

Press and hold button(s) until a short beep confirms the start sequence has begun; release buttons.

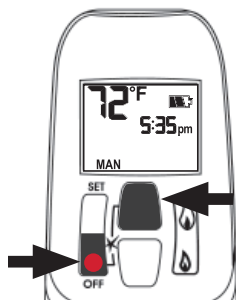

Remote control handset

Continuing beeps confirm the ignition is in process. When the pilot is lit, the gas flows—see section *Using the Remote Control* for more information.

How to Turn Your Fireplace OFF (including pilot)

Press and hold the OFF button for a second.

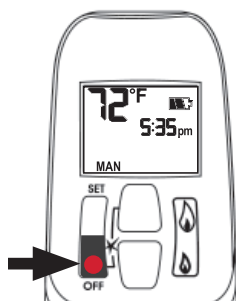

Remote control handset

If the flames are on, they go down and you hear the valve motor wind down. You hear a clunk and a beep indicating that the valve has received the signal from the remote control.

In the unlikely event that you cannot turn off your fireplace with the remote control handset, wait 6 hours and the fireplace will automatically go to pilot. You can then access the controls inside your fireplace.

Alternately, turn off gas supply. In all cases, call your dealer for service assistance.



How to Ensure Your Fireplace Cannot Be Turned ON Inadvertently

⚠ WARNING

RISKS OF SEVERE BURNS! SURFACES OF THE FIREPLACE ARE VERY HOT DURING OPERATION! Be very careful and wear gloves to access controls.

You can use one of the two following methods to ensure that your fireplace will not turn on when you don't want it on.

- On the gas valve, turn dial from ON position to MAN position as shown. Turning the dial to MAN will ensure that main burner cannot come on. The pilot will remain ON if lit.

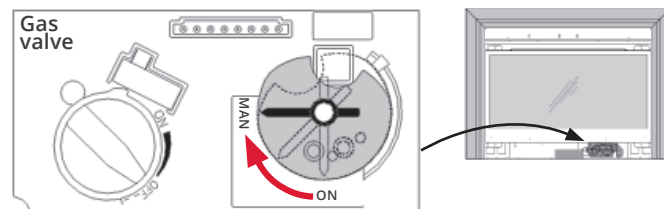

- Alternately, you can remove all batteries from the battery holder as well as the battery from the handset.

Automatic Shut-Off (in certain conditions)

Your fireplace's remote control is equipped with an automatic shut-off mechanism which is activated in certain conditions. See page 12 in the section *Using the Remote Control* for a description of this feature.

Operating Your Fireplace

Lighting Instructions Plate

The Lighting Instructions are located on a card attached to your fireplace. See *Locating Fireplace & Lighting Information Card* on page 6.

FOR YOUR SAFETY, READ BEFORE LIGHTING

WARNING: If you do not follow these instructions exactly, a fire or explosion may result causing property damage, personal injury or loss of life.

- A. This appliance has a pilot which must be lighted by hand or by remote control. Follow these instructions exactly. To save gas, turn the pilot off when not using the appliance for a prolonged period of time.
 - B. BEFORE LIGHTING, smell all around the appliance area for gas. Be sure to smell next to the floor because some gas are heavier than air and will settle on the floor.
- WHAT TO DO IF YOU SMELL GAS**
- Do not try to light any appliance.
 - Do not touch any electric switch; do not use any phone in your building.
 - Immediately call your gas supplier from a neighbor's phone. Follow the gas supplier's instructions.
 - If you cannot reach your gas supplier, call the fire department.
- C. Use only your hand to push in or turn the control knobs. Never use tools. If the knobs will not push in or turn by hand, don't try to repair them; call a qualified service technician. Force or attempted repair may result in a fire or explosion.
 - D. Do not use this appliance if any part has been under water. Immediately call a qualified service technician to inspect the appliance and to replace any part of the control system and any gas control, which has been under water.

LIGHTING INSTRUCTIONS

1. STOP! Read the safety information above.
2. TO CLEAR ANY GAS, turn main valve off by pressing OFF (red dot) button on remote handset (1).
 - Wait five (5) minutes to clear out any gas, then smell for gas, including near the floor. If you smell gas, STOP! Follow "B" in the safety information above on this label. If you don't smell gas, go to the next step.
3. AUTOMATIC IGNITION: MAN-knob (2) in ON position. Ensure Flame Adjustment knob (3) is set to lowest setting (☺) (Fig. 1). Locate the pilot (Fig. 3.) inside of firebox.
 - ON/OFF wall switch (1) in ON position,
 - On the remote control handset, press the OFF button (red dot) and large flame button (🔥) simultaneously; a short acoustic signal confirms the start has begun.
 - Further short acoustic signals indicate the ignition process is in progress.
 - When the pilot is lit, the Flame Adjustment knob (3) will automatically rotate to the highest setting
 - Press the small flame button (🔥) on the remote control handset to reduce the flame height
4. MANUAL IGNITION: MAN-knob (2) in MAN position (Fig. 2). With the window off, locate the pilot (fig. 3) inside of the firebox.
 - Set Flame Adjustment knob (3) to the lowest setting (☺).
 - Push down the metallic core (4) with a pen or similar instrument; this will establish the pilot gas flow.
 - Light gas at the pilot (5) with a match.
 - Continue holding down metal core (4) for about 10 seconds; after release, pilot should remain lit.
 - If the pilot will not stay lit after several tries, turn the gas control knob (3) to OFF (☹) and call your local service technician or gas supplier.
 - Reinstall the window and set the MAN-knob (2) to ON; turn Flame Adjustment knob (3) up (☺) or down (☹) manually or use the flame buttons (🔥) (🔥) buttons on the remote control handset to adjust the flame height.

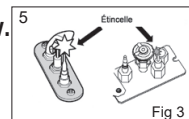
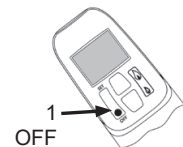
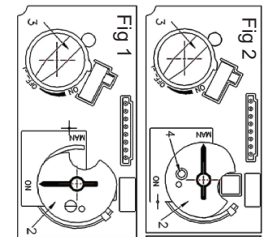

TO TURN OFF GAS TO APPLIANCE

1. AUTOMATIC SHUT-OFF (using the remote control handset):
 - Press and hold the 🔥 (small flame) on the remote control handset to shut-off the main burner gas flow;
 - Press "OFF" button (red dot) on remote handset to shut-off the appliance, including pilot flame.

Using the Remote Control

Radio Frequency

315 MHz for USA and Canada.

This device complies with Part 15 of the FCC Rules and with Industry Canada license-exempt RSS standard(s). Operation is subject to the following two conditions:

- (1) this device may not cause harmful interference, and
- (2) this device must accept any interference received, including interference that may cause undesired operation.

NOTE: Before using the remote control system for the first time, the receiver and the handset must be synchronized. See the section *Synchronize Remote Control on page 1*.

IMPORTANT: BEFORE YOU BEGIN, please note that on this system, the settings of time, temperature and automatic ON/OFF **can only be programmed when the function display is flashing**. Be patient when programming as it can take a few seconds to set.

Note: In the TEMP or TIMER modes, the remote handset senses the room temperature and adjusts the flame accordingly.

To communicate, the handset should be within 15 feet (4.5 meters) of the fireplace.

Do not leave the handset on the mantel or hearth.

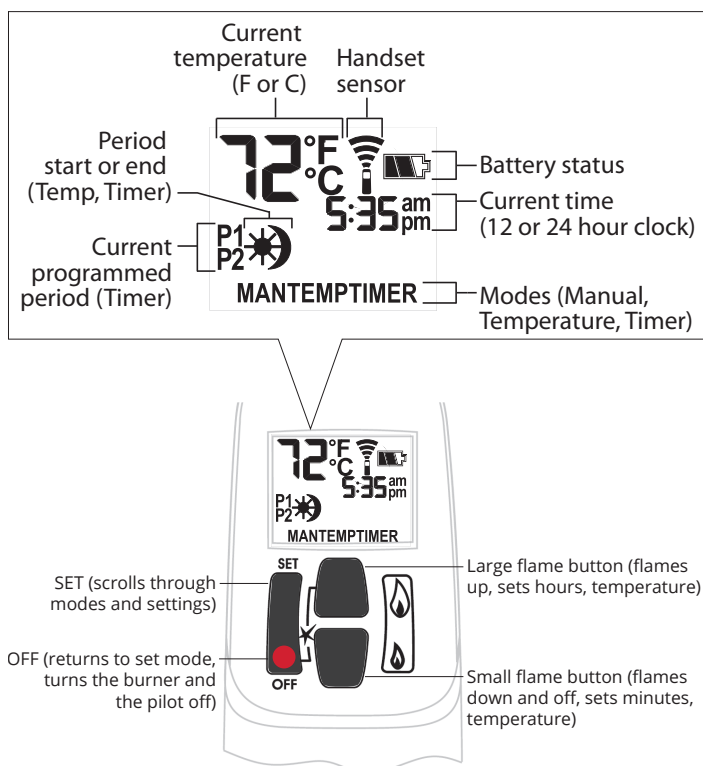

Turn Fireplace ON

Press ● + 🔥 buttons until you hear a short beep; release buttons.

Beeping continues until pilot is lit.

Burner lights to maximum flame height and handset goes automatically to manual (MAN) mode.

NOTES:

On the valve, MAN button must be at ON, in full counter-clockwise position .

ON/OFF switch (if equipped) must be in I (ON) position.

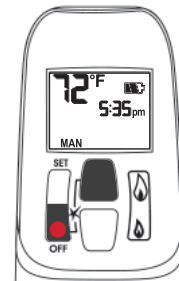

Turn Fireplace OFF

Press ● button.

When pilot is just turned off, wait 2 minutes to light it again.

Standby Mode (Pilot Flame)

Press and hold 🔥 to set fireplace to pilot.

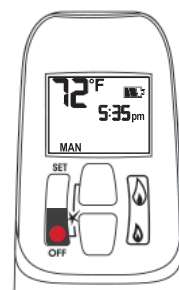

Adjust Flames Height

With pilot lit, press and hold buttons:

🔥 = increase flame height

🔥 = decrease flame height or set to pilot

For fine adjustment, tap buttons.

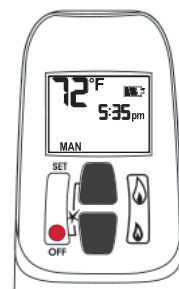

Express Low and High Fire

Double-click buttons:

🔥 = increase flame to maximum height "HI"

🔥 = decrease flame minimum height "LO"

NOTE: Flame goes to high fire first before going to designated low fire.

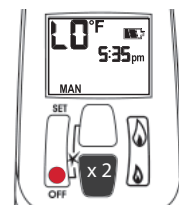
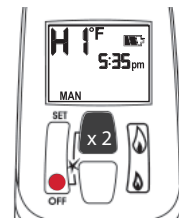

Using the Remote Control

Setting °C/24-hr or °F/12-hr clock

In MAN mode, press and hold ● + 🔥 buttons until temperature / clock display changes from

°F / 12-hour ↔ °C / 24-hour

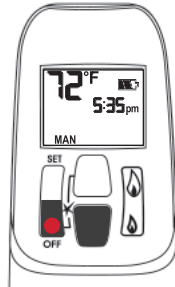

Setting Time

The time display will flash after either:

- installing the battery, or
- pressing 🔥 + 🔥

To set the time, press buttons:

🔥 = hour

🔥 = minutes

Press ● or wait to go back to MAN.

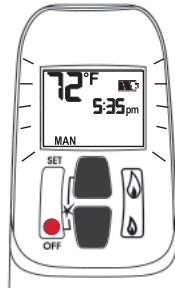

Modes of Operation

Briefly pressing SET cycles through modes of operation.

MAN > ⚡TEMP > 🌙TEMP > TIMER > MAN

NOTE: Press 🔥 or 🔥 to reach MAN mode.

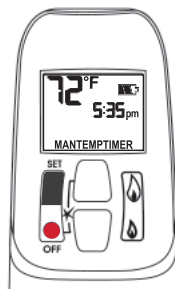

MAN Manual Mode

Manual flame height adjustment.



⚡TEMP Daytime Temperature Mode

When pilot is lit, room temperature is measured and compared to set temperature. Flame height automatically adjusts to reach Daytime Set Temperature.



🌙TEMP Night time Setback Temperature Mode

When pilot is lit, room temperature is measured and compared to set temperature. Flame height automatically adjusts to reach Night Time Setback Temperature.

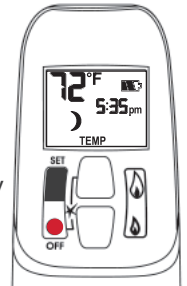

TIMER Timer Mode

When pilot is lit, two periods of time (P1 and P2) can be programmed to use Daytime and Night time temperatures at specific times.

Note: Display shows set temperature every 30 seconds.

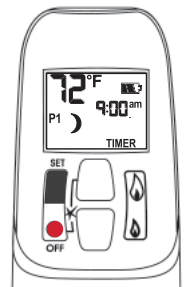

Set the different parameters when they are flashing.

Using the Remote Control

Setting high / low Temperatures

Setting "DAYTIME" high temperature.

Default Settings:  TEMP 23 °C/74 °F

Press SET to scroll to  TEMP

Hold SET button until TEMP flashes.

To set  Daytime Temperature:

 = increases temperature.

 = decreases temperature.

Press  or wait to complete setting.

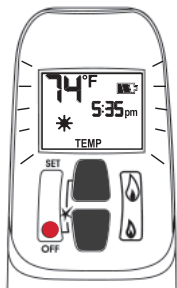

Setting "NIGHT TIME SETBACK" low temperature.

Default Settings:  TEMP "--" (OFF)

Press SET to scroll to  TEMP

Hold SET button until TEMP flashes.

To set  Night Time Temperature:

 = increases temperature.



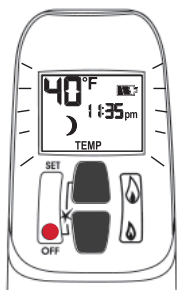

 = decreases temperature.

Press  or wait to complete setting.



Setting Program Timers



You can program two periods of time between 12 am and 11:50 pm in each 24-hour cycle.

Programs P1 and P2 must be set in the following order during a 24-hour cycle: P1 , P1 , P2  and P2 .

 = Day Time temperature (high) program period

 = Night Time temperature (low) program period





Default Settings:



Program 1: P1  06:00 am P1  08:00 am





Program 2: P2  11:50 pm P2  11:50 pm

Press SET to scroll to .



If P1  = P1  or P2  = P2 , programming is cancelled.

To keep fireplace ON all night, set P2  at 11:50 am and P1  at 12:00 am.

If you want to program only one period, program P1  and P1  with desired times then P2  and P2  with the same time as P1 .

Setting P1 time—high temperature.

Hold SET button until P1  is displayed and time flashes.

To set time:

 = hour

 = minutes

Press  or wait to complete setting.

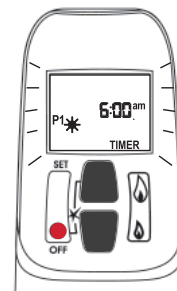

Setting P1 time—low temperature.

Hold SET button until P1  is displayed and time flashes.

To set time:

 = hour

 = minutes

Press  or wait to complete setting.

Using the Remote Control

Setting P2 high and low temperature times.

Repeat same steps as Setting P1.

When all settings are complete, press  to save them.

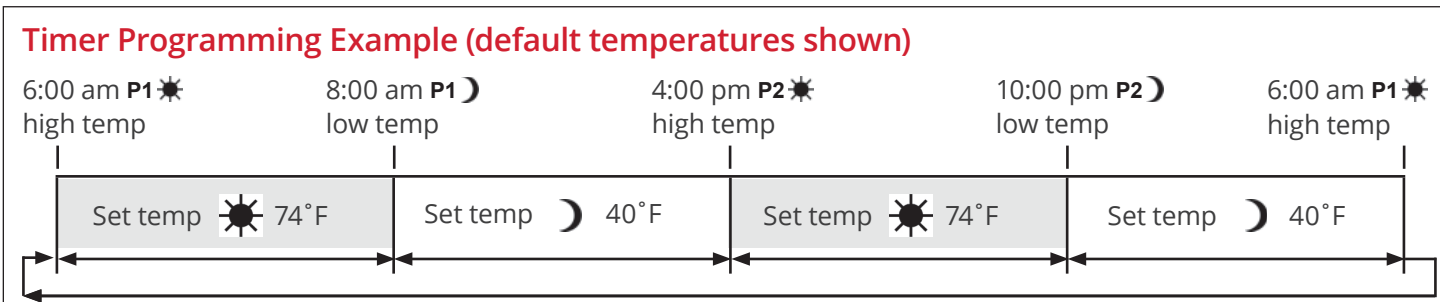

Automatic Turn Down

8-Hour no Motor Movement

The valve will turn to pilot flame if there is no motor movement for an 8-hour period.

Automatic Shut-Off

Low Batteries Receiver. With low battery power in the battery holder the system shuts off the fire completely. This does not apply when the power supply is interrupted.

On-Demand Pilot (7 Day Shut-Off). This green feature eliminates gas energy consumption during extended appliance inactivity. When the appliance is inactive for an extended period of time the system automatically extinguishes the pilot. This feature helps the consumer realize cost benefits by automatically eliminating energy consumption during non-heating months and limited use.

The programmed length of inactivity to activate the system is specified by the appliance manufacturer and cannot be altered in the field.

Low Battery Indication

Caution

DO NOT USE a screwdriver or other metallic object to remove batteries from holder. This could cause a short-circuit.

Handset: The battery icon  will show when the battery needs to be replaced. Replace with one 9 V **alkaline** battery.

Battery holder: Frequent 'beeps' for 3 seconds when the valve motor turns indicate the batteries need to be replaced in battery holder. Replace with four 1.5 V **alkaline** batteries.

Handset / Receiver Match

The remote control handset and receiver are programmed to function together. In case of a replacement of the handset or the receiver, you will need to reset the receiver to allow them to function together. Contact your dealer for details.

Required Kits

Information accurate at the time of printing and subject to change without notice.

Fuel Beds (choose one)		
739LSK	Traditional Log Set	
739RSK	Rock Set	
739DWK	Driftwood Kit	
Liners (choose one)		
739RGL	Reflective Glass Liners	
739FBL	Fluted Black Liners	
739VRL	Valor Red Brick Liners	
Inner Fronts (choose one)		Barrier Screen
741	Contemporary Steel Front	4003360
742	Traditional Cast Front	4003293
743	FenderFire Double Door	w doors
744	FenderFire Single Door	w door
745	Clearview Front	4003313

Optional Accessories

Information accurate at the time of printing and subject to change without notice.

Outer Surrounds, Trims & Frets	
See your dealer for your choice of Outer Surrounds, Trims & Frets.	
Conversion Kits	
738KNGK	Conversion to natural gas
738KPGK	Conversion to propane gas
Other Accessories	
770ZCK	Zero Clearance Kit
GV60CKO	Outdoor Fireplace Conversion Kit
Hearth Gate	Hearth gates such as Cardinal's VersaGates are available at retail stores carrying safety products for children.

Servicing Your Fireplace

We recommend having your fireplace serviced every year. Contact your supplier quoting the model number. It will be helpful if the appliance's serial number can also be quoted. These numbers are on the information card. The replacement parts are shown at the end of this manual. Please always quote the part number and description when requesting spare parts.

Annual Inspection

In order to maintain the safe operation of your fireplace, contact your dealer to have a qualified technician go over the list below and make the necessary verifications at least once every year.

Safe Operation List

To be performed by a qualified technician only

1. Clean glass window with a suitable fireplace glass cleaner. Abrasive cleaners must not be used. Be careful not to scratch the glass when cleaning. See *Cleaning Your Fireplace* section of this manual.
2. Inspect the operation of the flame safety system Pilot or Flame rectification device.
3. Inspect and ensure the lighting of the main burner occurs within 4 seconds of the main gas valve opening. Visual inspection should match that outlined in the appliance instruction manual. Inspect primary air openings for blockage. See *Checking Pilot and Burner Flame* section of this manual.
4. Inspect condition of vent and vent terminal for sooting or obstruction and correct if present.
5. Vacuum and clean any debris in the firebox that is not supposed to be there.
6. Test and measure the flame failure response time of the flame safety system. It must de-energize the safety shutoff in no more than 30 seconds.
7. Check all accessible gas-carrying tubes, connections, pipes and other components for leaks. See *Set up Gas Supply* section of this manual.

Cleaning Your Fireplace

⚠ WARNING

DO NOT TOUCH THE GLASS WHILE IT IS HOT!
Let the fireplace cool first before cleaning it.

Important - Glass cleaning - Mineral deposits

One of the by-products of the combustion process in a gas appliance is a mineral which can show up as a white film on the ceramic glass of the viewing door.

The composition of the deposit varies with location and time. It is believed to be associated with the varying sulfur content of the gas. You may have the problem intermittently.

We have consulted with ceramic glass manufacturers and they cannot offer a definitive solution to this problem. Dealers have tried various cleaning products with varying results. The following are recommendations only and are not meant to guarantee results.

NOTE: This is a problem beyond Miles Industries' control and is not covered under warranty.

- Clean the glass regularly as soon as you notice the buildup (white film). If the film is left for a longer period of time, it will etch into the glass. It is then much harder, if not impossible, to remove.
- **NEVER use an abrasive cleaner or ammonia-based cleaner on the ceramic glass.** Any abrasion of the surface has the immediate effect of compromising the strength of the glass. An emulsion type cleaner is recommended.
- Use a soft damp cloth to apply the cleaner. Dry the glass with a soft, dry, preferably cotton cloth. Most paper towels and synthetic materials are abrasive to ceramic glass and should be avoided.
- Our dealers have had good results from the products listed below. We cannot, however, guarantee the results of these products.
 - Brasso, Polish Plus by Kelkem, Cook Top Clean Creme by Elco, White Off by Rutland, Turtle Wax

Do not clean the glass while it is hot!

Always securely replace the window and the barrier screen before lighting.

If broken, the glass pane may only be replaced as a complete window unit as supplied by the manufacturer.

If the barrier becomes damaged, the barrier shall be replaced with the manufacturer's barrier for this appliance.

Clean the window panes following the guidelines in this section.

Clean the steel trim with mild soap and warm water. Any alcohol/solvent base cleaner will weaken the coating and damage it.

Clean the barrier screen dusting it with a soft brush.

Clean the firebox ceramic logs/rocks and walls dusting them with a soft brush. Dust can also be removed from the burner using a soft brush after removing the fuel bed. **When cleaning, make sure that no particles are brushed into the slots of the burner.**

To remove the window for cleaning:

1. Unhook the front with barrier screen.
2. On the window, turn each bolt a quarter turn to disengage the bolt pin.

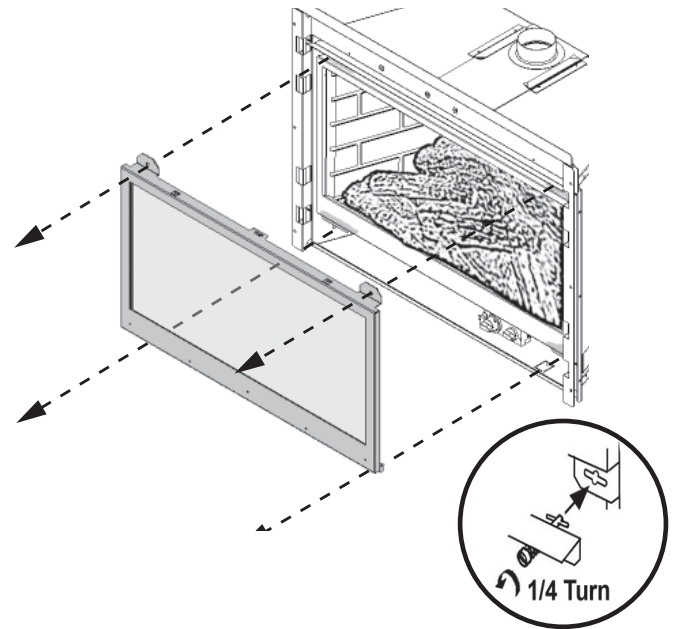

3. Gently pull the bottom of the window outward and unhook it from the firebox's opening frame.
4. Set the window aside in a safe place to avoid damage.

Servicing & Maintenance

To refit the window:

1. To refit the window, place the window to the firebox's opening frame. **Make sure that the wider part of the window frame is at the bottom.** The top of the window is marked.

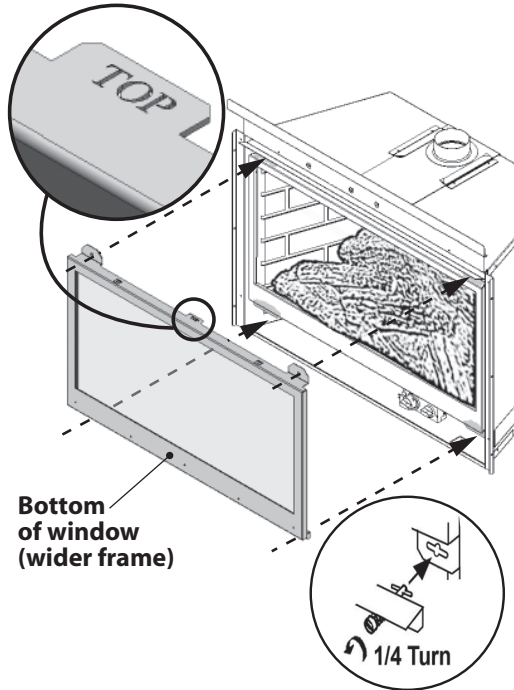

2. While you hold it, push in and turn the two bottom spring-loaded bolts a quarter turn to engage their pin.
3. Push in the top of the window against the firebox and fasten the two top spring-loaded bolts a quarter turn.

4. If the Hot Glass Warning plate has been removed from the front lower corner of the window, reinstall it by sliding it between the glass and the frame as indicated.

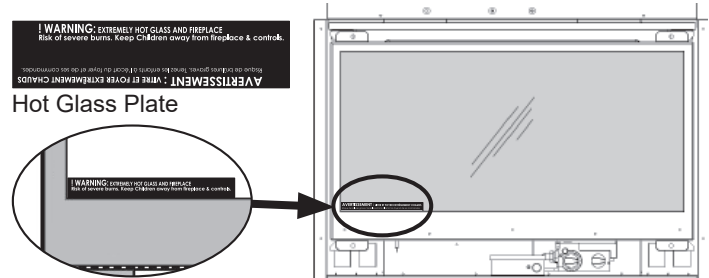

5. Reinstall the front and barrier screen.

! WARNING

FOR SAFETY PURPOSE, ensure the barrier screen is re-installed on the fireplace front after maintenance.

Servicing & Maintenance

Checking Pilot and Burner Flames

A periodic check of the pilot and burner flames should be made. Check after the fire has been on for at least 30 minutes. The pilot flame must cover the tip of the thermocouple probe. The main burner flame pattern will vary from appliance to appliance depending on the type of installation and climatic conditions.

The appliance area must always be kept clear and free from combustible materials, gasoline and other flammable vapors and liquids. Inspect the vent terminal outdoors regularly to make sure that dirt, snow, insects, leaves, shrubs, trees do not obstruct it. Examine the whole vent system regularly. We recommend annually.

Correct flame appearance



739LSK—Traditional Logs



739DWK—Driftwood



739RSK—Rocks

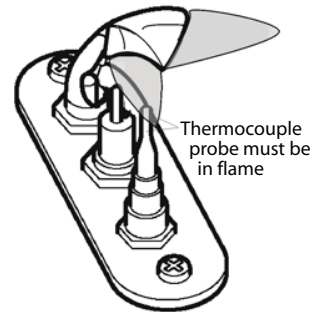

Pilot Flame can be seen on the left side of the fuel bed



Rock fuel bed

A black discoloration may form over time at the front bottom of the 6-rock original fuel bed; this deposit can be burned off by running the fireplace on a low to medium setting fire for 30 to 45 minutes. This discoloration is unavoidable and will re-form again.

Replacing Batteries

⚠ WARNING

DO NOT ATTEMPT TO CHANGE THE BATTERIES WHILE THE FIREPLACE IS STILL HOT! Let the fireplace cool first before touching it.

CAUTION

DO NOT USE a screwdriver or other metallic object to remove the batteries from the receiver or the handset! This could cause a short circuit to the receiver.

Low battery signal: see page 12.

BEFORE changing the batteries, disconnect the battery holder from the receiver.

The appliance uses four 1.5 V AA **alkaline** batteries for its battery holder and one 9 V **alkaline** battery for its handset. Batteries should last one to two seasons, depending on usage. Removing the batteries in the off-season will extend the battery life. Should the batteries lose power, the control may be operated by manually turning the control knob at the valve.

To replace the batteries in the battery holder:

1. The battery holder is located underneath the firebox behind the front trim. Remove the front trim. Grab the battery holder and pull it out from its location.

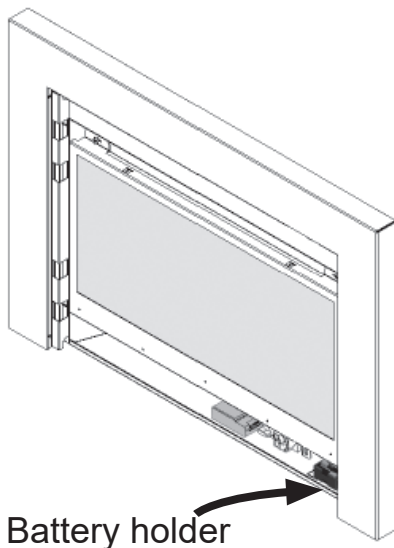

2. Disconnect the battery holder.

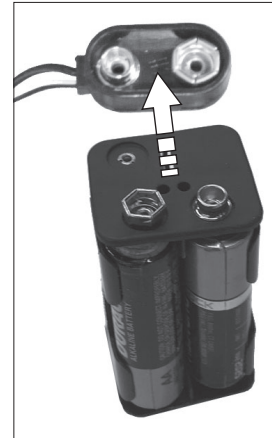

3. Replace the batteries with 4 AA **alkaline** batteries.
4. Reconnect the battery holder.
5. Put the battery holder back in its position.
6. Reinstall the front trim.

Using Handset Wall Holder

Your fireplace equipment includes a wall holder to store the handset. If it hasn't been installed, refer to the instructions further on in this manual for the installation.



Specifications

Approval & Codes

This appliance is certified to ANSI Z21.88 / CSA 2.33 American National Standard / CSA Standard for *Vented Gas Fireplace Heaters* for use in Canada and USA, and to CGA 2.17-91 *High Altitude Standard in Canada*. This appliance is for gravity vent insert installations.

This appliance complies with CSA P.4.1-15 *Testing method for measuring annual fireplace efficiencies*.

The installation must conform to local codes or, in the absence of local codes, with the *National Fuel Gas Code, ANSI Z223.1/NFPA 54* or the *Natural Gas and Propane Installation Code CAN/CGA-B149.1*. Only qualified licensed or trained personnel should install this appliance.

This appliance must be electrically grounded in accordance with local codes, or, in the absence of local codes, with the *National Electrical Code, ANSI/NFPA 70* or the *Canadian Electrical Code, CSA C22.1*.

Ratings

Model	KN	KP
Gas	Natural	Propane
Altitude (Ft.)*	0-4,500 feet*	
Input Maximum (Btu/h)	24,000	24,000
Input Minimum (Btu/h)	6,500	13,000
Manifold Pressure (in w.c.)	3.95	9.5
Minimum Supply Pressure (in w.c.)	5.0	11.0
Maximum Supply Pressure (in w.c.)	10.5	14.0
Main Burner Injector Marking	82-650	92-260
Pilot Injector Marking	35	27
Min. Rate By-Pass Screw	125	125

*High Altitude Installations

Input ratings are shown in BTU per hour and are certified without deration for elevations up to 4,500 feet (1,370 m) above sea level.

For elevations above 4,500 feet (1,370 m) in USA, installations must be in accordance with the current ANSI Z223.1 and/or local codes having jurisdiction. Heating value of gas in some areas is reduced to compensate for elevation—consult your local gas utility to confirm.

For installations at elevations above 4,500 feet (1,370 m) in Canada, please consult provincial and/or local authorities having jurisdiction.

Supply Gas

Heater engine 738KN is used with natural gas. Heater engine 738KP is used with propane gas. The supply pressure must be between the limits shown in the Ratings section above.

The supply connection is 3/8" NPT female and located on the left hand side of the control valve. The gas line entry point is on the left hand side on the fireplace.

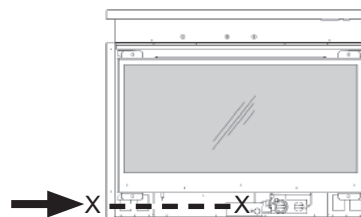

Conversion Kits

The 738 G3 is supplied as natural gas or propane gas and is field convertible between fuels.

See instructions packaged with the conversion kit for further information.

Electrical

The 738 does not require an electrical power source to operate as a heater.

Floor/Hearth

This appliance is approved for installation into existing solid-fuel burning fireplaces only. Combustible material such as plywood and so on may be used for leveling and shimming beneath the unit. This appliance does not require a hearth other than to support the weight of certain fronts.

Outdoor Conversion Kit

The 739M models are supplied standard for indoor applications and may be adapted for installation in specific "outdoor" applications protected from weather as defined in the GV60CKO outdoor conversion kit manual.

This appliance is designed and approved as a supplemental heater and provides the potential for most energy conservation when used while attended. The use of an alternate primary heat source is advisable.

This appliance, as supplied, may **ONLY** be installed in an existing unaltered, functioning solid-fuel burning fireplace with a working flue and constructed of non-combustible material.

This appliance may be installed in outdoor, weather-protected environments as defined in the GV60CKO Outdoor Conversion Kit instruction manual.

This appliance is **APPROVED** for installation into combustible type construction only when using the 770ZCK Zero Clearance Kit (see separate instructions packaged with the kit for details).

⚠ WARNING

Some materials or items, although safe, may discolor, shrink, warp, crack, peel, and so on because of the heat produced by the fireplace. Avoid placing candles, paintings, photos, and other items sensitive to heat around the fireplace.

⚠ WARNING

HOT HEARTH / FLOOR! The hearth or floor in front of the fireplace may become very hot when the fireplace heats. Do not use the hearth as a seat or shelf. Solid wood flooring in front of the fireplace (if allowed) may shrink during the heating season due to heat.

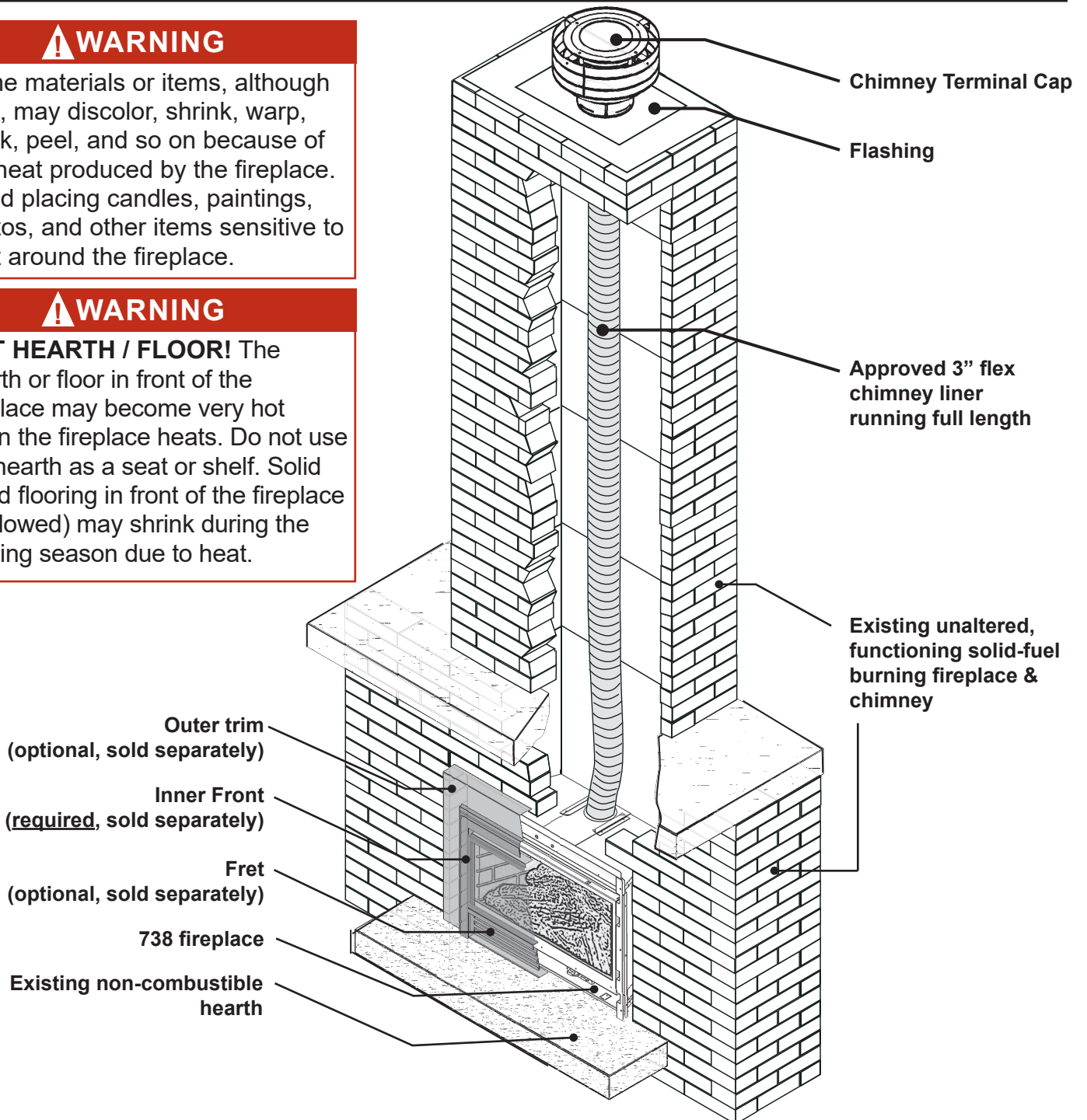

Dimensions

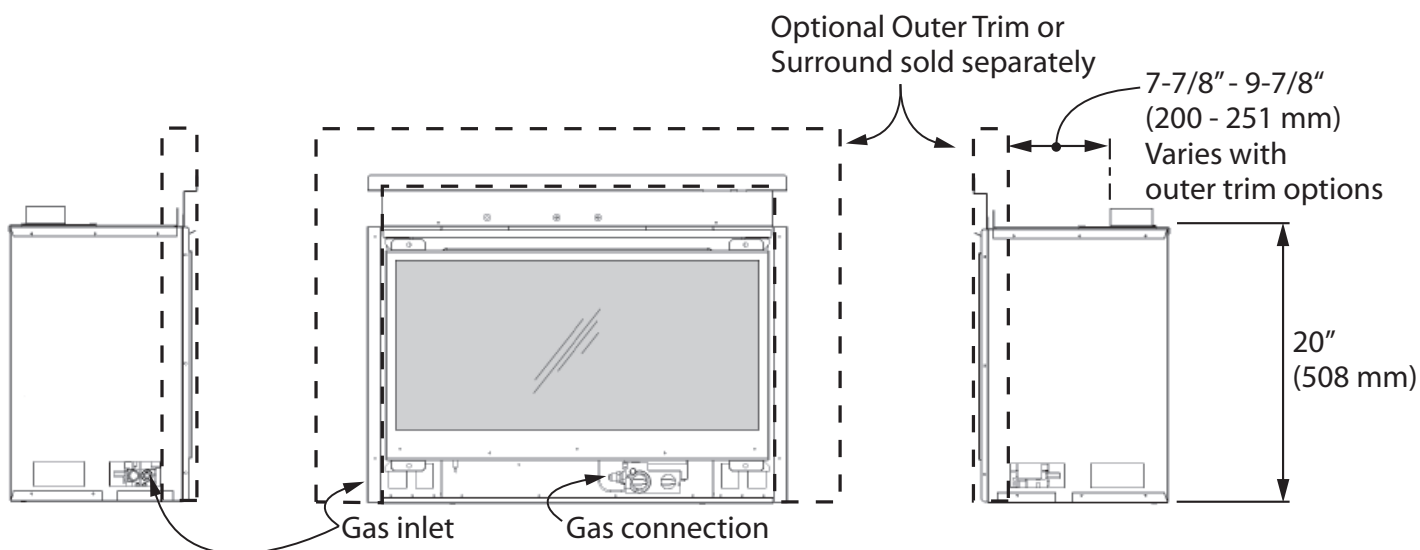
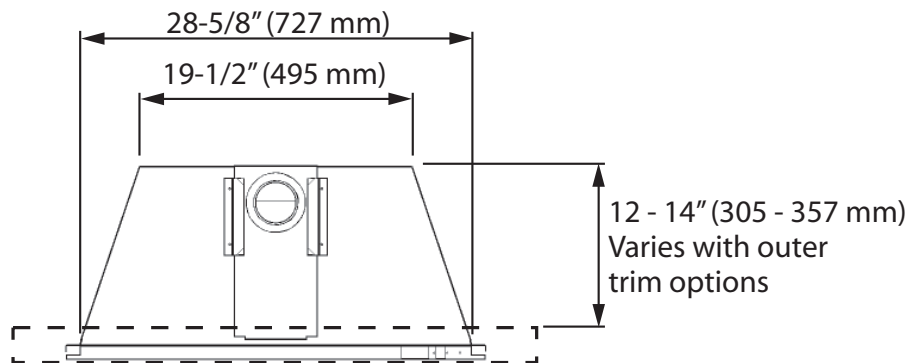

Cavity

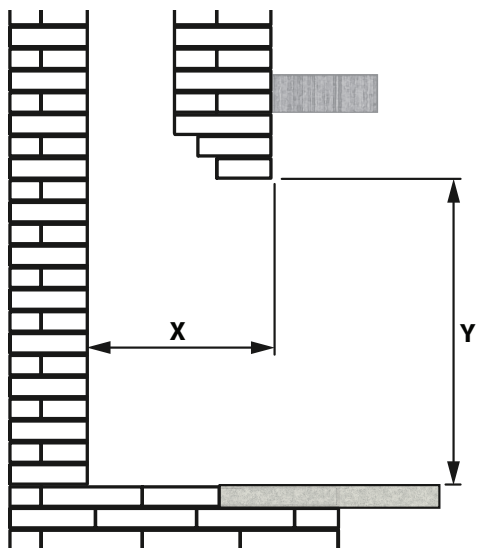

Check that masonry step does not interfere with install dimensions or vent pipe.

If mantel is combustible, see section *Clearances* for allowable clearances.

Minimum width of fireplace opening at front: 28" (711 mm)

X = 12-14" (305-357 mm)—varies with outer trim options
Y = 20-1/4" (514 mm)

Clearances

⚠ WARNING

Some materials or items, although safe, may discolor, shrink, warp, crack, peel, and so on because of the heat produced by the fireplace. Avoid placing candles, paintings, photos, and other items sensitive to heat around the fireplace.

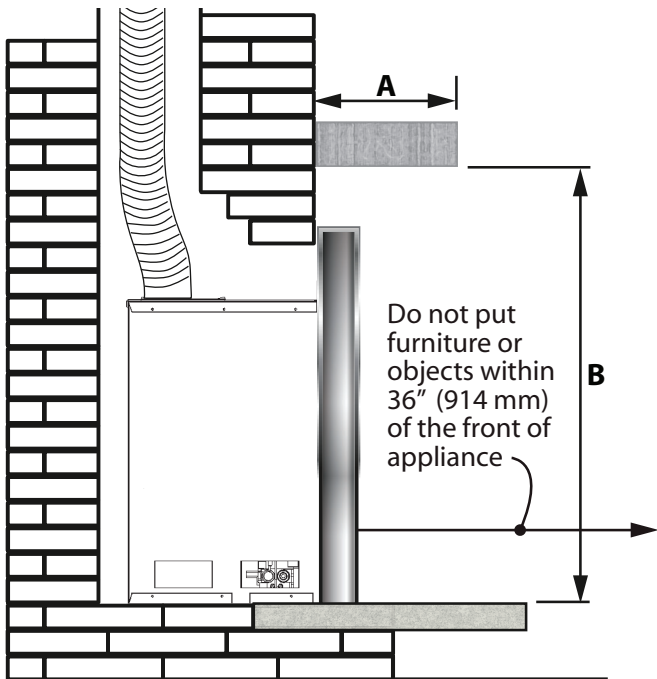

Combustible Mantel Clearances

Mantel Projection A	1" (25 mm)	1"–6" (25–152 mm)	9" (229 mm)	12" (305 mm)
Mantel Height B*	36" (914 mm)	39" (991 mm)	42" (1067 mm)	45" (1143 mm)

*Measure taken from the underside of the mantel to finished hearth or surface that the unit is sitting on.

Finishing Materials

Combustible materials: Materials made of or surfaced with wood, compressed paper, plant fibers, plastics, or other material that can ignite and burn, whether flame proofed or not, or plastered or unplastered.

Non-combustible materials: Material which will not ignite and burn. Such materials are those consisting entirely of steel, iron, brick, tile, concrete, slate, glass or plasters, or any combination thereof.

Materials that are reported as passing ASTM E 136, Standard Test Method for Behavior of Materials in a Vertical Tube Furnace at 750 °C

⚠ WARNING

HOT GLASS! The use of a screen in front of the glass is highly recommended particularly in households with children.

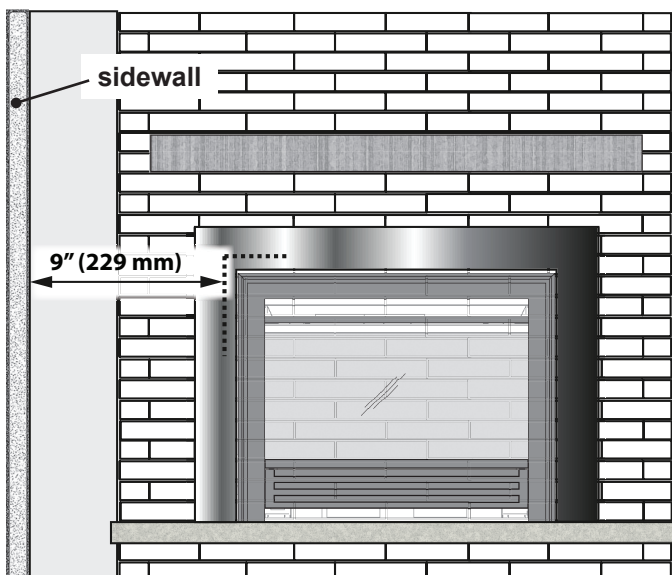

⚠ WARNING

HOT HEARTH / FLOOR! The hearth or floor in front of the fireplace may become very hot when the fireplace heats. Do not use the hearth as a seat or shelf. Solid wood flooring in front of the fireplace (if allowed) may shrink during the heating season due to heat.

Sidewall Clearances

Minimum distance from side of appliance (liner box) to combustible wall: 9" (229 mm).

Mantel legs projecting forward less than 6" (152 mm) may be located within 5" (127 mm) of the side of the appliance (liner box).

Floor/Hearth Clearances

Combustible shims/supports may be used beneath the appliance to level or raise the appliance within the existing fireplace cavity.

Combustible flooring/hearths in front of the appliance are allowed provided they are no higher than the base of the appliance. Carpet, vinyl flooring should be kept back to a minimum of 12" (305 mm) from the front of the insert. The gas insert does not require a hearth.

Venting

Vent Location

The vent terminal must be located through the roof. This gravity vent appliance is designed to operate when an undisturbed airflow hits the outside vent terminal from any direction. Check local codes for allowable vertical vent termination.

Vent Materials

Use a 3" diameter aluminum flex liner approved for gas venting when installed as an insert (existing chimney). Use a 4" diameter type "B" vent when installed with a 770ZCK Zero Clearance Kit (see separate instructions packaged with the kit for details).

Venting Notes

Where possible, avoid joining flex pipe. If joints are required, use an approved connector and seal joints with *RTV high temp sealant*.

Horizontal offsets are permissible to allow for routing around masonry projections. Avoid bending flex pipe over a 45 degree radius where possible.

Typical Vent Installation

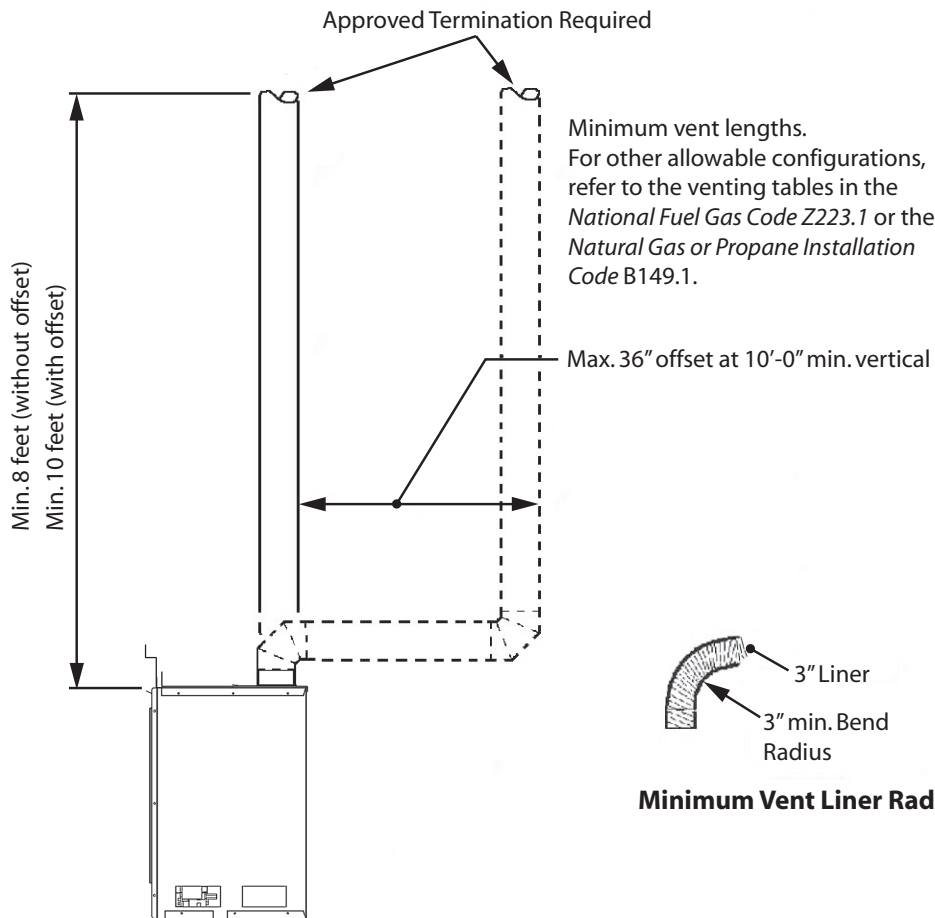
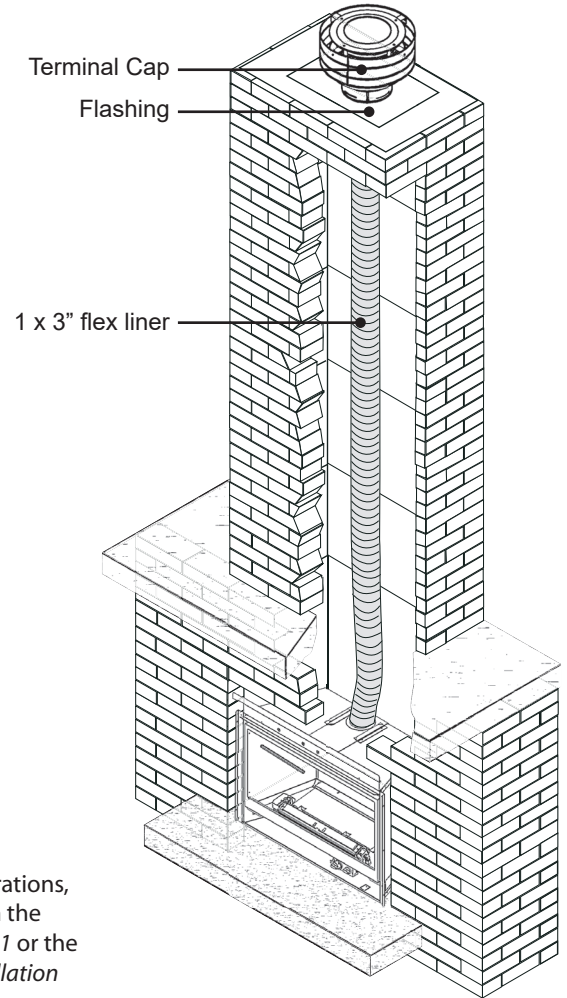

Minimum Vent Liner Radius

Allowable Vent Configurations

Installer—READ THIS FIRST

1. **YOU NEED TO KNOW FROM THE HOMEOWNER** what accessories (surround, door, etc.) will be installed with this fireplace;
2. Unpack the appliance including items around the fireplace. Recycle cartons.
3. Using the Pack Content, check that you have everything for the installation, including:
 - Fuel bed (packed separately)
 - Liner panels (packed separately)
 - Venting accessories
 - Optional accessories
4. Carefully read the Installer's Checklist included with the fireplace's documentation for the installation sequence.

Only qualified licensed or trained personnel should install this appliance.

Existing Fireplace Preparation

A few points must be considered before inserting the 738K into an existing fireplace cavity. Generally, no modifications are allowed to the existing fireplace that will compromise the integrity of the existing fireplace. Components that are bolted or screwed on such as dampers or baffles may be removed to accommodate the installation of the 738K engine. **Cutting away any sheet metal parts of the existing fireplace to accommodate the installation of the 738K is prohibited.** Check with local authorities if in doubt.

Clean Fireplace and Chimney

Have the chimney swept and the fireplace cavity including ash dumps and clean-outs cleaned before installing the 738K heater and vent liners. Any creosote or soot residue remaining in the fireplace cavity chimney or clean-out may cause odors or stains once the 738K insert is installed. Consult with chimney sweep for information on how best to clean.

Existing Dampers

Factory-built, zero-clearance fireplaces will require the damper to be removed in order to install the vent liners. These dampers are usually bolted into place. Dampers in masonry fireplaces must be fixed open and may remain in place.

Ash Retaining Curbs

Some fireplaces (particularly factory-built) have a raised curb at the front edge to retain ashes. Check the dimensions carefully to ensure the 738K engine will fit behind any raised curb (some curbs may be removed separately from the refractory base).

Gas Line Routing

Plan the routing of the gas line before proceeding. Use the existing hole for the gas line in factory-built fireplaces. If the fireplace has no access hole, carefully drill an access hole of 1.5 inch (38 mm) or less through the lower sides or bottom of the firebox. The access hole must be plugged with non-combustible insulation after the gas supply line has been installed. See *Dimensions* section for detailed location of gas inlet. Also, take into consideration whether or not a shut-off valve will interfere when planning routing of the gas line.

Existing Fireplace Preparation

Existing Glass Doors and Wire Screens

Existing glass doors must be permanently removed prior to installing the 738K insert.

Combustible Mantels

Combustible mantel clearances must conform to those required for the original solid-fuel fireplace into which the 738K is being installed.

Attach Warning Conversion Plate to Existing Fireplace (label supplied loose with 738K heater)

Attach the "This fireplace has been converted..." label **to the existing fireplace** using screws or other mechanical means and store any removed parts in back of the existing fireplace for future use.

Installation

Unpack the appliance

Beware of sharp edges! Wear gloves!

1. Unpack the appliance.
2. Unpack any loose items from around the appliance and check against the Pack Content list provided in the documentation package.
3. Remove the window and set aside in a safe place to avoid damage.
4. **Verify that you have all the components required for the installation, including:**
 - *brick panels & logs;*
 - *surround/doors/fret;*
 - *venting components and accessories.*

Remove Window

The window is held in place by four spring-loaded bolts, two at the top and two at the bottom.

1. To remove the window, turn each bolt a quarter turn to disengage the bolt pin.
2. Gently pull the bottom of the window outward and unhook it from the firebox's opening frame.
3. Set the window aside in a safe place to avoid damage.

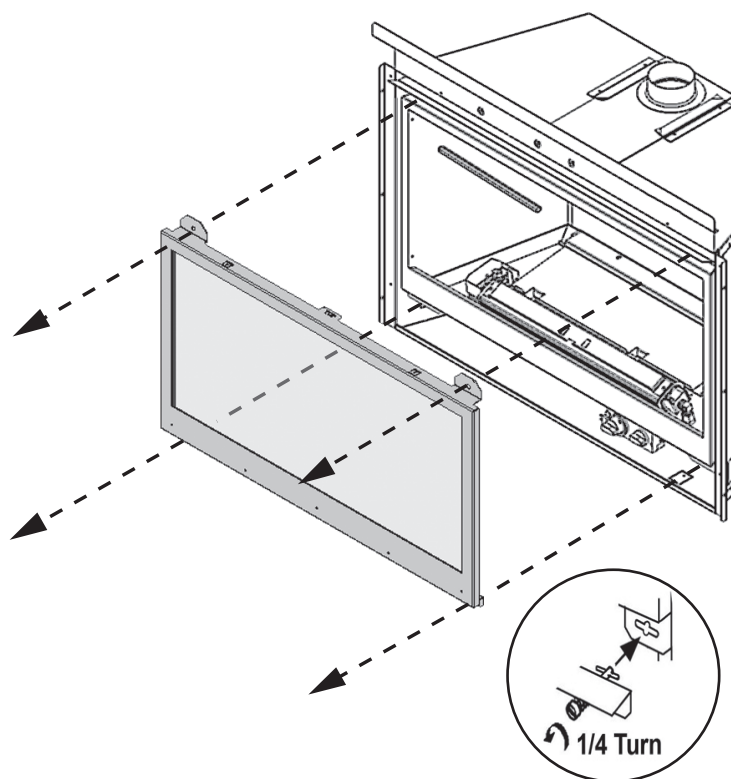

Connect Vent

IMPORTANT: This appliance's venting system requires room air to be used in the combustion process.

1. Rough-in one 3" diameter vent liner into the existing chimney system from the roof. Be careful not to tear or damage the liner in the process. Leave plenty of liner at the bottom to facilitate the connection of the liner to the vent slider. **It is best to leave the top termination until later.**
2. Release the two screws retaining the vent slider to the front of the firebox. Remove the slider from the firebox by sliding it towards the back of the firebox.
3. Secure the liner to the collar on the vent slider using the hose clamp (included) and 2 tapping screws per liner.
4. Slide the firebox onto the vent slider in the cavity taking care not to damage the liner. **Make sure that the vent slider is pulled all the way forward.** Secure the vent slider to the front of the firebox with two screws removed earlier.
5. From the roof, pull the liner and fit the flashing.
6. Fit the terminal cap. Secure with screws.
7. Seal the terminal and flashing from water penetration as required.

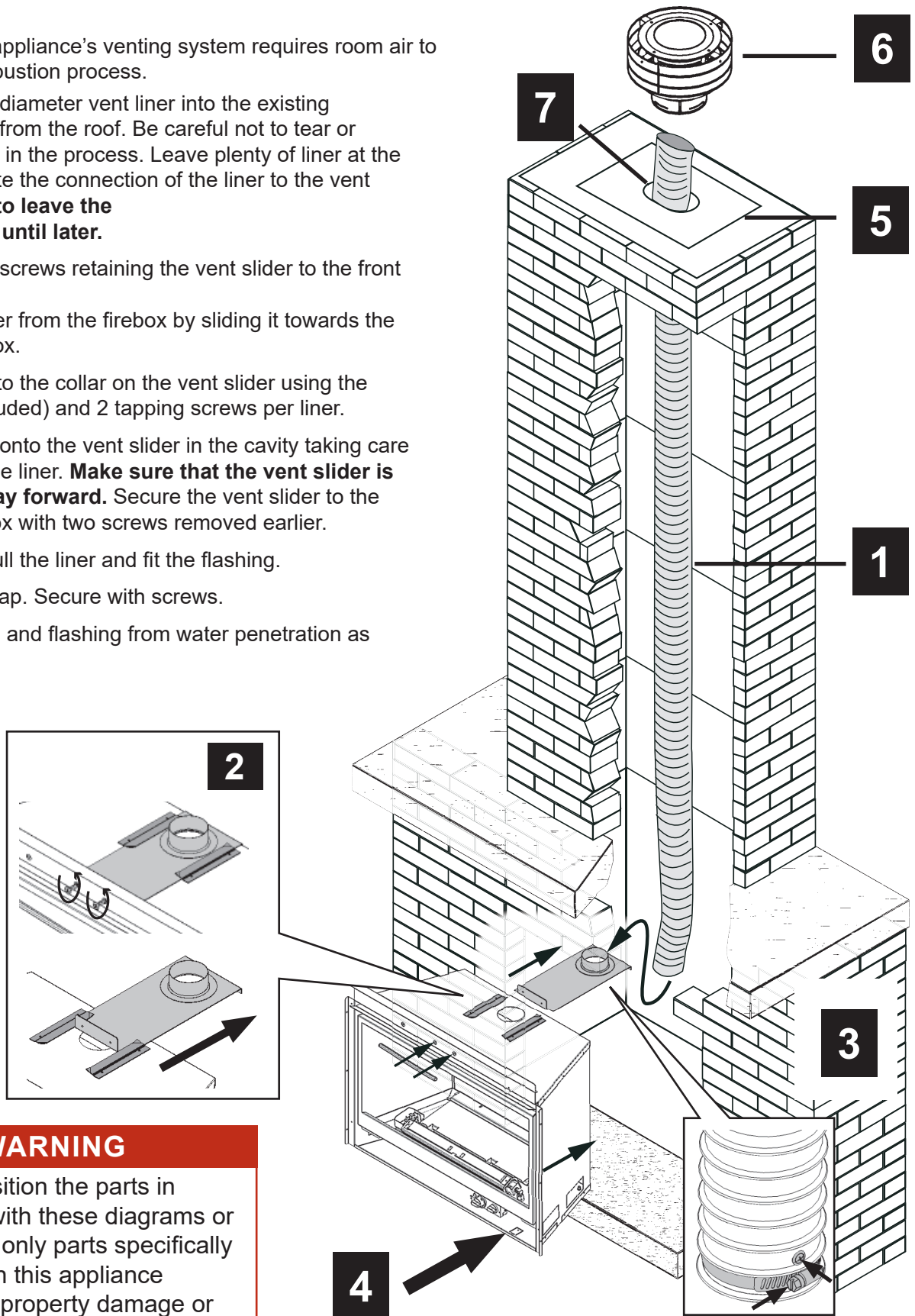

⚠ WARNING
Failure to position the parts in accordance with these diagrams or failure to use only parts specifically approved with this appliance may result in property damage or personal injury.

Installation

Connect Gas Supply

The gas supply inlet connection is a 3/8" NPT female connector and is located on the left hand side of the control valve.

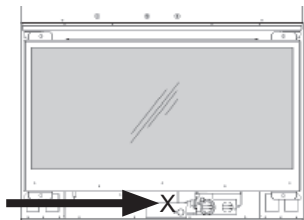

Use only new black iron or steel pipes, CSST, or copper tubing if acceptable—check local codes. Note that in USA, copper tubing must be internally tinned for protection against sulfur compounds.

The burner platform and gas train on this appliance may be removed as a unit for servicing or to install or remove the optional circulating fan (if installed). Provide some form of pipe union (depending on type of piping) as close as possible to appliance valve.

Unions in gas lines should be of ground joint type.

The gas supply line must be sized and installed to provide a supply of gas sufficient to meet the maximum demand of the appliance without undue loss of pressure.

Sealant used must be resistant to the action of all gas constituents including propane gas. Sealant should be applied lightly to male threads to ensure excess sealant does not enter gas lines.

Pressure test the supply line for leaks.

The appliance and its individual shut-off valve must be disconnected from the gas supply piping system during any pressure testing of that system at test pressures in excess of 1/2 psig (3.5 kPa).

The appliance must be isolated from the gas supply piping system by closing its equipment shut-off valve during any pressure testing of the gas supply piping system at test pressures equal to or less than 1/2 psi (3.5 kPa).

Failure to either disconnect or isolate the appliance during pressure testing may resulting regulator or valve damages and void the warranty. Consult your dealer in case of damages.

Pressure Test Points

The minimum supply pressure is given in the section *Specifications* of this manual—page 19.

All piping and connections must be tested for leaks after installation or servicing. All leaks must be corrected immediately.

When testing for leaks:

- Make sure that the appliance is turned off.
- Open the manual shut-off valve.
- Test for leaks by applying a liquid detergent or soap solution to all joints. Bubbles forming indicate a gas leak.

! WARNING

**NEVER use an open flame to check for leaks!
Correct any leak detected immediately.**

The pressure test tapping locations are shown in the figure below. An internal regulator within the valve controls the burner manifold pressure. The correct pressure range is shown in the table in section *Specifications* of this manual on page 19. The pressure check should be made with the burner alight and at its highest setting. See *Lighting Instructions Plate* for full operating details on page 8.

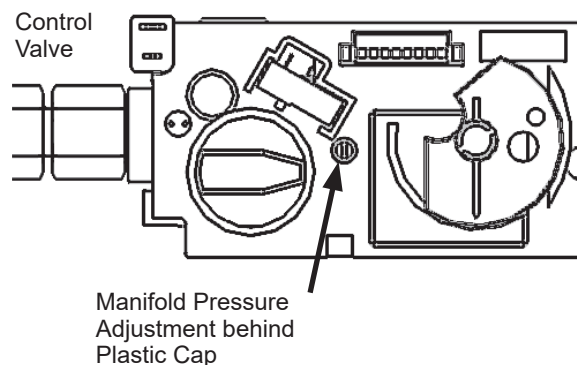
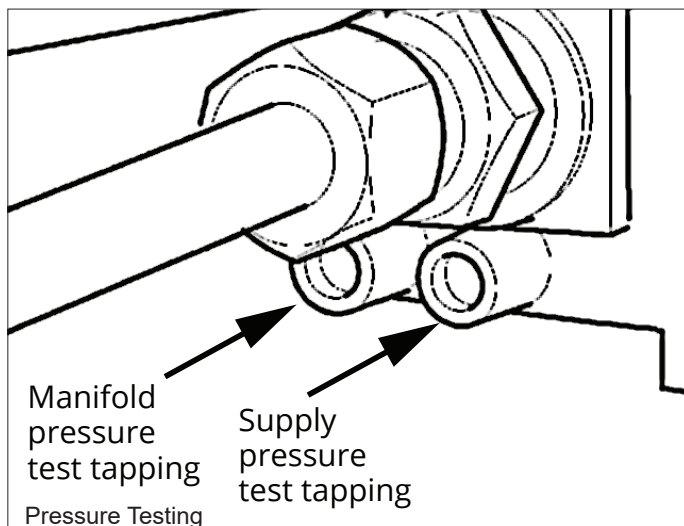

Installation

Adjust Fuel Bed Support (if necessary)

The appliance is supplied with the fuel bed support already installed. All fuel beds can be used with this support.

The fuel bed support is factory-installed in a specific position and include a front flange which can be adjusted if necessary. To adjust the position of the flange, release its 3 retaining screws and move the flange as required. Tighten the screws.

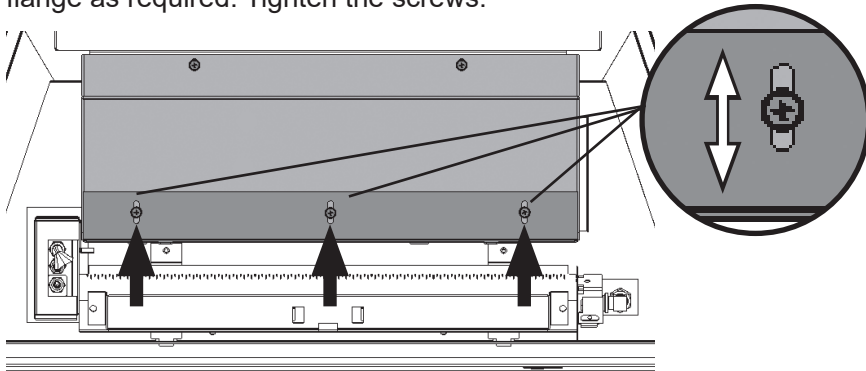

Moving the flange forward will allow more impingement/glow/flame height; moving the flange backward will do the opposite.

Note: The rock support included with the Rock Set 739RSK it is no longer necessary; recycle or discard it.

Install Liner Panels

The following guidelines apply for all liners **except the 739RGL Reflective Glass Liners** which require some preparation prior to installation—see instructions packed with liners.

1. Inside the firebox, on the top of each side, release the screw of the side brick anchors (one per side) just enough to allow them to rotate.

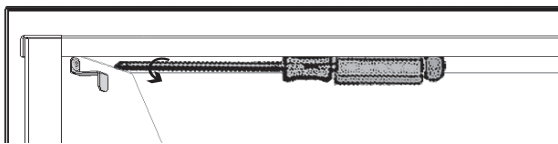

2. Place the rear panel against the back of the firebox, on the ledge at bottom.

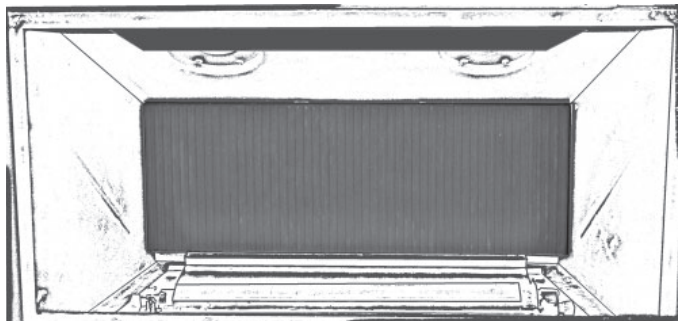

3. Rotate the anchor up and out of the way and slide the left hand side panel against the firebox side. **The panel should be parallel to the edge of the burner plate.** Rotate the anchor back down to hold the panel.



Rotate anchor up and insert panel

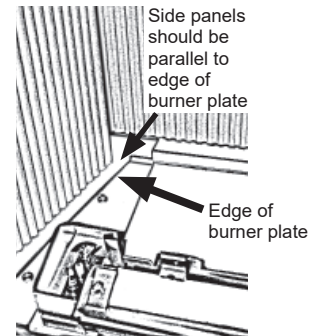

Position of panel in relation to burner plate

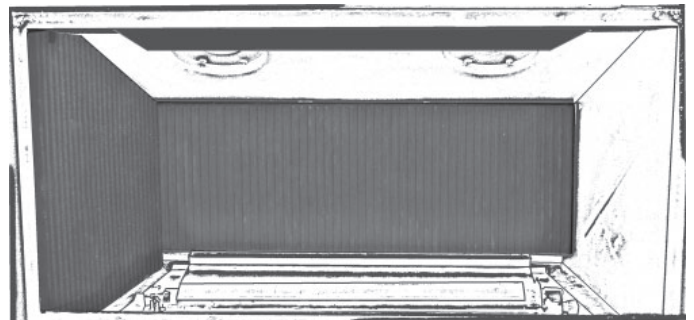

4. Rotate the anchor up and out of the way and slide the right hand side panel against the firebox side. **The panel should be parallel to the edge of the burner plate.** Rotate the anchor back down to hold the panel.

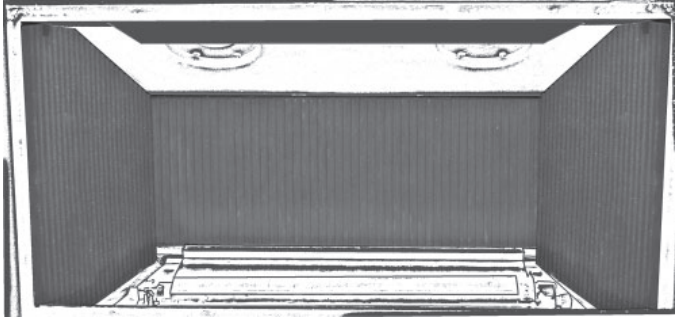

5. Tighten the side brick anchors on each side of the firebox.

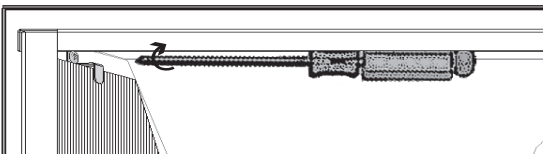

Installation

Install 739LSK Traditional Logs

Unpack the ceramic logs very carefully to avoid damaging the fragile material. Install the logs as shown below. Please note that **the position of the logs is critical to ensure proper performance of the appliance.**

1. Place the rear log on the sheet metal support centering it side to side in the firebox. Pull it forward until the notch in the underside of the log sits against front edge of the sheet metal support.

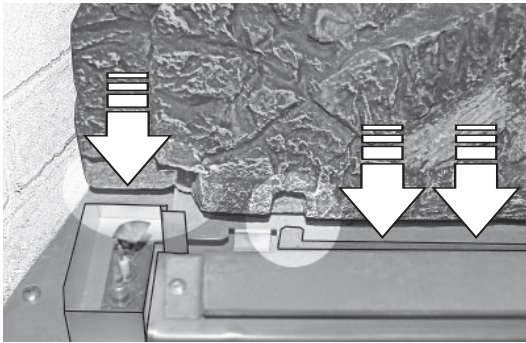
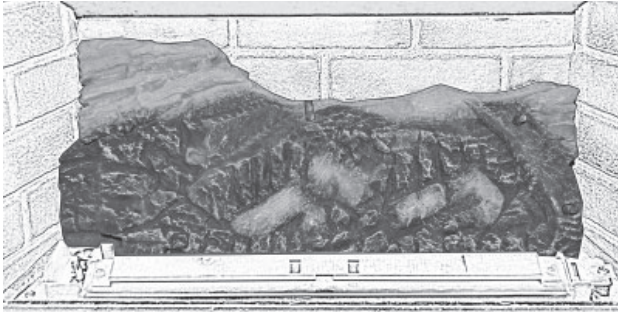

2. Place the top left log on the pin of the rear log. The bottom of the log rests against the left of the pilot shield and slightly above.

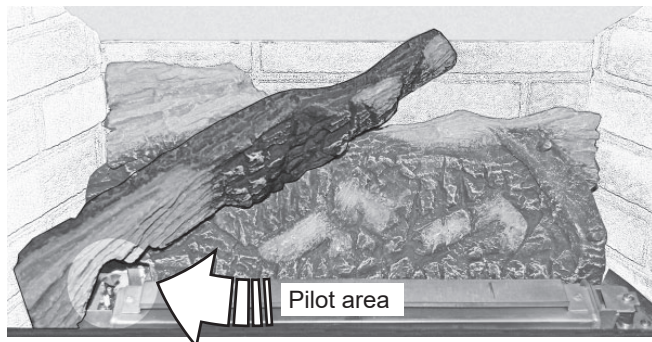

3. Place the front left log on the burner. Slide it to the left against the top left log. The narrow end should rest in the notch in the rear log.

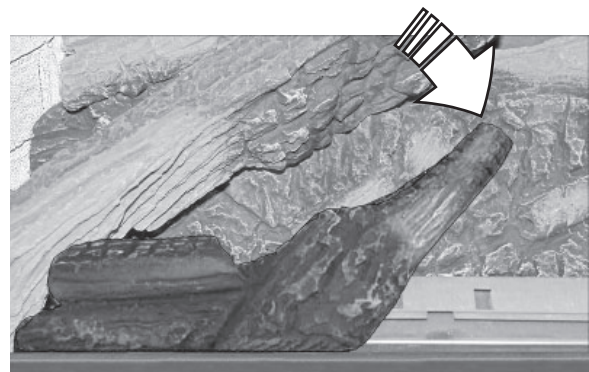
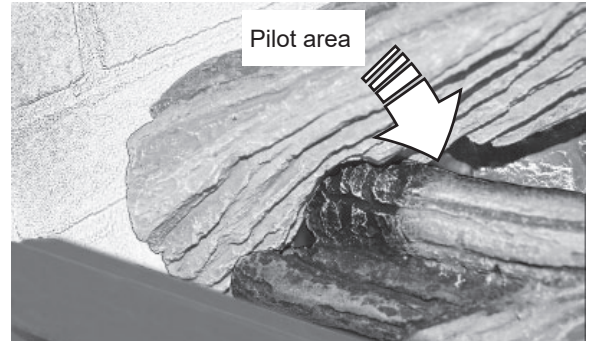

4. Place the front right log on the burner and slide it to the left against the front left log.



5. Locate the top right log on the two pins on the right side of the rear log. Ensure a tight fit against the flat area around the pins in the rear log.

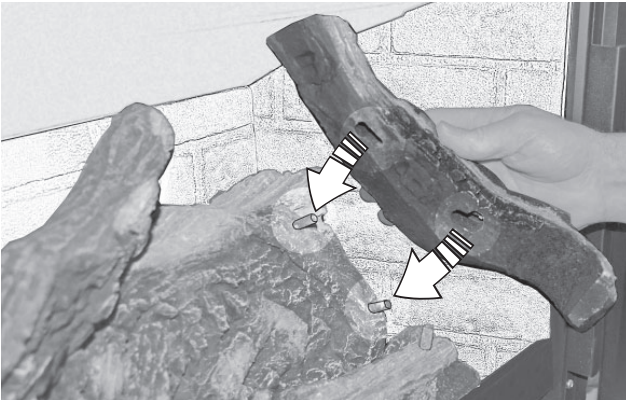

6. Place the lower end of the center right log onto the pin on the front right log. Rest the narrow end in the notch into the rear log.

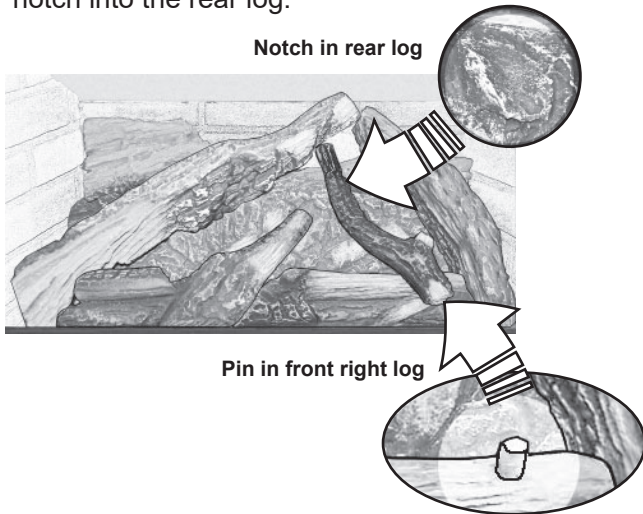

7. Pour some ceramic loose coals on each side of the logs to hide the sheet metal work. **Do NOT put any coal into the pilot area.**



Installation

Install 739RSK Ceramic Rocks

Unpack the ceramic rocks kit very carefully to avoid damaging the fragile material. Install the components as shown below. Please note that **the position of the rocks and twigs (if used) is critical to ensure proper performance of the appliance.**

1. Install the Front Support Platform in the firebox carefully sliding it down between the burner and the front bottom edge for the firebox while avoiding scraping the side ceramic panels.

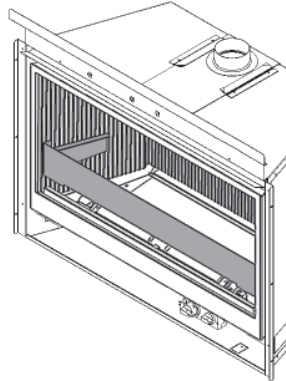
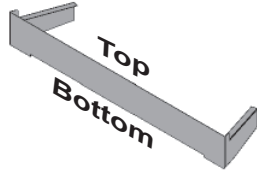
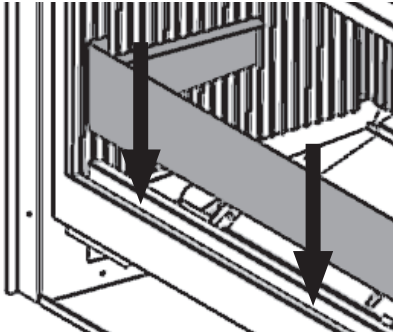

2. Place the rock ceramic base on the log support behind the burner. The front bottom of the base must rest against the lip of the support.

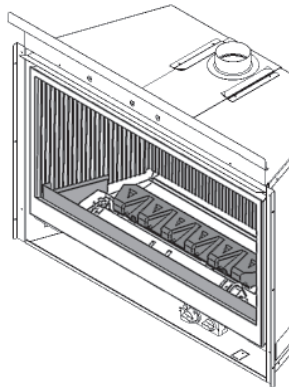
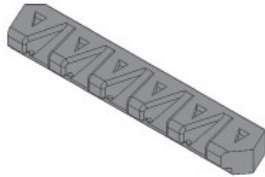
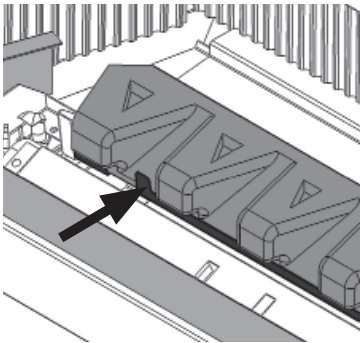

3. Install the ceramic platform in the firebox rotating down to insert the front first behind the Front Support. Lay the back of the ceramic platform against the rear ceramic panel again being careful not to scrape the ceramic panels.

Warning: This platform is quite fragile. DO NOT force it in place.

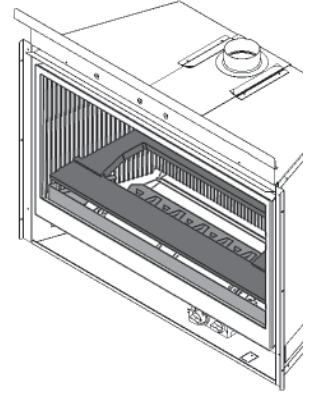
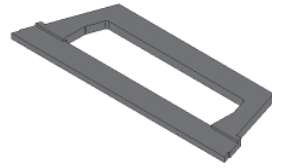
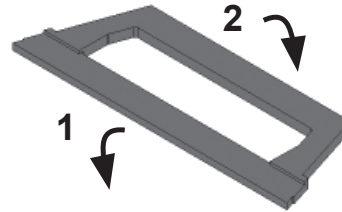

**Fuel Bed Base
Installed**

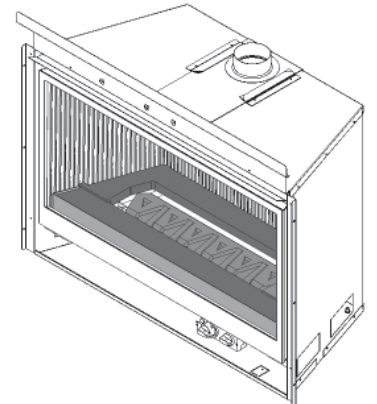

Installation

4. The underside of each ceramic rock is identified by a number and a specific protruding positioning triangle.



Rock identification



Triangular hole in ceramic base

Install the six rocks from left to right starting with rock no. 1.

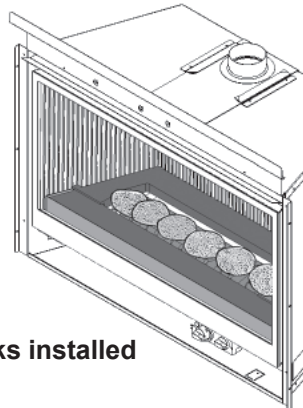
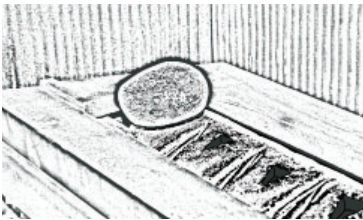

All Rocks installed

A black discoloration may form over time at the front bottom of the 6-rock original fuel bed; this deposit can be burned off by running the fireplace on a low to medium setting fire for 30 to 45 minutes. This discoloration is unavoidable and will re-form again.

5. Place the glass panel in its cavity formed by the Front Support and the Ceramic Platform.

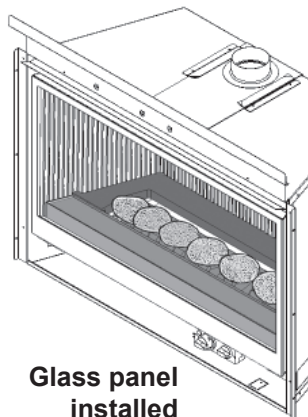
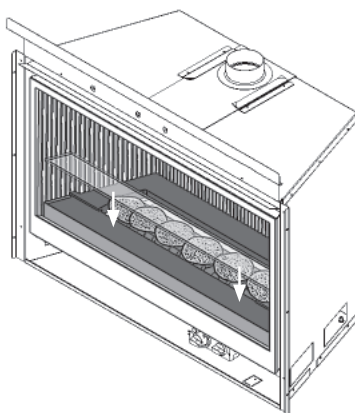

Glass panel installed

6. Place the left twig across the second and third rocks from the **left**; rest its end on the glass near the edge of the platform as shown below. **Make sure to leave a gap between the twig and the first rock to allow flame to come up between the twig and the rock.**



7. Place the right twig across the second and third rocks from the **right**; rest its end on the glass about 1 cm from the edge of the platform as shown below. **Make sure to leave a gap between the twig and the first rock to allow flame to come up between the twig and the rock.**

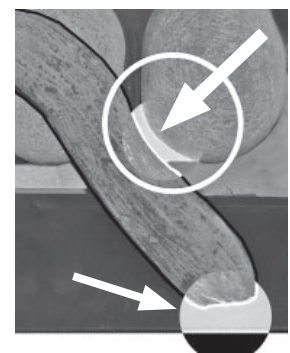
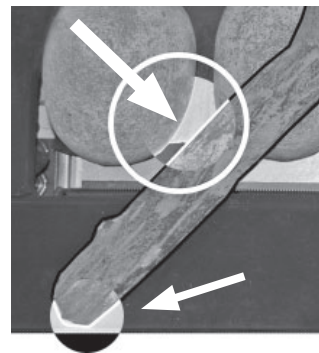
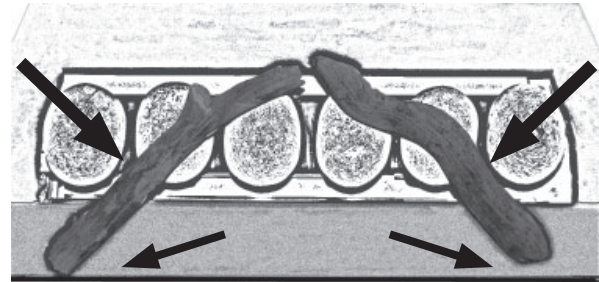

Installation

Install 739DWK Driftwood Kit

Unpack the driftwood kit very carefully to avoid damaging the fragile material. Install the components as shown below. Please note that **the position of the logs and pebbles (if used) is critical to ensure proper performance of the appliance.**

Platform

Place the platform into the firebox on top of the burner.

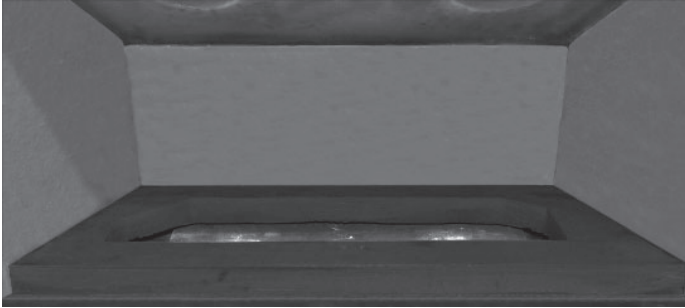

Logs

1. Identify the base log and place it in the cavity of the ceramic platform. The protruding parts of the log in the front should rest against the lip of the sheet metal log support behind the burner.

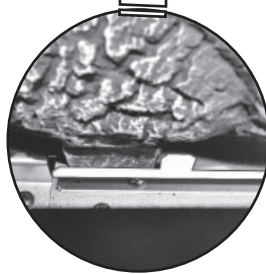
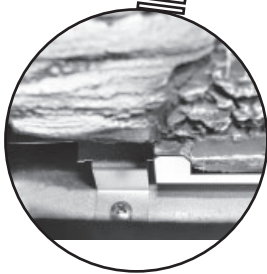
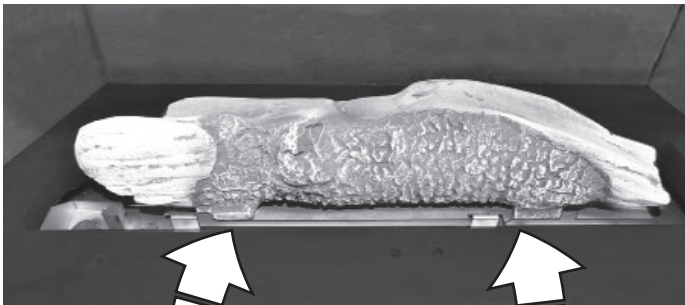

2. Identify the rear log and place it on top of the base log locating it into the notches on top of the log. Pull the log forward so it is locked in position.

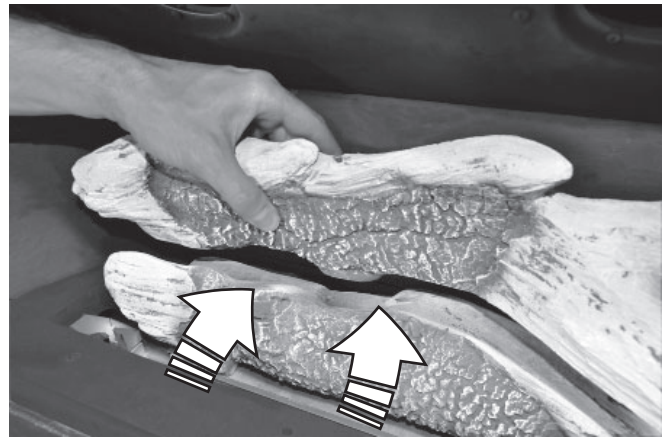

3. Place the front log inserting its two pins into the two holes at the front of the platform. The ends of the log should be oriented towards the front as the log should not hang over the inside edge of the platform.

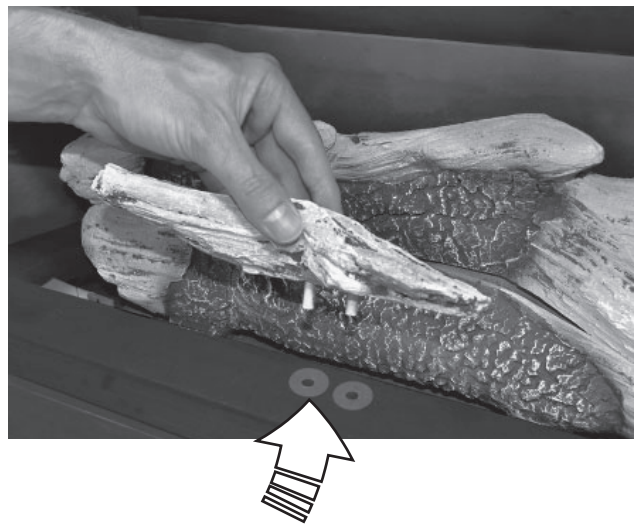

Installation

4. Identify the right side cross log, the longest, and place it across the rear log. The narrow end of the log rests in a notch of the rear log. The wide end of the log lays flat on the platform, flush with the edge as indicated.



Pebbles

Six pebbles are supplied as decorative elements. If used, they should be placed on the platform only. We suggest to place the larger ones to cover the inside edge corners of the platform and place others randomly. Not all of them have to be used.



5. Identify the left side cross log which has one pin at one end. Insert the pin in the hole at the front left of the platform and rests the top part of the log into the notch of the rear log as indicated.

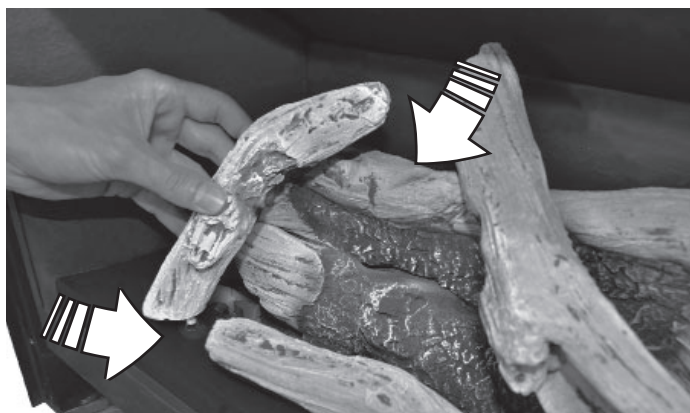

Re-install and Check Window

1. To refit the window, hook its top part to the firebox's opening frame. **Make sure that the wider part of the window frame is at the bottom. The top part is marked.**
2. While you hold it, push in and turn the two top spring-loaded bolts a quarter turn to engage their pin.
3. Push in the bottom of the window against the firebox and fasten the two bottom spring-loaded bolts a quarter turn.
4. **If the Hot Glass Warning plate has been removed from the front lower corner of the window, reinstall it by sliding it between the glass and the frame as indicated.**

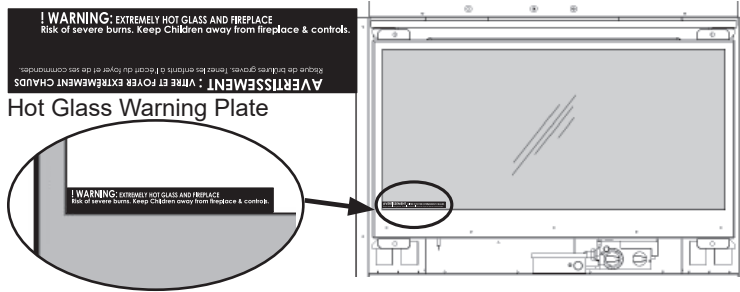
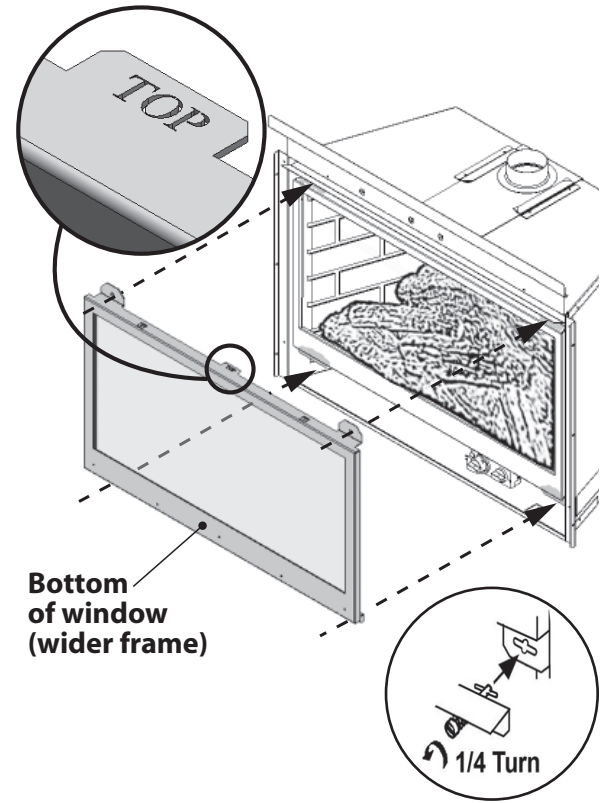

Install Battery Holder

The batteries that power the receiver need to be installed and placed prior to synchronization and use.

1. Remove the battery holder and cable from their packaging.



2. Insert high quality alkaline batteries in the battery holder (and remote handset).



3. Connect the cable to the receiver.
4. Connect the other end of the cable to the battery holder.

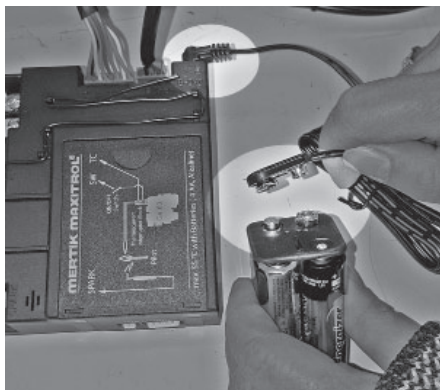

5. Place the receiver and battery holder as shown under the firebox, to the right of the control valve (placement may vary with installed options).

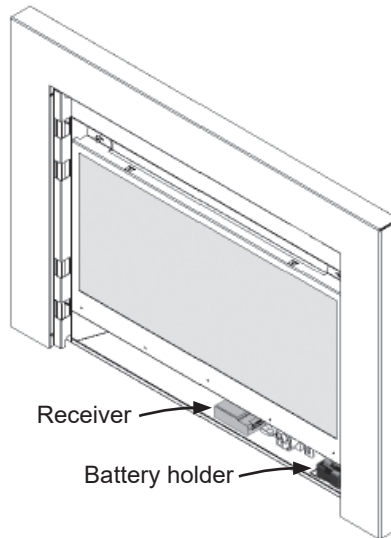

6. Use a heat resistant tie to gather any extra cable between the receiver and the holder.

CAUTION

DO NOT let the cable touch the burner plate above, it will melt during operation.

CAUTION

DO NOT PUT batteries in the receiver as they could leak and damage the receiver.

Installation

Synchronize Remote Control

The receiver and the handset of the remote control system must be initially synchronized before the first use.

1. With a thin object, press and hold the receiver's reset button until you hear one short and one long beep. Release the button after the second beep.



2. Within the subsequent 20 seconds, press the small flame button (♂) on the remote handset until you hear two short beeps confirming the synchronization is set.

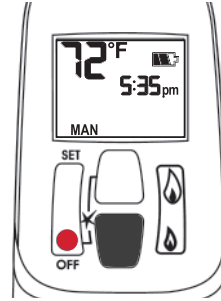

This is a one time setting only and is not required when changing the batteries in the remote handset. The remote control system is now ready to use.

Check Operation

Turn the fireplace flame up and down using the remote control to confirm that the full range of inputs is achieved—see the remote control operation instructions starting on page 9.

Adjust Aeration (if necessary)

Light the fire and allow the unit to warm up for 10–15 minutes to evaluate the flame picture. Burners are equipped with an adjustable shutter to control primary aeration. See the figures below. The shutters are factory-set to an aeration gap which will give optimum performance for the vast majority of installations.

Air Shutters

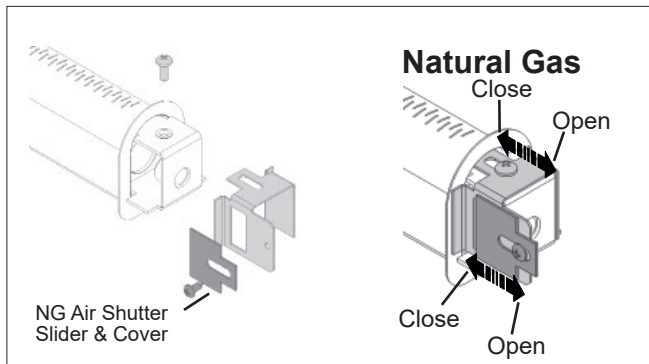

Depending of fuel bed used, altitude and other considerations, the flame picture may be improved by adjusting the aeration. The need for adjustment should be determined only by operating the appliance with the fuel bed, liners and window installed and evaluating the flame picture after a 15-minute warm-up.

Increasing aeration (open) will cause the flames to appear more transparent and blue showing more ceramic log glow.

Decreasing aeration (close) will cause the flames to appear more yellow or orange showing less ceramic log glow.

Too little aeration may result in black carbon forming and dropping into the firebox.

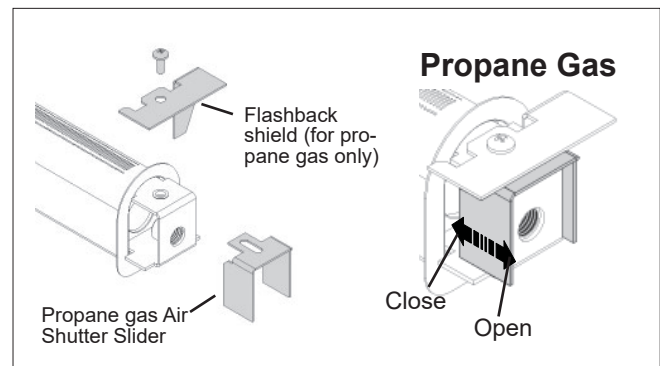

Installation

Install Front, Trim and Barrier Screen

Install the front and trim chosen by the customer for their fireplace. Install as well the barrier screen which is provided with the front.

Show the customer remove the front and also how to access the controls when the front is installed.

Follow the instructions provided with the front et trim and leave those instructions behind for the customer's further reference.

Install Handset Wall Holder

The remote control kit for this fireplace comes complete with a wall-mounted holder. This holder is not required in all installations but is provided as an optional feature for those customers who wish to mount the remote handset to the wall.

To install the holder to the wall, find a convenient location and use the hardware provided with the kit. See the diagram at right for required hardware and configurations. Note that the holder can be installed at the base of a light switch plate.

IMPORTANT. The location of the remote control handset is important to assure proper temperature regulation. To obtain a constant temperature, we recommend that the handset should be between 3 and 15 feet away from the appliance **but not directly above it**. We also advise that the handset should be located away from any other heat source and not in direct sunlight as this may affect the temperature sensor located in the remote handset.

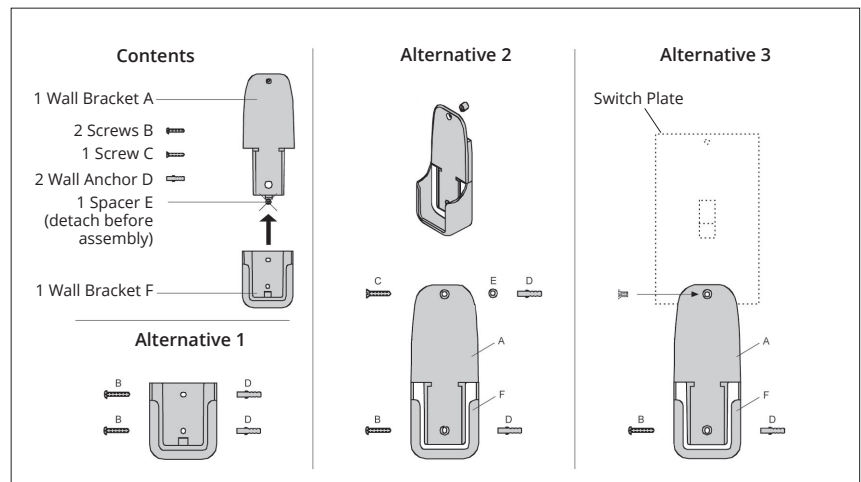

Wiring Diagram

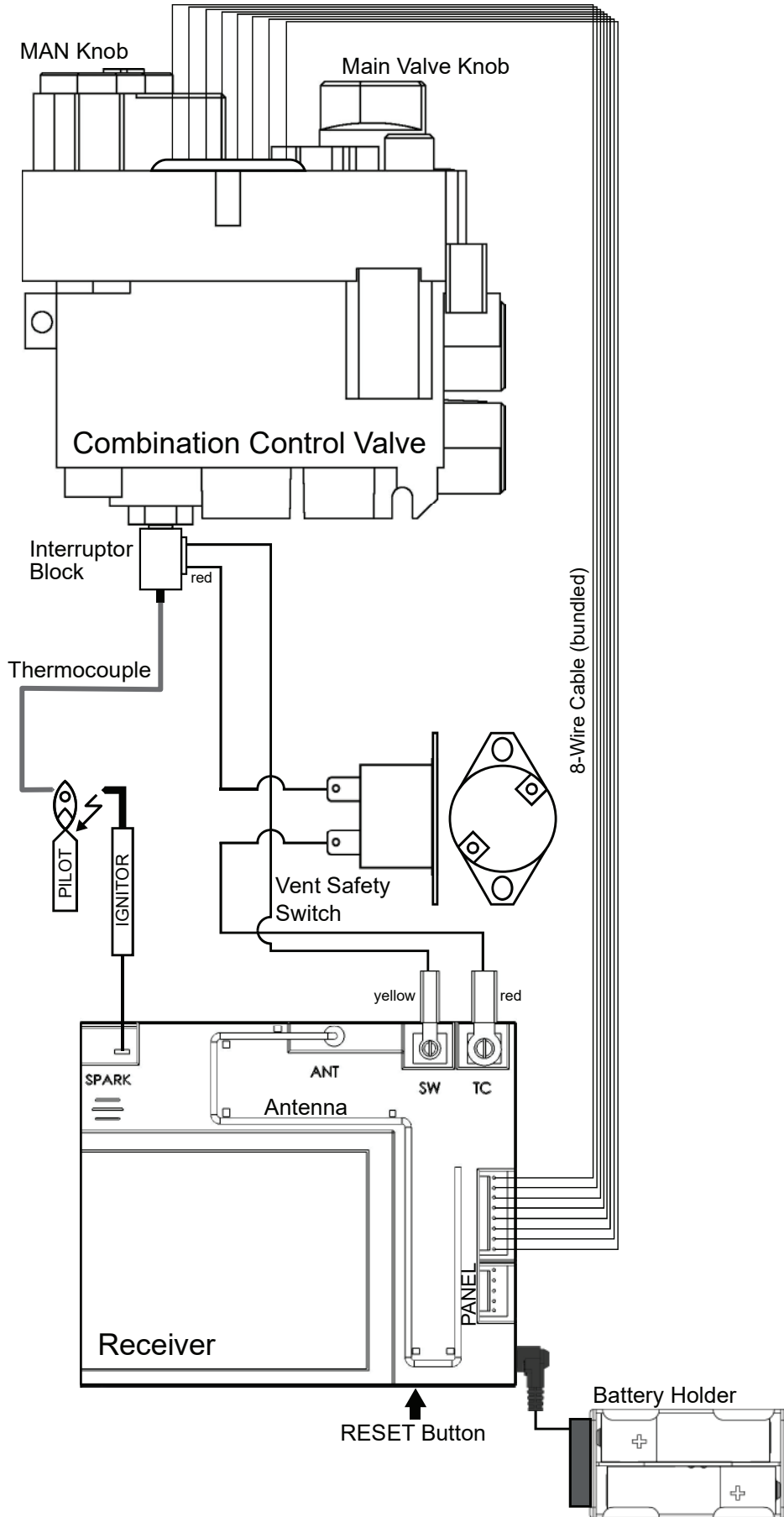

Warranty—Indoor Installations

If you have a problem with this unit, please contact your dealer or supplier immediately. Under no circumstances should you attempt to service the unit in any way by yourself. The warranties in paragraphs 1 and 2 are provided only to the initial user of this unit, are not transferable and are subject to the conditions and limitations in paragraphs 3, 4 and 5. Please review the conditions and limitations carefully and strictly follow their requirements.

1. Extended Warranty Coverage

For a period of up to ten (10) years, Miles Industries Ltd., (the "Company") or its appointed distributor will at its option pay the initial owner for the repair of, or will exchange the following parts or components which are found to be defective in material or workmanship under normal conditions of use and service:

Maximum Warranty Period		10 years
Part or Component	Defect Covered	
Exterior steel casing	Corrosion	✓
Glass	Loss of structural integrity	✓
Cast iron parts	Corrosion	✓
Firebox and heat exchanger	Corrosion (but not discoloration) causing loss of structural integrity	✓

2. Two-Year Parts Warranty

In addition, for two (2) years from the date of purchase, the Company, at its option, will repair or exchange all parts and components not listed above but that are found to have a bona fide defect in material or workmanship under normal conditions of use.

3. Conditions and Limitations

- The warranty registration card must be completed by the initial owner and returned to the company within 90 days. Alternatively, the warranty registration form may be filled out online at www.valorfireplaces.com
- Installation and maintenance must be performed by an authorized and trained dealer in accordance with the Company's installation instructions.
- This warranty is void where installation of the unit does not conform to all applicable codes including national and local gas appliance installation codes and building and fire codes.
- The owner must comply with all operating instructions.
- The Company is not responsible for the labor costs to remove defective parts or re-install repaired or replacement parts.
- The initial owner of the unit will be responsible for any shipping charges for replacement parts as well as travel time incurred by the dealer to perform the warranty work.

- This warranty applies to non-commercial use and service and is void if it is apparent that there is abuse, misuse, alteration, improper installation, accident or lack of maintenance to the unit.
- The warranty does not cover damage to the unit through:
 - Improper installation, operational or environmental conditions.
 - Inadequate ventilation in the area or competition for air from other household equipment or appliances.
 - Chemicals, dampness, condensation, or sulphur in the fuel supply lines which exceeds industry standards.
- This warranty does not cover glass, log breakage or damage to the unit while in transit.
- The Company does not allow anyone to extend, alter or modify this warranty and assumes no responsibility for direct, indirect or consequential damages caused by the unit. State or provincial laws where the initial user or user resides may provide specific rights extending this warranty and, if so, the Company's sole obligation under this warranty is to provide labor and/or materials in accordance with those laws.

4. Discharge of Liability

After two (2) years from the date of purchase, the Company may, at its option, fully discharge all obligations under this warranty by paying to the first owner the wholesale price of, or replacing, any defective parts.

5. No Other Warranty

All obligations to repair this unit are defined in this warranty. Some states or provinces may specifically mandate additional obligations on the part of manufacturers, but in the absence of such specific legislation, there is no other warranty or obligation expressed or implied.

Warranty—Outdoor Installations

If you have a problem with this unit, please contact your dealer or supplier immediately. Under no circumstances should you attempt to service the unit in any way by yourself. The warranties in paragraphs 1 are provided only to the initial owner of this unit, are not transferable and are subject to the conditions and limitations in paragraphs 2 and 3. Please review the conditions and limitations carefully and strictly follow their requirements.

1. Two-Year Parts Warranty

Two (2) years from the date of purchase, the Company, at its option, will repair or exchange all parts and components that are found to have a bona fide defect in material or workmanship under normal conditions of use.

2. Conditions and Limitations

- a) The warranty registration card must be completed by the initial owner and returned to the company within 90 days. Alternatively, the warranty registration form may be filled out online at valorfireplaces.com
- b) Installation and maintenance must be performed by an authorized and trained dealer in accordance with the Company's installation instructions.
- c) This warranty is void where installation of the unit does not conform to all applicable codes, including national and local gas appliance installation codes and building and fire codes.
- d) The owner must comply with all operating instructions.
- e) The Company is not responsible for the labor costs to remove defective parts or re-install repaired or replacement parts.
- f) The initial owner of the unit will be responsible for any shipping charges for replacement parts as well as travel time incurred by the dealer to perform the warranty work.
- g) This warranty applies to non-commercial use and service and is void if it is apparent that there is abuse, misuse, alteration, improper installation, accident or lack of maintenance to the unit.
- h) This warranty does not cover damage to the unit due to:
 - i) Improper installation, operational or environmental conditions.
 - ii) Inadequate ventilation in the area or competition for air from other household equipment or appliances.
 - iii) Damage due to chemicals, dampness, condensation, or sulphur in the fuel supply lines which exceeds industry standards.
- i) This warranty does not cover glass, log breakage or damage to the unit while in transit.
- j) The Company does not allow anyone to extend, alter or modify this warranty and assumes no responsibility for direct, indirect or consequential damages caused by the unit. State or provincial laws where the initial owner or user resides may provide specific rights extending this warranty and, if so, the Company's sole obligation under this warranty is to provide labor and/or materials in accordance with those laws.

3. No Other Warranty

All obligations to repair this unit are defined in this warranty. Some states or provinces may specifically mandate additional obligations on the part of manufacturers, but in the absence of such specific legislation, there is no other warranty or obligation expressed or implied.

Spare Parts

Code	Description	Part Number
1	Exhaust Slide Assembly	4000127
2	Port Cover	4001820AH
3	Fuel Bed Support	4006177
4	Side Bricks Anchors (2)	4001283
5	Top Mounting Bracket	4000136AZ
6	Side Mounting Brackets (2)	4000135AZ
7	Window Assembly	4001378
7a	Hot glass warning plate	4003093
8	Burner Assembly (natural gas)	4007450
	Burner Assembly (propane gas)	4007451
9	Burner Rail (natural gas)	4001665
	Burner Rail (propane gas)	4001666
10	Injector Elbow (natural gas)	9730012
	Injector Elbow (propane gas)	9730007
11	Air Shutter Cover (natural gas)	4002346
11a	Air Shutter Slider (natural gas)	4002345
12	Flashback Shield (propane gas)	3000371
12a	Air Shutter Slider (propane gas)	320B293
13	Burner Baffle	4001784
14	Burner Mounts (2)	4001678
15	Pilot Shield	4000144
16	Pilot Assembly (natural gas)	4007220S
	Pilot Assembly (propane gas)	4007221S
17	Pilot Bracket	720A542
18	Pilot Injector #35 (natural gas)	4002511
	Pilot Injector #27 (propane gas)	720A195
19	Hooked Olive for Pilot Injector	720A196
20	Olive Nut for Pilot Pipe	420K385
21	Electrode	4001856
22	Electrode Retaining Nut	4001855
23	Thermocouple	4000061
24	Pilot Mount	4000138
25	Pipe—Valve to Main Burner (incl. olive & nuts)	4000065
26	Burner Tray	4001677
27	Burner Plate Access Panel	4001681
28	Olive Nut for Pilot Pipe	220K913
29	Pipe—Valve to Pilot	4001838
30	Valve Mounting Bracket	4000141
32	Thermocurrent Interruptor	4001037

Code	Description	Part Number
33	GV60 Valve Assembly (natural gas)	4007440X
	GV60 Valve Assembly (propane gas)	4007441X
35	Cable interrupter-receiver (yellow)	4002096
36	Ignition Cable 500 mm	4001039
37	Ignition Cable Sleeve	4002244
38	Receiver PLUS	4001911
39	Wiring Harness	4001187
40	Vent Safety Switch Assembly	4007429
41	Handset PLUS	4001910
42	Handset Wall Holder	9000008
43	GV60 Valve Repair Kit	4004544
44	Traditional Log Set Complete	739LSK
45	Rear Log	4003787
46	LH Top Log	4003788
47	RH Top Log	4003789
48	RH Center Log	4003790
49	LH Front Log	4003792
50	RH Front Log	4003793
51	Loose Coals	4001843
52	Liner Set Complete	
	Fluted Black	739FBL
	Valor Red Brick	739VRL
	Reflective Glass	739RGL
53	Rear Panel	
	Fluted Black	4001814
	Valor Red Brick	4001811
	Reflective Glass	4005017
54	Left Panel	
	Fluted Black	4001812
	Valor Red Brick	4001809
	Reflective Glass	4005015
	Filler Panel	4005018
55	Right Panel	
	Fluted Black	4001813
	Valor Red Brick	4001810
	Reflective Glass	4005016

Spare Parts

Code	Description	Part Number
56	Rock Set Complete	739RSK
57	Rock No. 1	4001821
58	Rock No. 2	4001822
59	Rock No. 3	4001823
60	Rock No. 4	4001824
61	Rock No. 5	4001825
62	Rock No. 6	4001826
63	Rock Base	4001792
64	LH Twig	4001827
65	RH Twig	4001828
66	Glass Panel	4001836
67	Front Support—Platform	4001835BY
68	Ceramic Platform	4001832
69	Driftwood Kit	739DWK
70	Rear Log	4005615
71	Base Log	4005617
72	RH Cross Log	4005616
73	Front Log	4005819
74	LH Cross Log	4005618
75	Small Beige Beach Pebble (3)	4003087
76	Small Grey Beach Pebble	4003086
77	Brown Beach Pebble	4003082
78	Grey Beach Pebble	4003083
79	Platform	4005619
80	Auxiliary battery holder	4006553
81	Battery holder cable 1500 mm	4006552
82	2.5-4.5" hose clamp	4000768

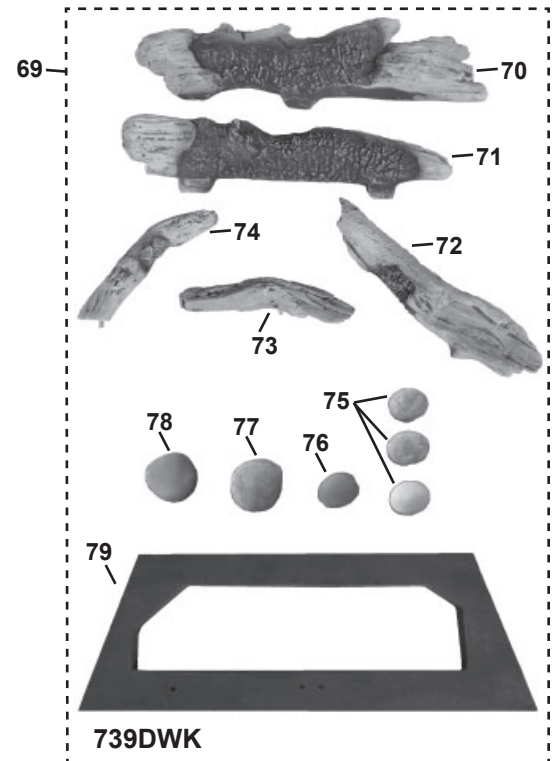
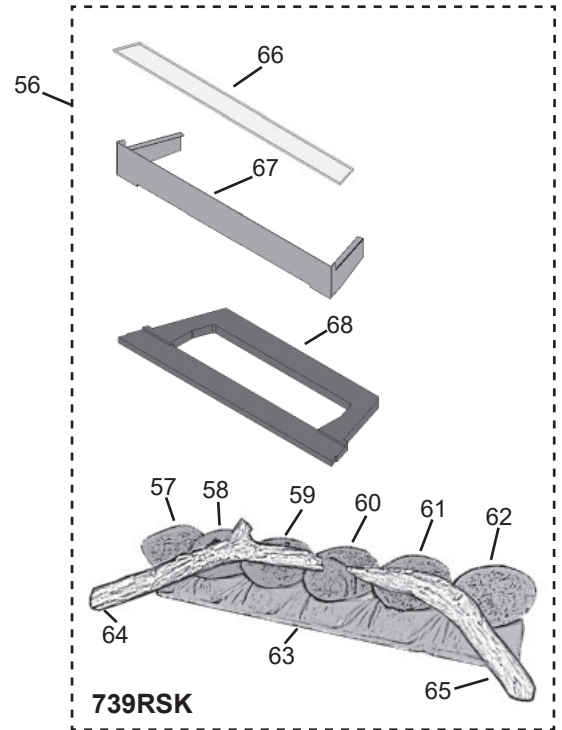

Spare Parts

