

valor® L1 1500K

December 2019
1/4

Co-Linear Venting—existing fireplace cavity

Installation Into Existing Fireplace Cavity

Co-linear portion of vent system may only be installed within a solid-fuel burning fireplace and chimney.

The appliance must not be connected to a chimney flue serving a separate solid-fuel burning appliance.

Requires the Valor Co-Axial to Co-Linear appliance Adapter 1156CLA, two lengths of 2-ply 3" dia. flexible chimney liner approved for venting gas appliances, a co-linear termination kit and flashing or a co-linear to co-axial adapter and either a high wind vertical vent terminal cap or a low profile vertical termination.

Firebox zero clearance standoffs supplied with the heater are not required for this application.

Rules for Co-Linear Venting

- Maximum 40 feet vertical pipe
- Minimum 10 feet vertical
- Maximum offset 8 feet with liners at minimum 45 degrees from horizontal plane
- Restrictor: Not required when using co-linear venting.

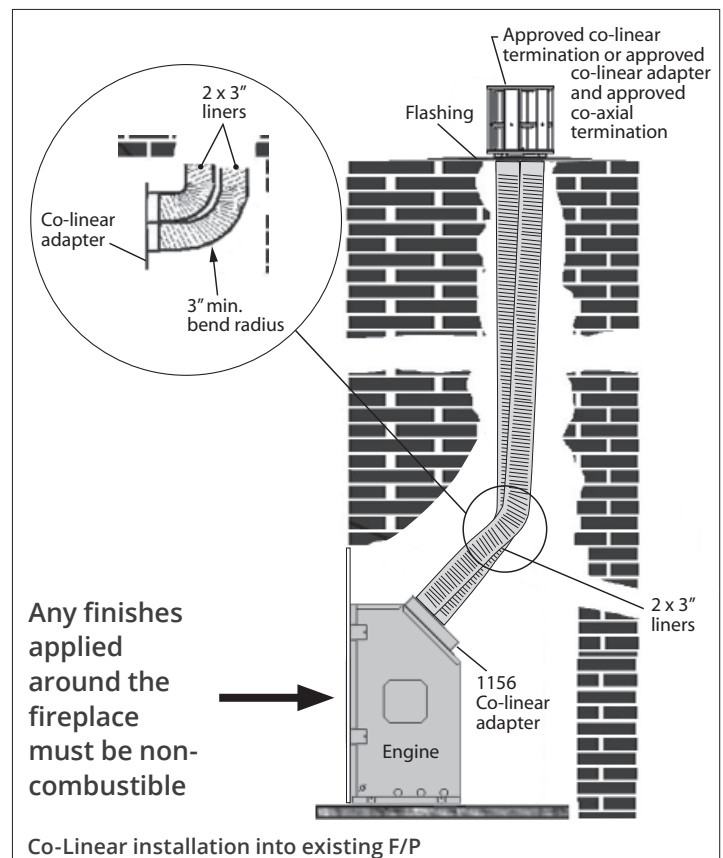
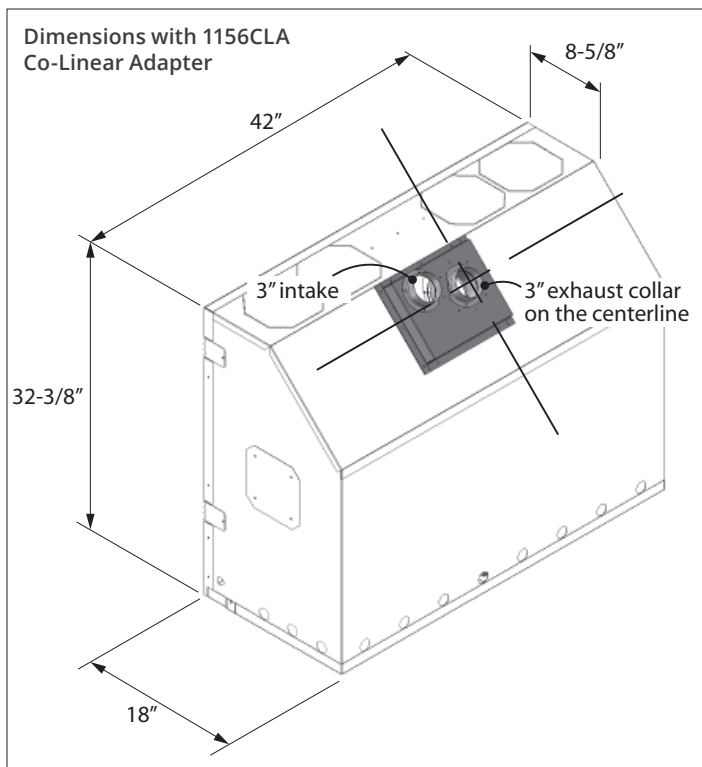
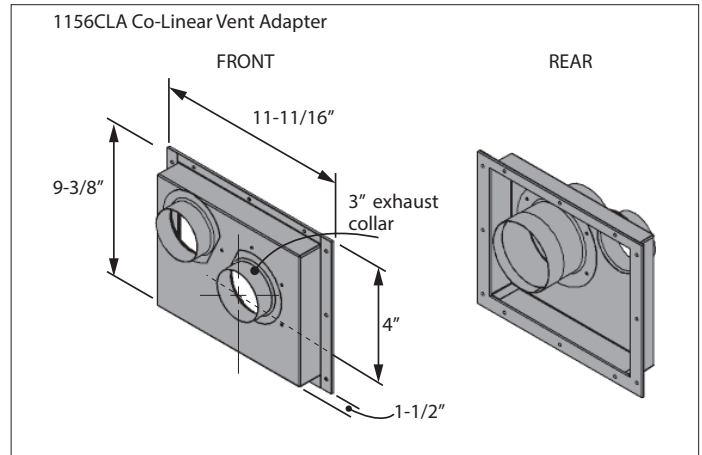

valor® L1 1500K

December 2019
2/4

Co-Linear Venting partially into existing cavity

Installation Partially Into Fireplace Cavity

Note: Co-linear portion of vent system may only be installed within a solid-fuel burning fireplace and chimney.

The appliance can be adapted to co-linear applications using an existing chimney. The appliance must not be connected to a chimney flue serving a separate solid-fuel burning appliance.

Requires the Valor Co-Axial to Co-Linear appliance Adapter 1156CLA, 46DVA-GCL or equivalent, two lengths of 2-ply 3" diameter flexible chimney liner approved for venting gas appliances, a co-linear termination kit, and flashing or a co-linear to co-axial adapter and either a high wind vertical vent terminal cap or a low profile vertical termination.

The appliance must be fully enclosed while maintaining clearances to combustibles detailed elsewhere in this manual.

Rules for Co-Linear Venting

- Maximum 40 feet vertical pipe
- Minimum 10 feet vertical
- Maximum offset 8 feet with liners at minimum 45 degrees from horizontal plane
- Restrictor: Not required when using co-linear venting.

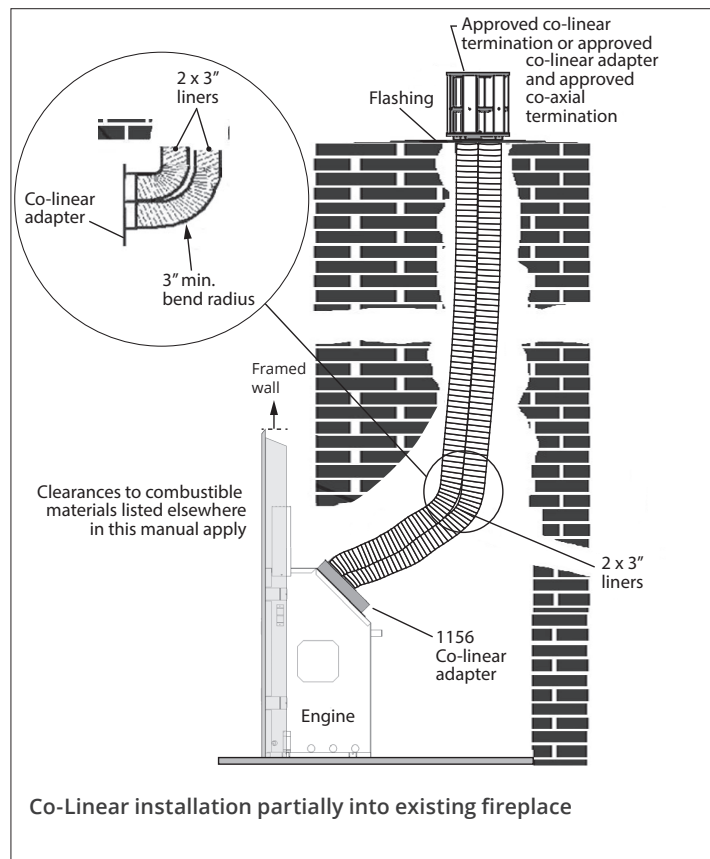

valor® L1 1500K

December 2019
3/4

Co-Linear Venting into existing adjacent chimney

Installation Into Existing Adjacent Chimney

Note: Co-linear portion of vent system may only be installed within a solid-fuel burning fireplace and chimney.

The appliance can be adapted to co-linear applications using an existing chimney. The appliance must not be connected to a chimney flue serving a separate solid-fuel burning appliance.

Requires the Co-Axial to Co-Linear appliance Adapter 46DVA-CLAA, 46DVA-GCL, or equivalent, two lengths of 3", 2-ply flexible chimney liner both approved for

venting gas appliances, a co-linear termination kit, and flashing.

The appliance must be fully enclosed while maintaining clearances to combustibles detailed elsewhere in this manual.

Rules for Co-Linear Venting

- Maximum 40 feet vertical pipe
- Minimum 10 feet vertical
- Maximum offset 8 feet with liners at minimum 45 degrees from horizontal plane
- Restrictor: Not required when using co-linear venting.

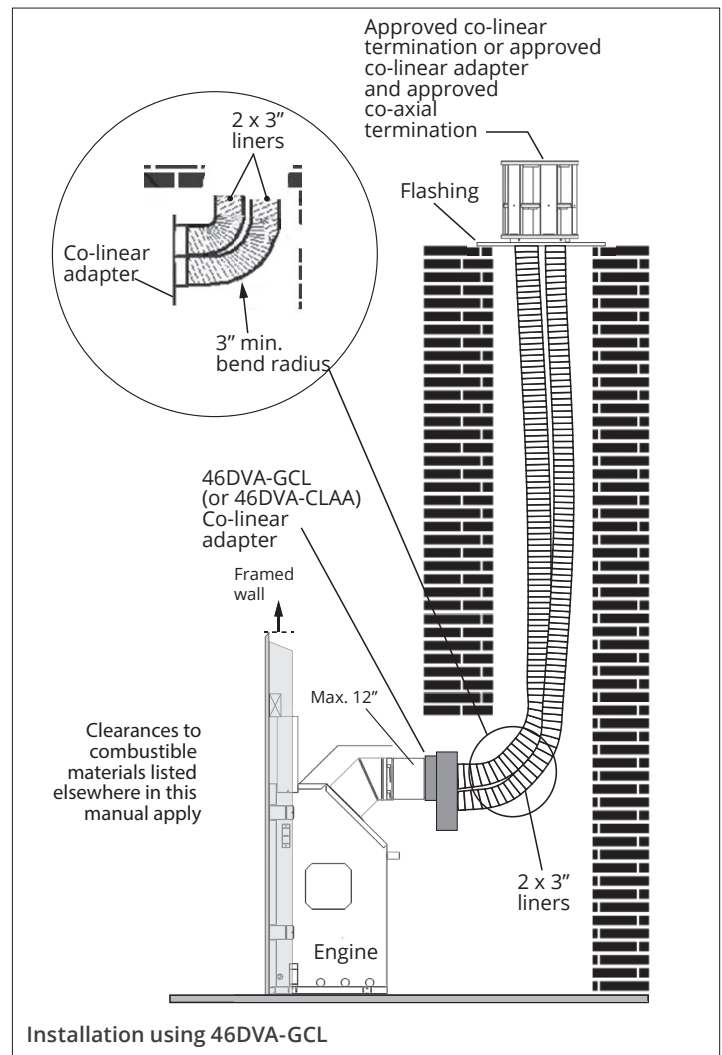
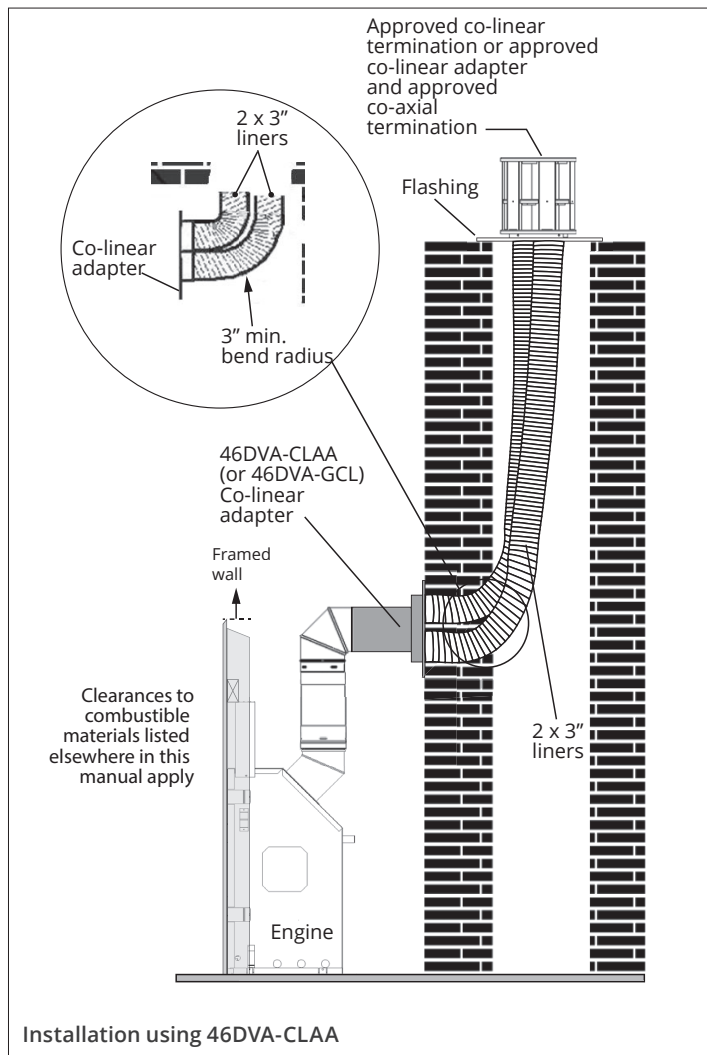

valor® L1 1500K

December 2019
4/4

Co-Linear Venting—Example of accessories

Co-axial to Co-linear Appliance Adapters

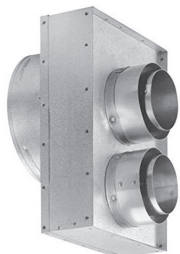

46DVA-GCL



46DVA-CLAA

Note: Co-linear flexible aluminum venting should be professionally inspected periodically for corrosion and damage and replaced when necessary. If the installation does not allow for future inspection or replacement of the flexible aluminum venting, then stainless steel vent liners should be used.

Co-linear Terminal Configurations

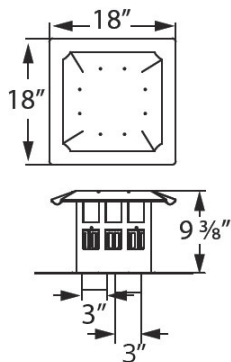
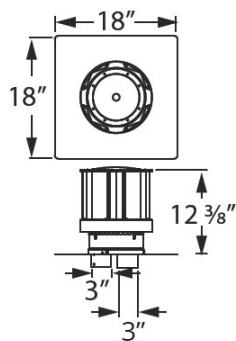
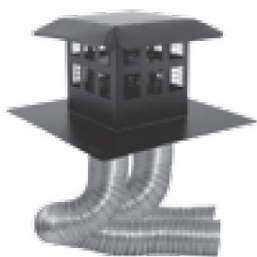

Co-linear Termination Kits

Alternate Co-linear to Co-axial Conversion at Terminal

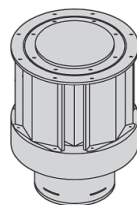

With...

Co-axial Terminal Cap

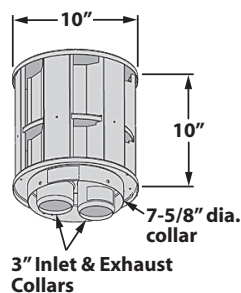
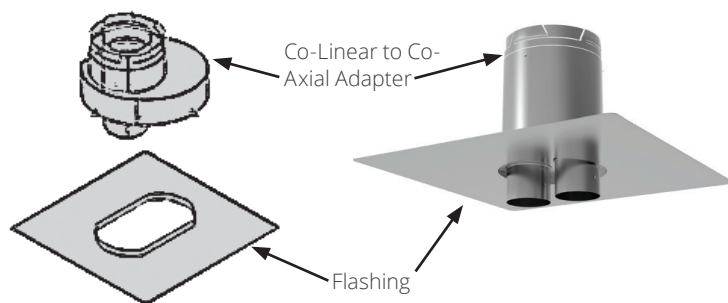

Co-linear Terminal (typical)

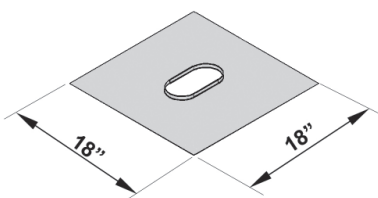

Flashing Kit