

Installation Manual



G4

Direct Vent Gas Fireplace Insert
Gas Fireplace
natural gas 785YN
propane gas 785YP

with
AutoFire™

Canadian Patent 2,717,779 Issued October 24 2017
US Patent 10,060,624 Issued August 28 2018
US Patent 10,935,246 Issued March 2 2021

Installer: Place model/serial number here.

Installer: Leave this manual with the appliance.
Consumer: Retain this manual for future reference.

⚠ WARNING:
FIRE OR EXPLOSION HAZARD
Failure to follow safety warnings exactly could result in serious injury, death, or property damage.

Do not store or use gasoline or other flammable vapors and liquids in the vicinity of this or any other appliance.

WHAT TO DO IF YOU SMELL GAS

- Do not try to light any appliance.

- Do not touch any electrical switch; do not use any phone in your building.
- Leave the building immediately.
- Immediately call your gas supplier from a neighbor's phone. Follow the gas supplier's instructions.
- If you cannot reach your gas supplier, call the fire department.

Installation and service must be performed by a qualified installer, service agency or the gas supplier.

⚠ DANGER



Hot glass will cause burns.

Do not touch glass until cooled.

Never allow children to touch glass.

A barrier designed to reduce the risk of burns from the hot viewing glass is provided with this appliance and must be installed for the protection of children and other at-risk individuals.

This appliance may be installed in an after-market permanently located, manufactured (mobile) home where not prohibited by local codes. This appliance is only for use with the type of gas indicated on the rating plate. This appliance is not convertible for use with other gases, unless a certified kit is used.

INSTALLER: Leave this manual with the appliance.
CONSUMER: Retain this manual for future reference.

Massachusetts:

The piping and final gas connection must be performed by a licensed plumber or gas fitter in the State of Massachusetts.

⚠ WARNING

This product can expose you to chemicals including Benzene, which is known to the State of California to cause cancer and birth defects or other reproductive harm. For more information go to www.P65Warnings.ca.gov.

Note: Natural gas, in its original state, contains Benzene.

This appliance is a domestic room-heating appliance. It must not be used for any other purposes such as drying clothes, etc.

This appliance is suitable for installation in a bedroom or bed sitting room.

Ce guide est disponible en français sur demande.



We recommend a US Certified National Fireplace Institute (NFI) specialist install our gas hearth products.



The information contained in this manual is believed to be correct at the time of printing. Miles Industries Ltd. reserves the right to change or modify any information or specifications without notice. Miles Industries Ltd. grants no warranty, implied or stated, for the installation or maintenance of your heater, and assumes no responsibility for any consequential damage(s).

© Copyright Miles Industries Ltd., 2024. All rights reserved.
Designed and manufactured for Miles Industries Ltd.

Welcome to Valor®

This appliance has been professionally installed by:

Dealer Name: _____

Phone: _____

Please read this manual BEFORE installing and operating this appliance.

Fireplace Safety	4
Specifications	6
Kits & Accessories.....	7
Dimensions.....	8
Clearances	9
Installation Planning.....	11
Before Installation	11
Overview	12
Venting	13
Overview	13
Installation Preparation	14
Existing Fireplace Preparation	14
Remove Window	15
Install Fan Kit (if used)	15
Installation	16
Connect Venting.....	16
Gas Supply.....	17
Liner Panels	20
Fuel Beds	21
Driftwood 1101DWK	21
Decorative Glass Murano 785XDGM	23
Install Window.....	24
Remote Control Pairing.....	25
Check Operation and Aeration.....	26
Front/Trim.....	27
Handset Wall Holder	28
Wiring Diagram.....	29
Approved Venting Components	30
Appendix A-Lighting Instructions Plate.....	31
Appendix B-Remote Control Operation	32
Appendix C-Spare Parts	36

Fireplace Safety

This manual contains very important information about the safe installation and operation of the fireplace. Read and understand all instructions carefully before installing and operating the fireplace. Failure to follow these instructions may result in possible fire hazard and will void the warranty.

Replacement manuals are available by contacting the Valor Customer Service at 1-800-468-2567, or by visiting valorfireplaces.com.

WARNING: Extremely Hot!

Heat and flammability

- Some parts of the fireplace are extremely hot, particularly the glass window. Use the barrier screen provided or a gate to reduce the risk of severe burns.
- The glass windows can exceed 500°F at full capacity.
- Always keep the appliance clear and free from combustible materials, gasoline, and other flammable vapors and liquids.
- Be aware of hot wall surfaces! The wall directly above the fireplace can get very hot when the fireplace heats. Although safe, it may reach temperatures in excess of 200°F (93°C) depending on choice of optional accessories. Do not touch!
- Be aware of hot shelf/hearth/floor surfaces! Any projections directly around the fireplace can get very hot when the fireplace heats. Although safe, they may reach temperatures in excess of 200°F (93°C) depending on their elevation. Be careful of touching these! Do not put objects on the hearth or shelf. Temperature of projection surfaces will be reduced when barrier screens are installed.
- Some materials or items, although safe, may discolor, shrink, warp, crack, peel, and so on because of the heat produced by the fireplace. Avoid placing candles, paintings, photos and other combustible objects sensitive to heat or furniture within 36 inches (0.9 m) around the fireplace.
- Solid wood flooring in front of the fireplace (if allowed) may shrink during the heating season due to heat.
- Due to high temperatures, the appliance should be located out of traffic areas and away from furniture and draperies.
- Clothing or other flammable material should not be placed on or near the appliance.

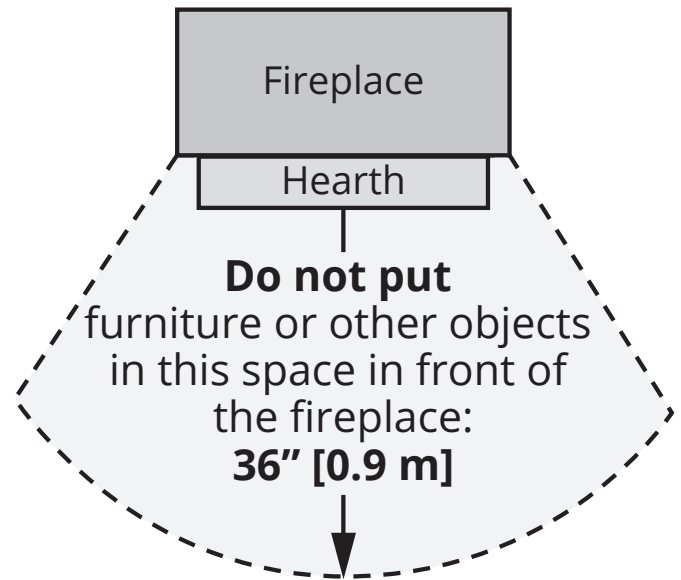

Barrier Screen and Safety

- A barrier designed to reduce the risk of burns from the hot viewing glass is provided with this appliance and must be installed for the protection of children and other at-risk individuals.
- Children and adults should be alerted to the hazards of high surface temperature and should stay away to avoid burns or clothing ignition.
- Young children should be carefully supervised when they are in the same room as the appliance. Toddlers, young children, and others may be susceptible to accidental contact burns. A physical barrier is recommended if there are at-risk individuals in the house. To restrict access to a fireplace or stove, install an adjustable safety gate to keep toddlers, young children, and other at-risk individuals out of the room and away from hot surfaces.
- Any safety screen, guard, or barrier removed for servicing an appliance, must be replaced prior to operating the appliance.

Fireplace Safety

Glass window



WARNING

Do not operate this appliance with the glass front removed, cracked, or broken.

Do not strike or slam the glass front.

Replacement of the glass front should be performed by a licensed or qualified service person.

- The glass front assembly must be in place and sealed before the unit can be placed into safe operation.
- The glass front assembly must only be replaced as a complete unit, as supplied by the fireplace manufacturer. No substitute material may be used.
- Do not use abrasive cleaners on the glass front assembly. Do not attempt to clean the glass when it is hot.

Venting

- This unit must be used with a vent system as described in this manual. No other vent system or components may be used.
- Never obstruct the flow of combustion and ventilation air. Keep the front of the appliance clear of all obstacles and materials for servicing and proper operation.
- This gas fireplace and vent assembly must be vented directly to the outside and must never be attached to a chimney serving a separate solid fuel burning appliance. Each gas appliance must use a separate vent system. Common vent systems are prohibited.

Intended use

- This appliance is designed and approved as a supplemental heater and provides the potential for most energy conservation when used while attended. The use of an alternate primary heat source is advisable.
- This unit is not for use with solid fuel.
- Do not use this heater as a temporary source of heat during construction.

Installation and Servicing

- Installation and repair should be done by a qualified service person. The appliance should be inspected before use and at least annually by a professional service person. More frequent cleaning might be required due to excessive lint from carpeting, bedding material, et cetera. It is imperative that control compartments, burners, and circulating air passageways of the appliance be kept clean.
- Do not use this appliance if any part has been under water. Immediately call a qualified service technician to inspect the appliance and to replace any part of the control system and any gas control that has been under water.

Specifications

Approval & Codes

This appliance is certified to ANSI Z21.88/CSA 2.33 American National Standard / CSA Standard for Vented Gas Fireplace Heaters for use in Canada and USA, and to CGA 2.17-91 High Altitude Standard in Canada. This appliance is for direct vent installations.

This appliance complies with CSA P.4.1-15 Testing method for measuring annual fireplace efficiencies.

The installation must conform to local codes or, in the absence of local codes, with the National Fuel Gas Code, ANSI Z223.1/NFPA 54 or the Natural Gas and Propane Installation Code CAN/CGA-B149.1. Only qualified licensed or trained personnel should install this appliance.

This appliance must be electrically grounded in accordance with local codes, or, in the absence of local codes, with the National Electrical Code, ANSI/NFPA 70 or the Canadian Electrical Code, CSA C22.1.

Ratings

Model	785YN	785YP
Gas	Natural	Propane
Altitude (Ft.)*	0-4,500 feet*	
Input Maximum (Btu/h)	28,000	26,000
Input Minimum (Btu/h)	15,000	13,000
Manifold Pressure (in w.c.)	3.2"	9.5"
Minimum Supply Pressure (in w.c.)	5"	11"
Maximum Supply Pressure (in w.c.)	10"	14"
Main Burner Injector Marking	850	300
Pilot Injector Marking	51	30
Min. Rate By-Pass Screw	190	125

*High Altitude Installations

Input ratings are shown in BTU per hour and are certified without deration for elevations up to 4,500 feet (1,370 m) above sea level.

For elevations above 4,500 feet (1,370 m) in USA, installations must be in accordance with the current ANSI Z223.1 and/or local codes having jurisdiction. Heating value of gas in some areas is reduced to compensate for elevation—consult your local gas utility to confirm.

For installations at elevations above 4,500 feet (1,370 m) in Canada, please consult provincial and/or local authorities having jurisdiction.

Supply Gas

Heater engine 785YN is used with natural gas.

Heater engine 785YP is used with propane gas.

The supply pressure must be between the limits shown in the Ratings section.

The supply connection is 1/2" NPT female and located on the left side of the control valve. The gas line entry point is on the the upper left hand side of the fireplace. See *Gas Supply* pages 17–19 for connection details.

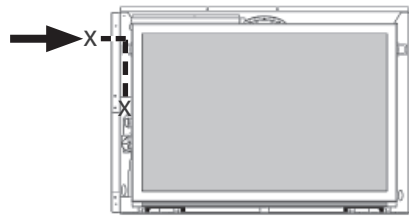

Electrical

The 785 G4 is designed to run on battery power and does not require an electrical source to operate as a heater. However, if the appliance is fitted with a fan, a grounded power source is required.

Conversion Kits

The 785 is supplied as natural gas or propane gas and is field convertible between fuels. See instructions packaged with the conversion kits for further information.

Floor/Hearth

This appliance is approved for installation into existing solid-fuel burning fireplaces only. Combustible material such as plywood and so on may be used for leveling and shimming beneath the unit. This appliance does not require a hearth other than to support the weight of certain fronts.

Note: This appliance is designed and approved as a supplemental heater and provides the potential for most energy conservation when used while attended. The use of an alternate primary heat source is advisable.

Kits & Accessories

Required Kits

Fuel Beds (choose one)		
1101DWK	Driftwood Log Set	
785XDGM	Decorative Glass Murano	
Liners (choose one)		
786LSLV3	Ledgestone Panels	
787RGL	Reflective Glass Panels	
788FBLV2	Fluted Black Panels	
789VRLV2	Valor Red Brick Panels	
Fronts (choose one)		Barrier Screen
784EC	Edgemont Craftsman Fronts	4007655AZ
784ECBR	Bronze	
784ECPW	Pewter	
784ECCB	Champagne Brass	
790FTV	Floating Trim vintage iron	4003371AZ
791	Square Trim Kits	4003371AZ
791STB	Black	
791STV	Vintage iron	
791STP	Polished	
792	Floating Trim Kits	4003371AZ
792FTB	Black	
792FTV	Vintage iron	
792FTZ	Bronze	
798	Floating 4-Sided Trims	4003371AZ
798FFB	Black	
798FFV	Vintage iron	
798FFZ	Bronze	
799ED	Edgemont Door Kits	4004348AZ
799EDFZ	Bronze	
799EDFN	Nickel	
Backing Plates for 784EC and 799ED fronts (choose one)		
799BPB-1 799BPB-2 799BPB-3	3-Sided flat Backing plates, black	
799STB-1 799STB-2	3-Sided square Backing plates, black	
799BPB-4S	4-Sided flat Backing plate, black	

Optional Accessories

Optional Backing Plates	
794BPB 794BPB-1	Backing plates Black for 790, 791 & 792
Gas Conversion Kits	
785YNGK	Conversion Kit to Natural Gas
785YPGK	Conversion Kit to Propane Gas
Other Accessories	
793RTB	Riser trim black for 790, 791, 792 & 798
793RTV	Riser trim vintage iron for 790, 791, 792 & 798
785RGP	Reflective Glass Panel for 788FBLV2
795CFKV2	Circulating Fan Kit
796ALP	Adjustable Leveling Platform
1265WSK	Wall Switch Kit
RBWSK	Remote Battery & Wall Switch Kit
Hearth Gate	Hearth gates such as Cardinal's VersaGate are available at retail stores carrying safety products for children.

Above information accurate at the time of printing and subject to change without notice.

Dimensions

Fireplace Dimensions

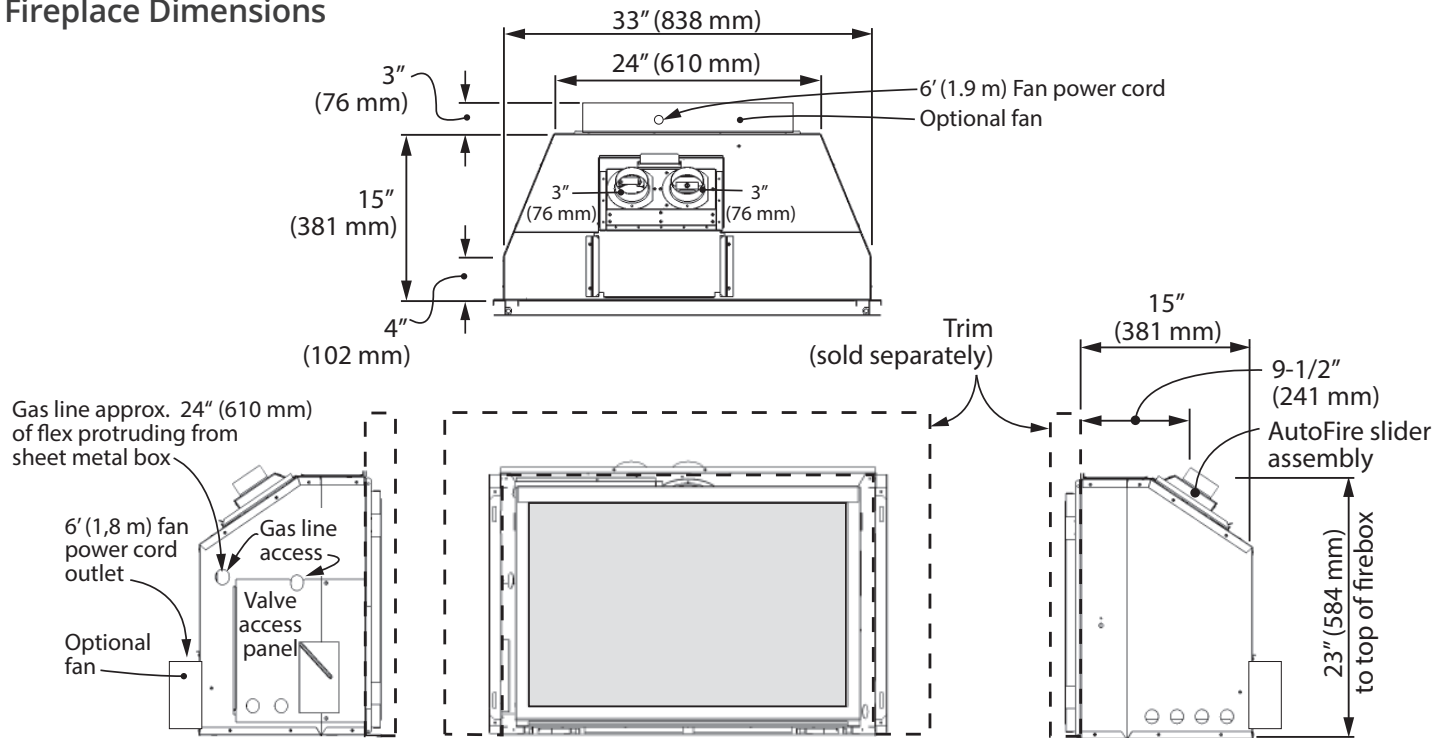

Cavity Dimensions

Check that masonry step does not interfere with install dimensions or vent pipe. If mantel is combustible, see following table for allowable clearances. A hearth that is at a height within 4" (102 mm) of the bottom of the heater **MUST** be non-combustible.

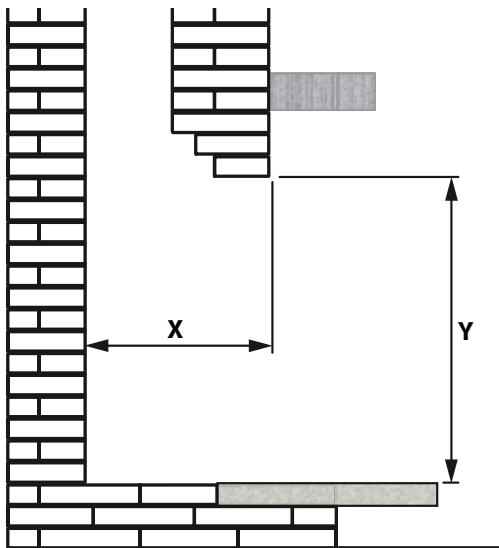

		Minimum Cavity Dimensions			
		All trims EXCEPT: 799ED or 784EC Edgemont Doors	799ED or 784EC Edgemont Doors		
		Standard Install	w/796 Leveling Platform	w/799BPB Flat Backing Plates	w/799STB Square Backing Plates
Width (min. fireplace opening at front)		33-1/4" [855 mm]	33-1/4" [855 mm]	35-3/4" [908 mm]	33-1/4" [855 mm]
Depth X	No Fan	15-1/2" [855 mm]	16" [406 mm]	16-3/4" [426 mm]	15-1/2" [855 mm]
	w/795 Fan	18-1/2" [470 mm]	18-1/2" [470 mm]	19-3/4" [502 mm]	18-1/2" [470 mm]
Height Y *		23-1/4" [591 mm]	23-1/4" [591 mm]	23-3/4" [603 mm]	23-3/4" [603 mm]

* Please note that the 799BPB-4S 4-Sided backing plate extends below the bottom of appliance by 2-13/16" (72 mm). Plan accordingly!

Clearances

Combustible Mantel Clearances

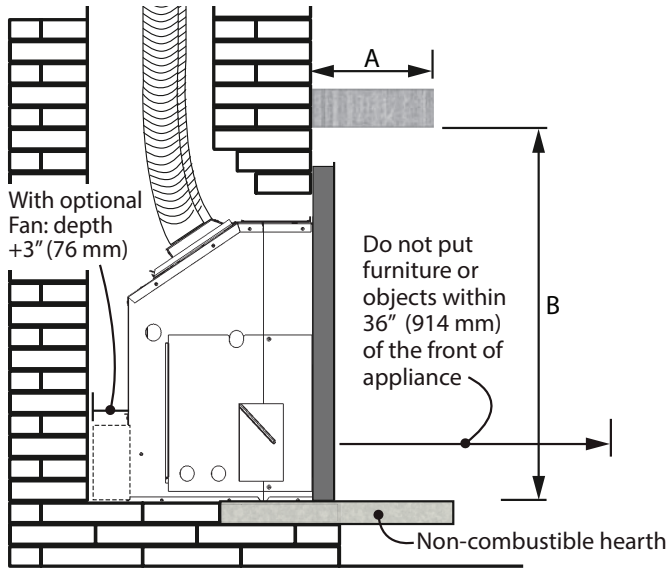

Clearances based on diagram above in Inches [mm]

Mantel Projection A	1 [25]	4 [101]	8 [203]	14 [355]
Mantel Projection B*	34 [864]	36 [914]	38 [965]	40 [1016]

* Measure taken from the underside of the mantel to finished hearth or surface that the unit is sitting on.

Finishing Materials

Combustible Materials: Materials made of or surfaced with wood, compressed paper, plant fibers, plastics, or other material that can ignite and burn, whether flame proofed or not, or plastered or unplastered.

Non-Combustible Materials: Material which will not ignite and burn. Such materials are those consisting entirely of steel, iron, brick, tile, concrete, slate, glass or plasters, or any combination thereof.

Materials that are reported as passing ASTM E 136, Standard Test Method for Behavior of Materials in a Vertical Tube Furnace at 750 °C.

WARNING

Some materials or items, although safe, may discolor, shrink, warp, crack, peel, and so on because of the heat produced by the fireplace. Avoid placing candles, paintings, photos, and other items sensitive to heat around the fireplace.

WARNING

HOT GLASS! The use of a screen in front of the glass is highly recommended, particularly in households with children

WARNING

HOT HEARTH/FLOOR! The hearth or floor in front of the fireplace may become very hot when the fireplace heats. Do not use the hearth as a seat or shelf. Solid wood flooring in front of the fireplace (if allowed) may shrink during the heating season due to heat.

Clearances

Clearances to Sidewall

Sidewall Clearances

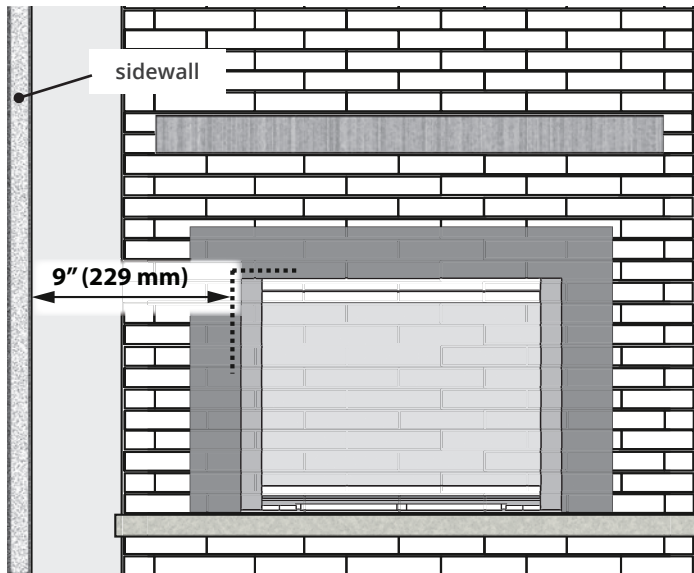

Minimum distance from side of appliance (liner box) to combustible wall: 9" [229 mm] (see above).

Mantel legs projecting forward less than 6" [152 mm] may be located within 5" [127 mm] of the side of the appliance (liner box).

Floor/ Hearth Clearances

Combustible shims/supports may be used beneath the appliance to level or raise the appliance within the existing fireplace cavity.

Combustible flooring/hearths in front of the appliance must be at a minimum of 4" [102 mm] below the bottom of the appliance. The gas insert does not require a hearth.

Installation Planning

Before Installation



Caution

Only qualified, license, or trained personnel should install this appliance.

Before Installation

1. YOU NEED TO KNOW FROM THE HOMEOWNER:
 - Whether any facing material will be used over the existing fireplace.
 - What trim, front, and optional accessories (if any) will be installed with this unit.
2. Unpack the appliance and recycle the packaging.
3. Check that you have everything, using the Pack Content sheet. Also, check that you have:
 - A fuel bed (packed separately)
 - Liner panels (packed separately)
 - Venting accessories
 - Electrical accessories (if using a fan kit)
 - Any other ordered accessories
4. Carefully read the Installers Checklist included with the fireplace for the installation sequence.



Note

The following steps must be done **BEFORE** the appliance is placed in its final position, since the connections are done from the back of the appliance:

- Electrical connections (if needed for fan kit)

Installation Planning

Overview

Note

This appliance may **ONLY** be installed in an existing unaltered, functioning solid-fuel burning fireplace with a working flue and constructed of non-combustible material.

DO NOT install into combustible construction. This appliance is **NOT APPROVED** for installation with a zero clearance kit.

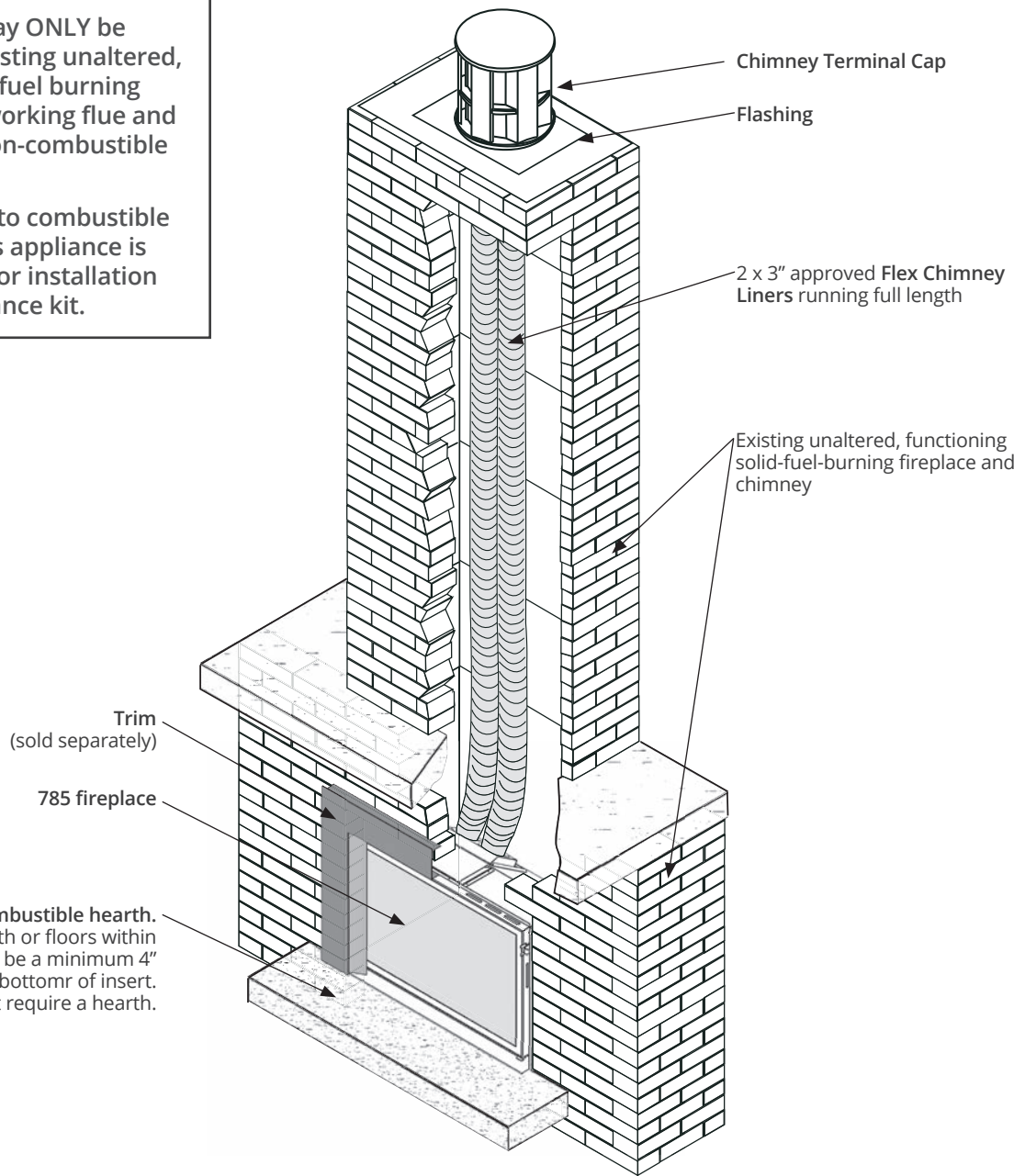

WARNING

HOT HEARTH / FLOOR! The hearth or floor in front of the fireplace may become very hot when the fireplace heats. Do not use the hearth as a seat or shelf. Solid wood flooring in front of the fireplace (if allowed) may shrink during the heating season due to heat.

WARNING

Some materials or items, although safe, may discolor, shrink, warp, crack, peel, and so on because of the heat produced by the fireplace. Avoid placing candles, paintings, photos, and other items sensitive to heat around the fireplace.

Venting

Overview

Typical Vent Installation

NOTE: Flexible co-linear vent pipes may only be installed into existing non-combustible solid-fuel burning fireplaces and chimneys.

The appliance must not be connected to a chimney flue serving a separate solid-fuel burning appliance. See *Approved Venting Components* on page 30 of this manual.

Vent Location

The vent terminal must be located through the roof. This direct vent appliance is designed to operate when an undisturbed airflow hits the outside vent terminal from any direction.

Check local codes for allowable vertical vent termination.

Venting Table

Maximum vertical height	40 ft (measured to bottom of termination)
Minimum vertical height	10 ft (measured to bottom of termination)
Maximum horizontal run	4 ft (measured center to center of pipe)
Maximum offset angle	45° (sweeping bend to allow for obstructions)

Venting Notes

Where possible, avoid joining flex pipes. If joints are required, use an approved connector and seal joints with RTV high temp sealant.

Horizontal offset is permissible to allow for routing around masonry projections. Avoid bending flex pipe over a 45 degrees radius where possible.

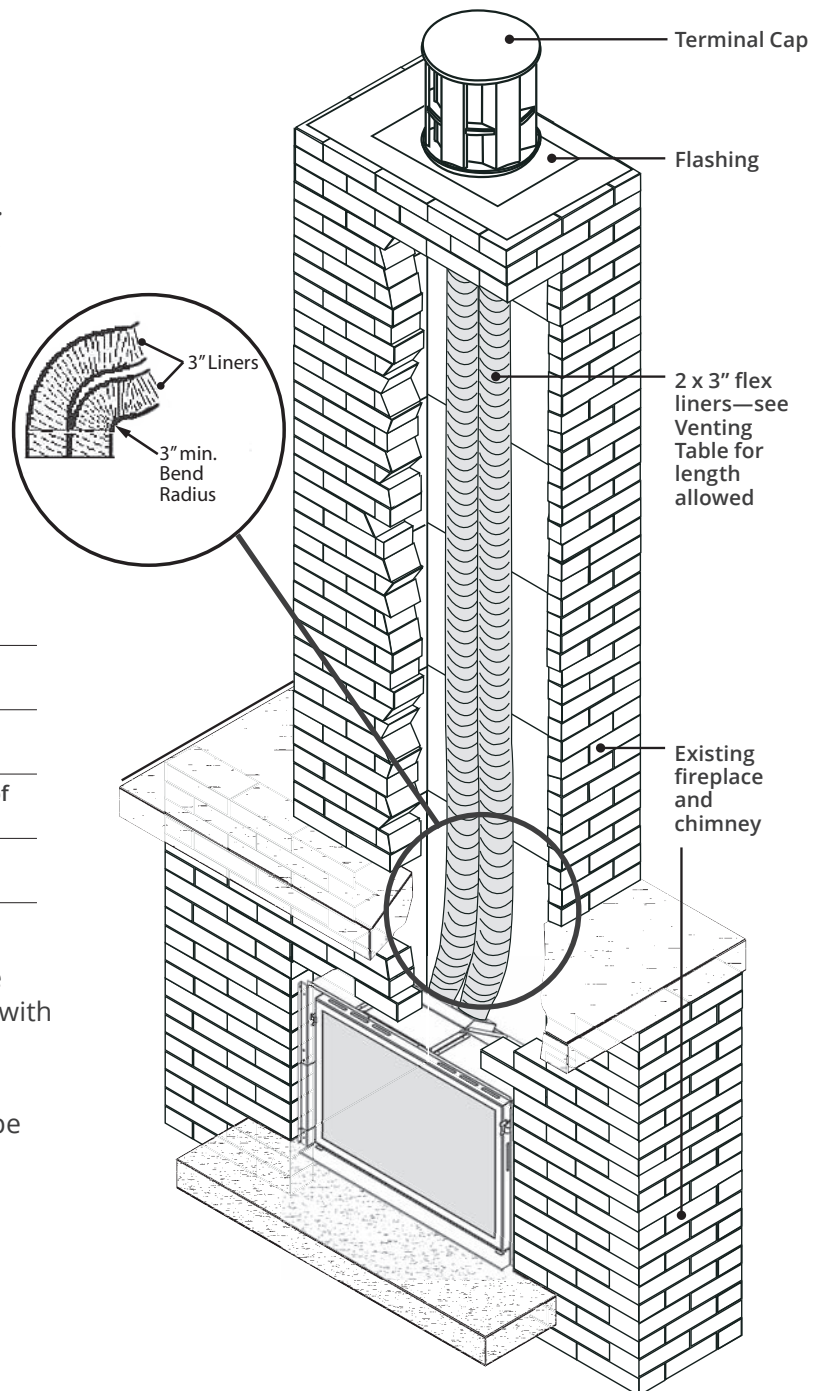

Installation Preparation

Existing Fireplace Preparation

A few points must be considered before inserting the 785 into an existing fireplace cavity. Generally, no modifications are allowed to the existing fireplace that will compromise the integrity of the existing fireplace.

Components that are bolted or screwed on such as dampers or baffles may be removed to accommodate the installation of the 785 engine. Refractory bricks and log grates may also be removed.

Cutting away any sheet metal parts of the existing fireplace to accommodate the installation of the 785 is prohibited.

Check with local authorities if in doubt.

Clean Fireplace and Chimney

Have the chimney swept and the fireplace cavity including ash dumps and clean-outs cleaned before installing the 785 heater and vent liners. Any creosote or soot residue remaining in the fireplace cavity chimney or clean-out may cause odors or stains once the 785 insert is installed. Consult with chimney sweep for information on how best to clean.

Existing Dampers

Factory-built, zero-clearance fireplaces will require the damper to be removed in order to install the vent liners. These dampers are usually bolted into place. Dampers in masonry fireplaces must be fixed open and may remain in place.

Ash Retaining Curbs

Some fireplaces (particularly factory-built) have a raised curb at the front edge to retain ashes. Check the dimensions carefully to ensure the 785 engine will fit behind any raised curb (some curbs may be removed separately from the refractory base).

Gas Line Routing

Plan the routing of the gas line before proceeding. Utilize the existing hole for the gas line of the factory-built fireplace.

If the fireplace has no access hole, carefully drill an access hole of 1.5 inch (38 mm) or less through the lower sides or bottom of the firebox. The access hole must be plugged with non-combustible insulation after the gas supply line has been installed.

See *Dimensions* section for detailed location of gas inlet. Also, take into consideration whether or not a fan or shut-off valve will interfere when planning routing of

the gas line.

Existing Glass Doors and Wire Screens

Existing glass doors must be permanently removed prior to installing the 785 insert.

Combustible Mantels

Combustible mantel clearances must conform to those required for the original solid-fuel fireplace into which the 785 is being installed.

Attach Warning Conversion Plate to Existing Fireplace

(Label supplied loose with 785 heater)

Attach the "This fireplace has been converted..." label to the existing fireplace using screws or other mechanical means and store any removed parts in back of the existing fireplace for future use.

Unpack the Appliance



WARNING

Beware of sharp edges! Wear gloves!

1. Unpack the appliance.
2. Unpack any loose items from around the appliance and check against the Pack Content list provided in the documentation package.
3. Remove the window and set aside in a safe place to avoid damage—see next page.
4. Verify that you have all the components required for the installation, including:
 - liner panels
 - fuel bed
 - trim
 - venting components and accessories
 - fan and electrical components for its installation (if used)

Installation Preparation

Window and Fan

Remove Window

The window is held in place by a spring-loaded lever on each side. To remove the window:

1. Locate the levers on each side of the window towards the top. Using your finger, pull the lever towards you and unhook it from the window frame bracket.

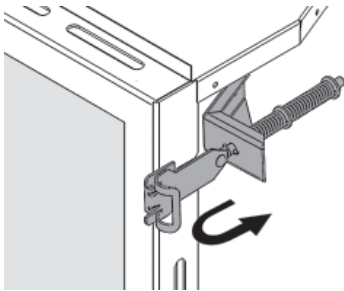

2. Gently pull the top of the window outward.

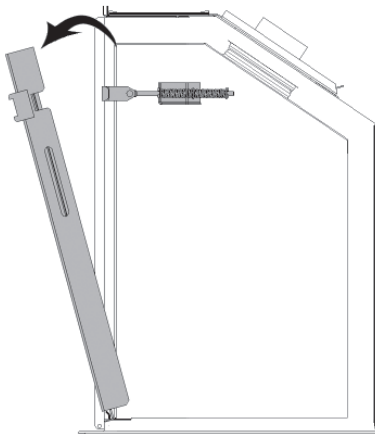

3. Lift the window out of its bottom railing and set it aside in a safe place to avoid damage.

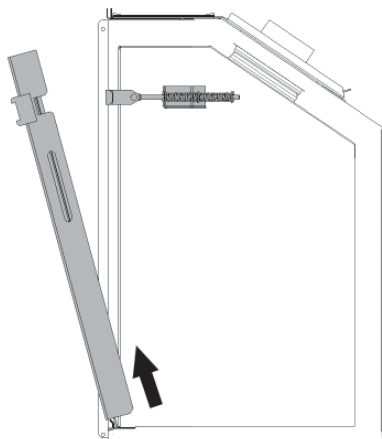

Install Fan Kit (if used)

If the 795CFKV2 Circulating Fan Kit (blower) is to be installed, we suggest that you do it now.

The fan cavity is accessible from the back of the firebox to facilitate its installation. If the fan is retrofitted after the installation of the appliance, the appliance will need to be removed. Therefore, we recommend that, where possible, the fan be installed before the appliance is fitted into the cavity.

Refer to instructions provided with the 795CFKV2 to install the fan.

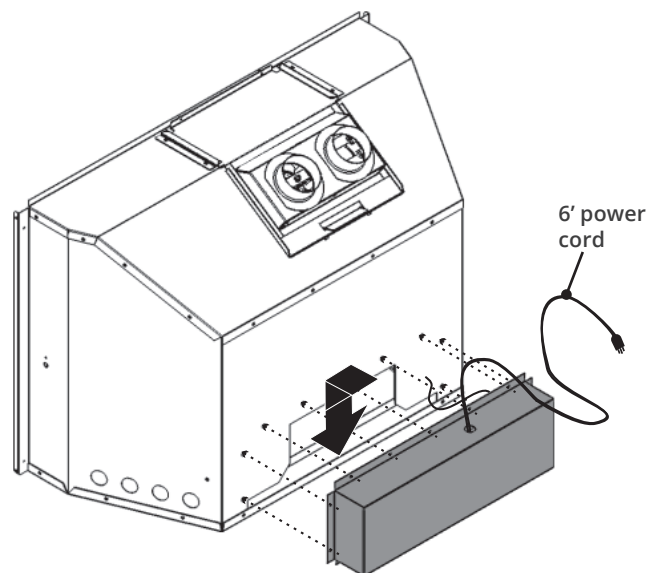

Installation

Connect Venting

Connect Venting

IMPORTANT: This appliance's venting system is room sealed and therefore, does not require room air to be used in the combustion process.

1. Rough-in two 3" diameter vent liners into the existing chimney system from the roof. Be careful not to tear or damage the liners in the process. It may be easier to install both liners at the same time rather than one at a time. Leave plenty of liners at the bottom to facilitate the connection of the liners to the vent slider. **It is best to leave the top termination until later. Designate and mark the top and bottom of one liner as "EXHAUST" to avoid confusion later.**
2. Release the two screws retaining the vent slider to the front of the firebox. Remove the slider from the firebox by sliding it towards the back of the firebox.
3. Fit the two liners ensuring that the exhaust liner is connected to the identified "EXHAUST" vent collar. Secure liners to collars with hose clamps (included) and 2 tapping screws per liner.
4. Slide the firebox onto the vent slider in the cavity taking care not to damage the liners. **Make sure that the rear edge of the slider is hooked over the cleat on the firebox.** Secure the vent slider to the front of the firebox with two screws removed earlier.
5. From the roof, pull the liners and fit the flashing.
6. Fit the terminal cap ensuring that the exhaust liner is connected to the exhaust vent collar. Secure with screws.
7. Seal the terminal and flashing from water penetration as required.

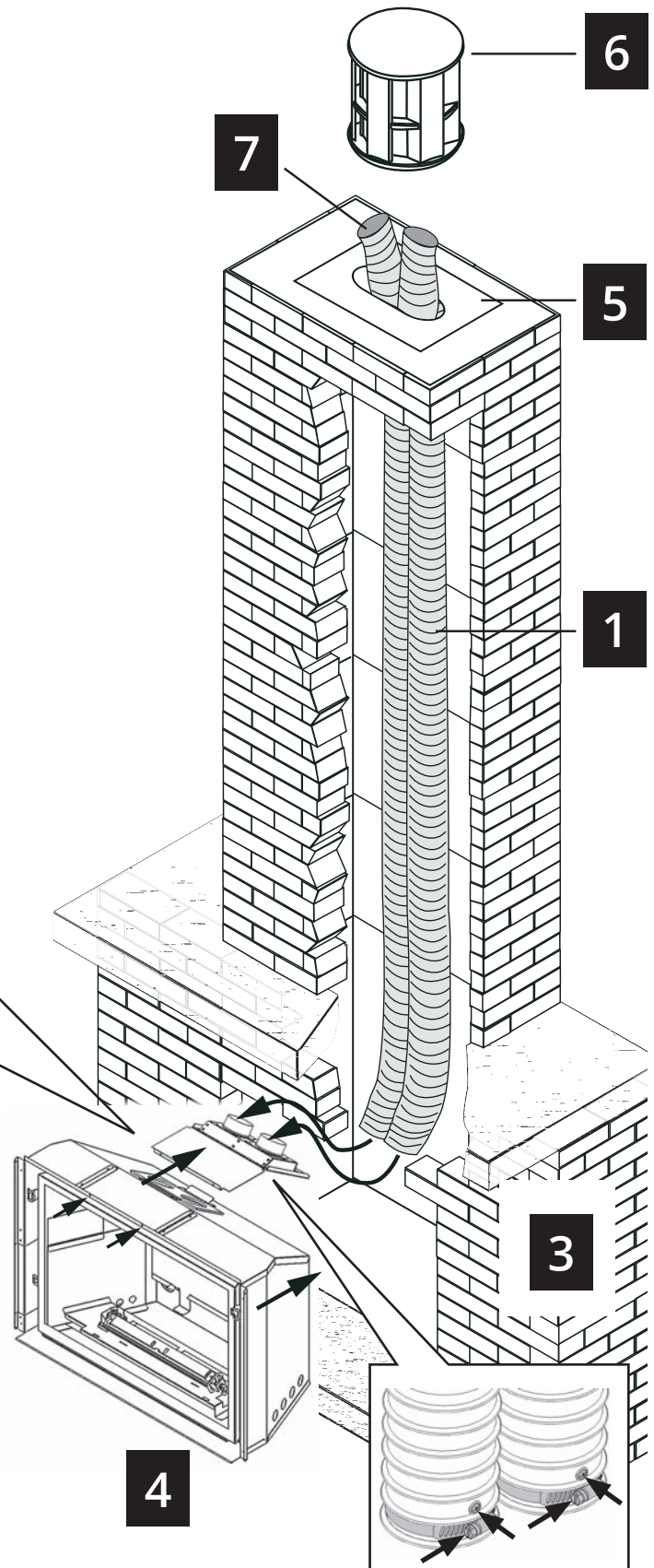
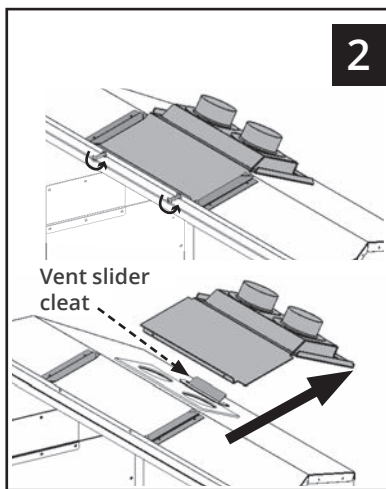

WARNING

Failure to position the parts in accordance with these diagrams or failure to use only parts specifically approved with this appliance may result in property damage or personal injury.

Installation

Gas Supply

Connect Gas Supply

The gas supply inlet connection is a 1/2" NPT female. Stainless steel flexible connector with gas shut-off valve supplied with the appliance.

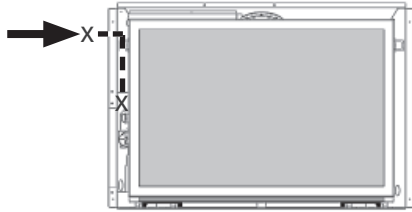

Use only new black iron or steel pipes, CSST, or copper tubing if acceptable—check local codes. Note that in USA, copper tubing must be internally tinned for protection against sulfur compounds.

The burner module and gas train on this appliance may be removed as a unit for servicing. The flex pipe supplied with the unit provides a union for removal of the module.

Unions in gas lines should be of ground joint type.

The gas supply line must be sized and installed to provide a supply of gas sufficient to meet the maximum demand of the appliance without undue loss of pressure.

Sealant used must be resistant to the action of all gas constituents including LP gas. Sealant should be applied lightly to male threads to ensure excess sealant does not enter gas lines.

Pressure test the supply line for leaks.

The appliance and its individual shut-off valve must be disconnected from the gas supply piping system during any pressure testing of that system at test pressures in excess of 1/2 psig (3.5 kPa).

The appliance must be isolated from the gas supply piping system by closing its equipment shut-off valve during any pressure testing of the gas supply piping system at test pressures equal to or less than 1/2 psi (3.5 kPa).

Failure to either disconnect or isolate the appliance during pressure testing may result in regulator or valve damages and void the warranty. Consult your dealer in case of damages.

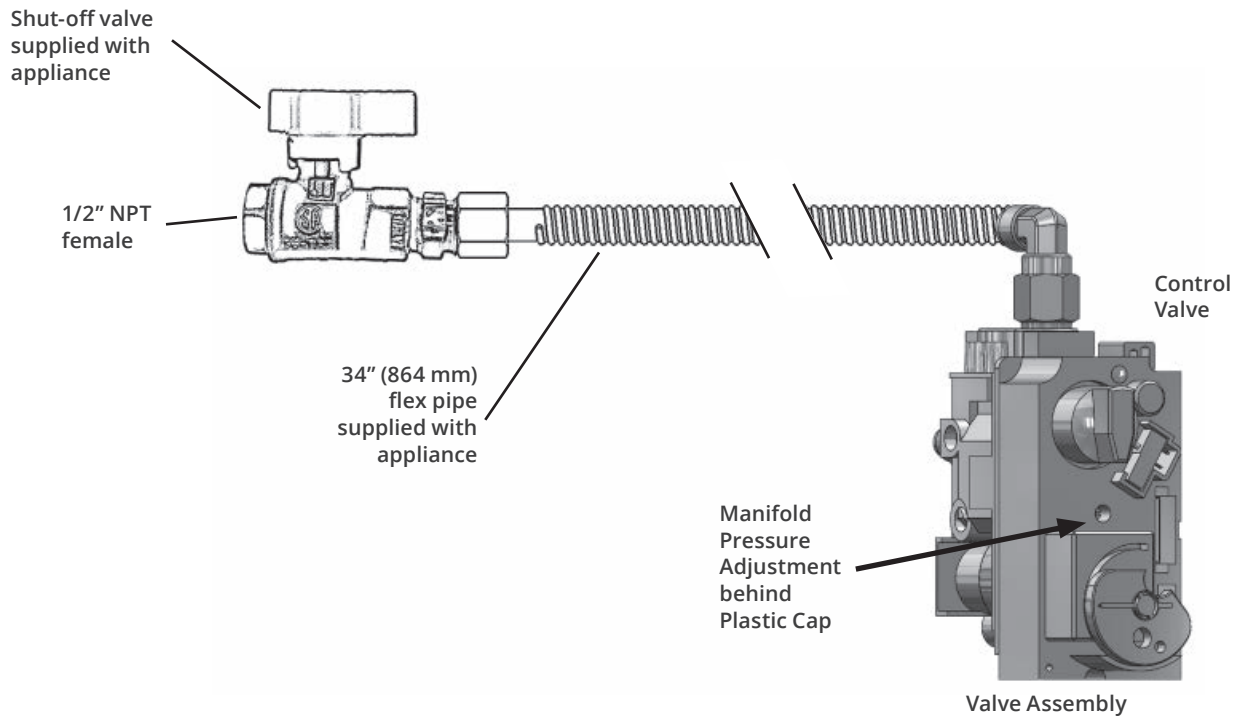

Pressure Test Points

The minimum supply pressure is given in the section *Specifications* on page 6 of this manual.

All piping and connections must be tested for leaks after installation or servicing. All leaks must be corrected immediately.

When testing for leaks:

- Make sure that the appliance is turned off.
- Open the manual shut-off valve.
- Test for leaks by applying a liquid detergent or soap solution to all joints. Bubbles forming indicate a gas leak.



WARNING

NEVER USE AN OPEN FLAME to check for leaks. Correct any leak detected immediately.

The pressure test tapping locations are shown in the figure below. An internal regulator within the valve controls the burner manifold pressure.

The correct pressure range is shown in the table in section *Specifications* of this manual on *Specifications* on page 6.

The pressure check should be made with the burner alight and at its highest setting—see *Appendix A-Lighting Instructions Plate* on page 31 for full operating details.

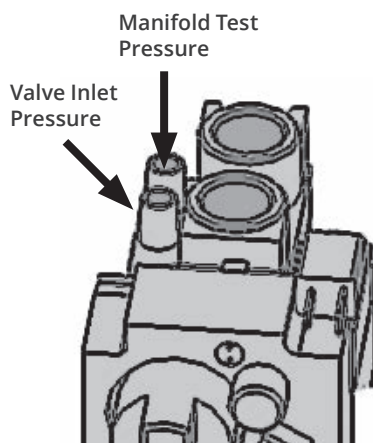

Installation

Gas Supply

Alternate Inlet Connection

In cases where local codes do not permit the flex connector to be used inside the appliance case, reconnect the flex connector outside of the appliance case. A cut-out is provided in the appliance case for this purpose.

Use common elbow and fittings (not supplied) to redirect the position of the flex connector. NOTE: the flex connector bend radius must be no smaller than the size of a golf ball (approx. 1-3/4" or 44 mm).

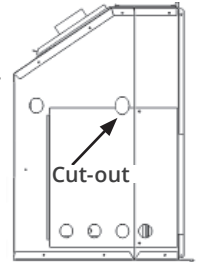

1. Remove flex pipe from elbow.

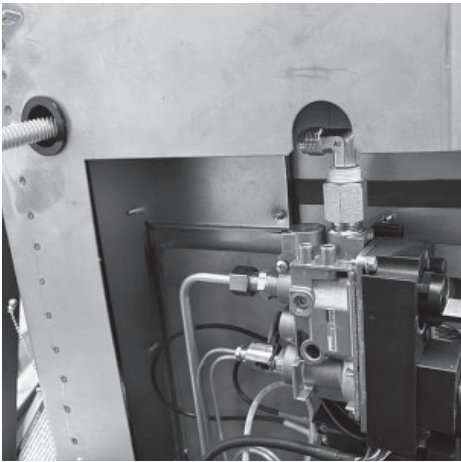

2. Remove elbow.



3. Install new inlet elbow.

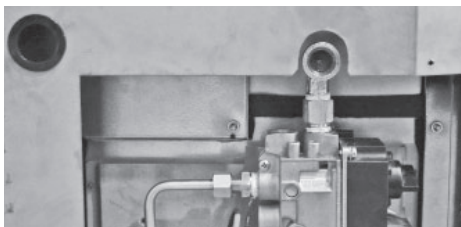

Common fittings required (not supplied)

- Option 1
4. Add flared connector to new elbow and fit flex connector. Close the access panel.

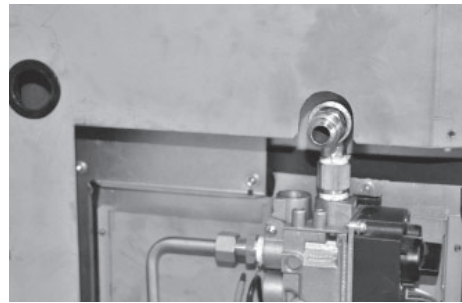

Flex connector redirected using one elbow.



Top view, left side



Front view, left side

Option 2

4. Add another elbow, the flared connector and refit the flex connector. Direct it towards the rear of the appliance or downward. Close the access panel.

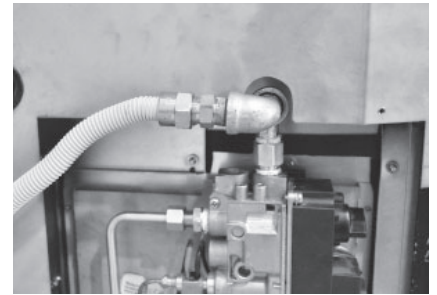

Flex connector redirected using two elbows.

Installation

Liner Panels

Remove and Re-install Burner (if necessary)

The ceramic panels can be installed without removing the burner. However, you can remove the burner for additional space if desired.

1. Remove the screw fixing the rear of the burner to the manifold bracket as indicated.
2. Grab the burner and gently pull up the rear first while pushing back and unhooking the front tabs from their retaining lances. **Be careful not to hook the pilot hood as you pull the burner up.**

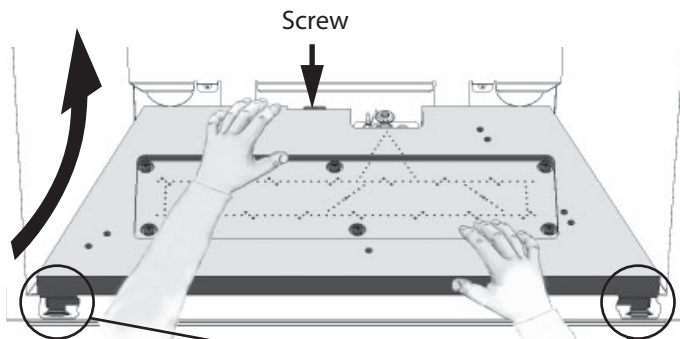

3. To re-install the burner, fit the burner in the firebox inserting the front tabs first in the lances.

Note: Ensure the front of the burner is well hooked when re-installing! Again be careful not to hook the pilot hood when fitting the burner over the pilot.

4. Secure the burner to the manifold bracket at the rear with screw.

Install Liner Panels

The following guidelines apply for all liner panels (with the exception of the 787RGL Reflective Glass Liners—see the installation manual supplied with that liner kit for details). You do not need to remove the burner to install the panels unless installing the 785RGP Reflective Glass Panel—see instructions provided with the Glass Panel.

1. Inside the firebox, on the top of each side, loosen the screw of the side panel anchors (one per side) just enough to allow them to rotate (one per side).

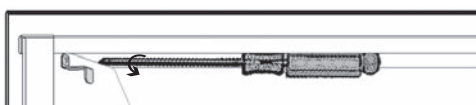

2. Place the rear panel against the back of the firebox, on the ledge at the bottom, behind the burner.

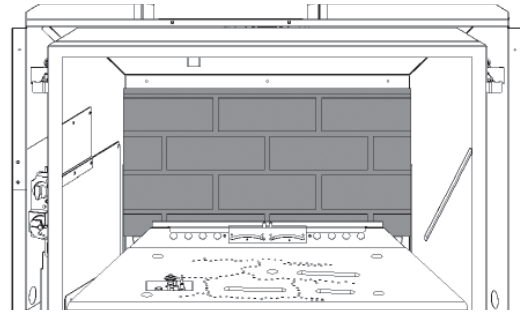

3. Rotate the anchor up and out of the way and slide the left hand side panel against the firebox side. Rotate the anchor back down to hold the panel.
 4. Rotate the anchor up and out of the way and slide the right hand side panel against the firebox side. Rotate the anchor back down to hold the panel.
- IMPORTANT: Ensure both side panels sit flat against the sides of the firebox particularly at the rear corners to prevent unstable pilot at start-up.**

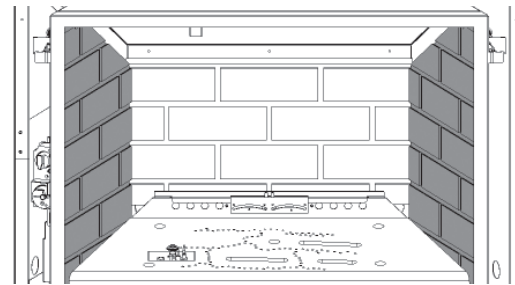

5. Tighten the side panel anchors on each side of the firebox.

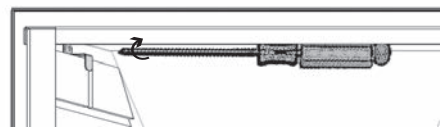

6. Install the top panel supporting it with the back and side panels.

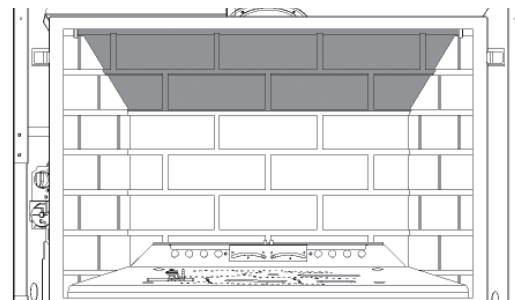

7. Discard the front bricks as they are not required on this fireplace.

Installation

Fuel Beds

Driftwood 1101DWK

Material required

- Long Beach Driftwood Kit, which contains:
 - 3 logs
 - 5 pebbles
 - 1 x 1.5lb bag of 3/4" grey/black shale
- Gloves, if desired

Installation

Carefully unpack the kit.

Logs

Each log has pegs to help you place them on the burner platform. Install the logs as shown below.

1. Place the left log on the left side of the ceramic burner inserting its two pegs in the holes of the burner.

Note: There are two sets of holes for this log depending which type of gas is used for the appliance.

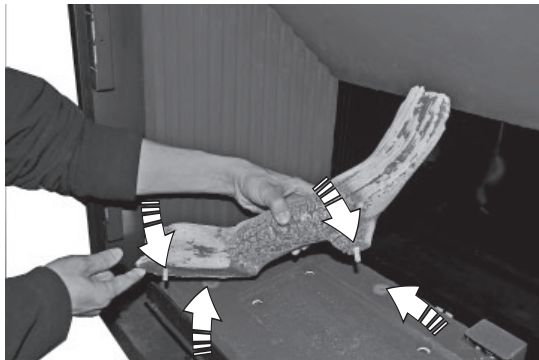

Natural gas fire: Place the log forward in the firebox.

Propane gas fire: Place the log rearward in the firebox.

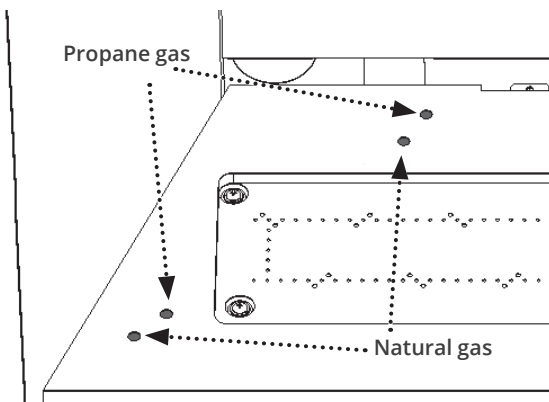

2. Place the right log on the right side of the ceramic burner inserting its two pegs in the holes of the burner. The rear end of the log rests on the pilot shield.

Note: There are two sets of holes for this log depending which type of gas is used for the appliance.

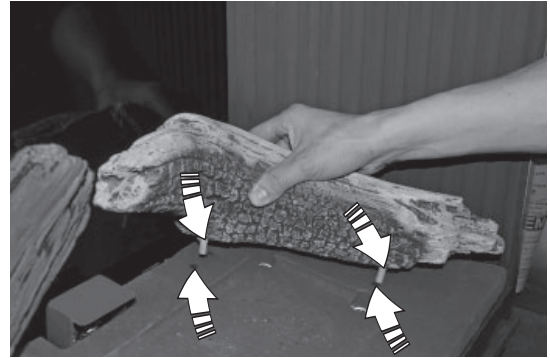

Natural gas fire: Place the log forward in the firebox.

Propane gas fire: Place the log rearward in the firebox.

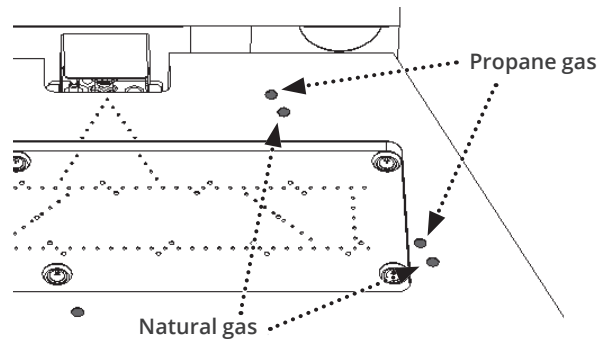

Installation

Fuel Beds

3. Place the center log inserting its peg into the hole on the front of the burner and resting the other end of the log in the slight depression on top of the left log.



4. Carefully spread shale in the cavity of the ceramic burner. You can also add some shale on cavity outer edge.

Note: Ensure the area within the pilot shield is clear of shale pieces.

Pebbles

Place the pebbles on the platform as shown below.



IMPORTANT: Approved for use only with the ceramic shales provided for your Valor fireplace. The use of any other products may void your fireplace warranty.

WARNING

Choking Hazard! Ensure that the fireplace area is clear of shales as these could be ingested by small children. Vacuum area after installation.

Installation

Fuel Beds

Decorative Glass Murano 785XDGM

Material required

- Decorative Glass Murano Kit, which contains:
 - 1 glass platform
 - 1 glass piece for pilot cover
 - 2 platform retainers
 - 1 pilot cover
 - 1 bag of clear 1/2" fireglass
- Gloves (recommended to manipulate glass)

Installation

Carefully unpack the kit. Wear gloves to handle the fireglass.

1. Install the platform retainers as indicated.

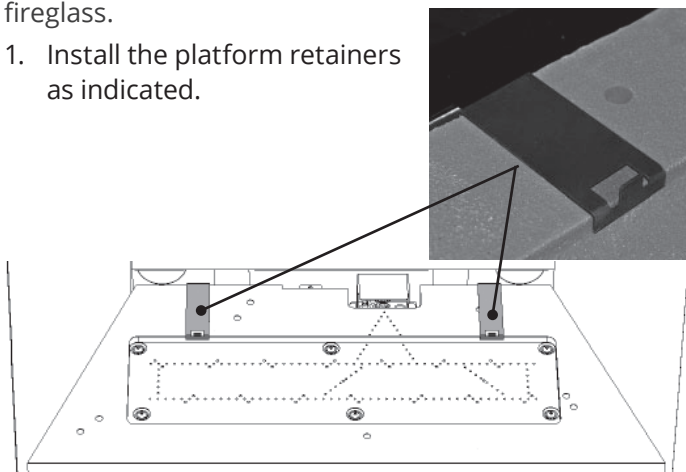

2. Place the pilot cover on the ceramic burner over the pilot shield. The lip on the top surface goes to the front.

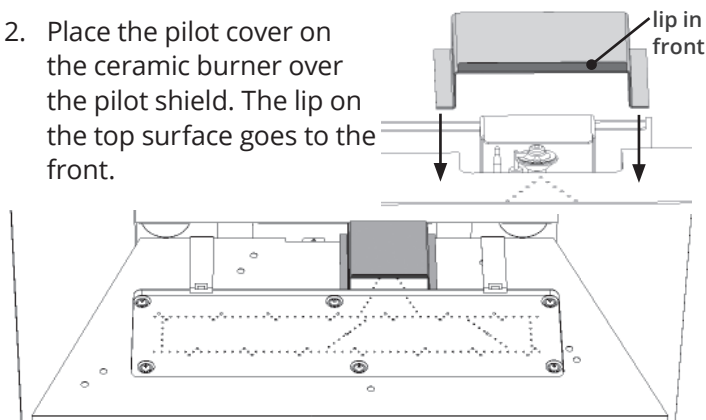

3. Install the glass platform on top of the retainers.

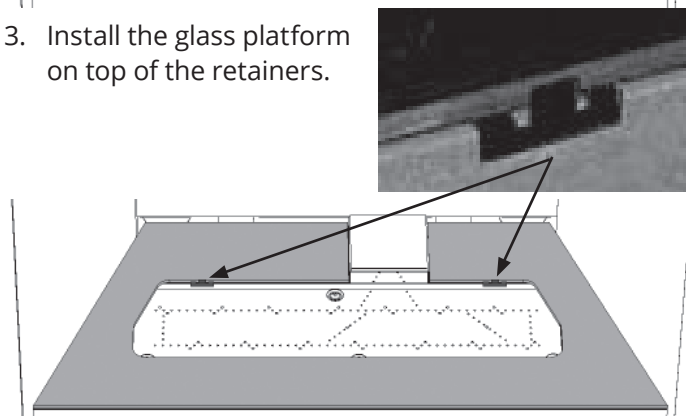

4. Carefully spread the glass by hand, on top of the burner within the platform opening.



5. Install the square glass panel on top of the pilot shield.

NOTE: Ensure the area within the pilot shield is clear of glass particles.

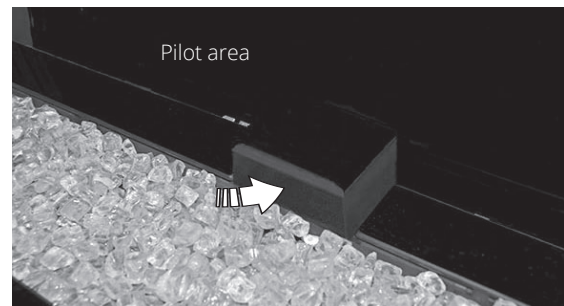

IMPORTANT: Approved for use only with the fireglass provided for your Valor fireplace or fireglass brands *American Fireglass™* or *Firegear*. Use of other fireglass or crushed glass can cause damage to your fireplace and void the warranty.

WARNING

Choking Hazard! Ensure that the fireplace area is clear of fireglass pieces as these could be ingested by small children. Vacuum area after installation.

Installation

Install Window

Refit and Check Window

1. Place the window in its bottom railing and push its top against the firebox. Ensure to remove any particles in the railing before installing the window.

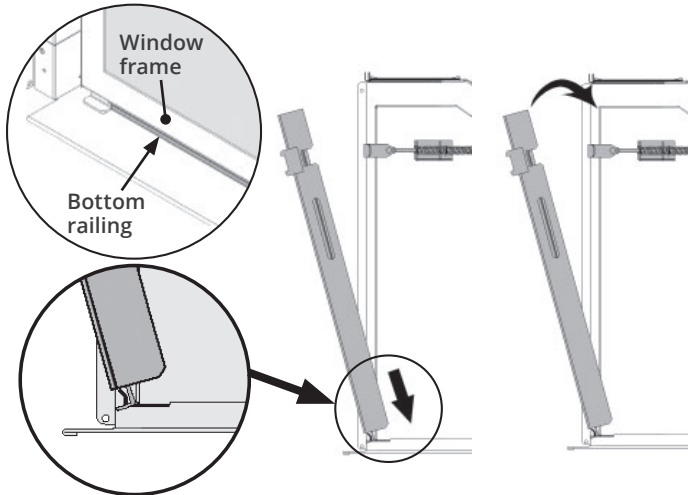

2. While you hold it, hook the side levers into the window tabs.

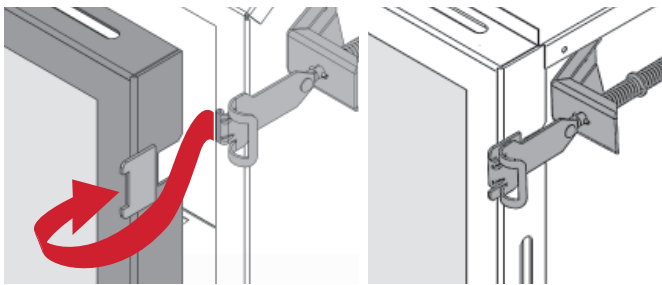

3. Pull out the top of the window and release it to ensure the springs return it.
4. Apply firm hand pressure around the window frame to ensure the window is sealed tight against the firebox.
5. If the Hot Glass Warning plate has been removed from the front lower corner of the window, reinstall it by sliding it between the glass and the frame as indicated below.

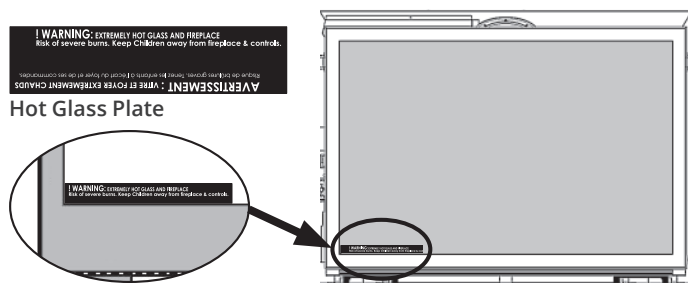

WARNING

The window unit must be correctly installed, fastened and sealed after servicing or serious bodily injury and/or damage to the appliance may result.

To ensure a safe operation:

- Double-check that the bottom of the window frame is correctly installed in the bottom support railing;
- Verify that the levers are hooked properly to the window tabs then;
- Pull out the top of the window and release it to insure the springs return it;
- Ensure the window is sealed before operation.

WARNING

Failure to install the window correctly can:

- Leak carbon monoxide.
- Affect the performance of the fireplace.
- Damage components.
- Cause overheating resulting in dangerous conditions.

Damage caused by incorrect window installation is not covered by the Valor Warranty.

Installation

Synchronize Remote Control

The receiver and the handset of the remote control system must be initially synchronized before the first use.

1. Remove the battery holder cover (1 screw).
Insert 4 x 1.5V alkaline batteries in the holder.



2. On the left hand side of the firebox, pull the loose wire that is already connected to the receiver and connect it to the battery holder. .

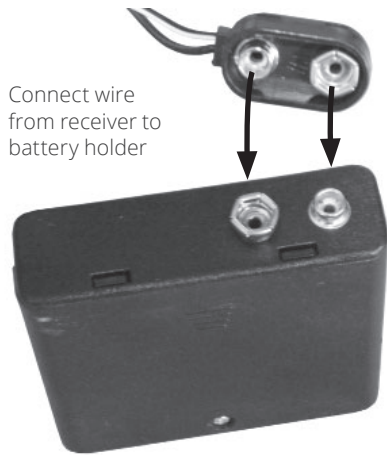

3. Insert 1 9V alkaline battery in the handset.

Remote Control Pairing

4. With a sharp object, press and hold the receiver's RESET button until you hear one short and one long beep. Release the reset button after the second beep.

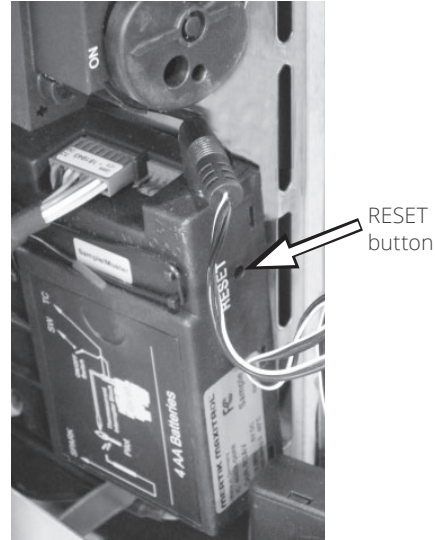

5. Within the subsequent 20 seconds, press the small flame button on the remote handset until you hear two short beeps confirming the synchronization is set.

This is a one time setting only and is not required when changing the batteries in the remote handset. The remote control system is now ready to use.

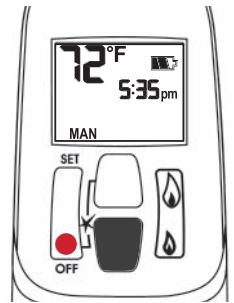

6. Inside the left panel of the appliance outer case, in front of the receiver, peel off the Velcro backing and stick the battery box on it to keep it in place.

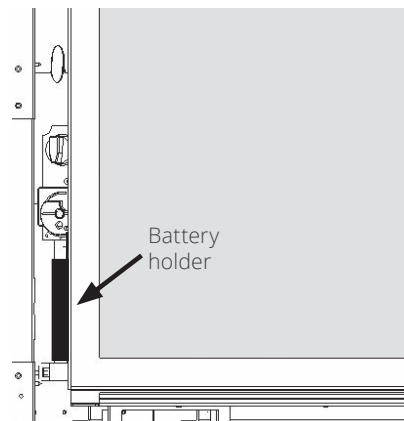

Installation

Check Operation

Turn the fireplace flame up and down using the remote control to confirm that the full range of inputs is achieved—see *Appendix B—Remote Control Operation* pages 32–35.

Adjust Aeration (if necessary)

Light the fire and allow the unit to warm up for 10–15 minutes to evaluate the flame picture. Burners are equipped with an adjustable shutter to control primary aeration. See the figures below. The shutters are factory-set to an aeration gap which will give optimum performance for the vast majority of installations.

Depending of fuel bed used, altitude and other considerations, the flame picture may be improved by adjusting the aeration. The need for adjustment should be determined only by operating the appliance with the fuel bed, liners and window installed and evaluating the flame picture after a 15-minute warm-up.

Increasing aeration (open) will cause the flames to appear more transparent and blue showing more ceramic effects glow.

Decreasing aeration (close) will cause the flames to appear more yellow or orange showing less ceramic effects glow.

Too little aeration may result in black carbon forming on the logs or roof panel and dropping into the firebox. May also result in carbon or soot stains on the vent termination and exterior wall around the termination! The Manufacturer is not responsible for any damage caused by an air shutter setting with too little aeration.

Air Shutter

To access the air shutter, very carefully remove the ceramic burner. The air shutter is located under the burner at the back as shown.

1. Remove the screw fixing the rear of the burner to the manifold bracket as indicated.

Check Operation and Aeration

2. Grab the burner and gently pull up the rear first while pushing back and unhooking the front tabs from their retaining lances. **Be careful not to hook the pilot hood as you pull the burner up.**

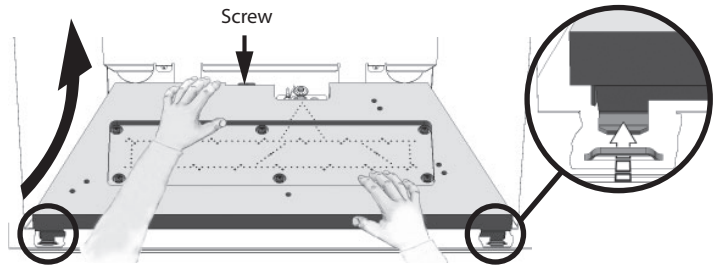

3. Loosen the air shutter nuts, adjust and re-tighten.

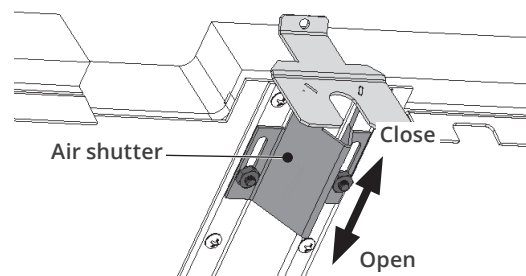

4. To reinstall the burner, fit the burner in the firebox inserting the front tabs first in the lances. **Note: Ensure that the front of the burner is well hooked when re-installing!** Again, be careful not to hook the pilot hood when fitting the burner over the pilot.

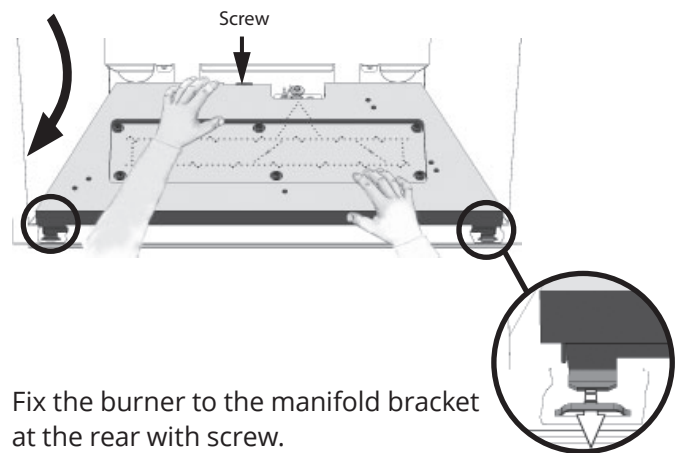

5. Fix the burner to the manifold bracket at the rear with screw.

Installation

Front/Trim

Install Side Shrouds

The side shrouds are required to install the front on the appliance. They are supplied with the engine.

Fit them to the appliance outer case as indicated (2 screws/side).

See instructions supplied with the front trim for installation of trim.

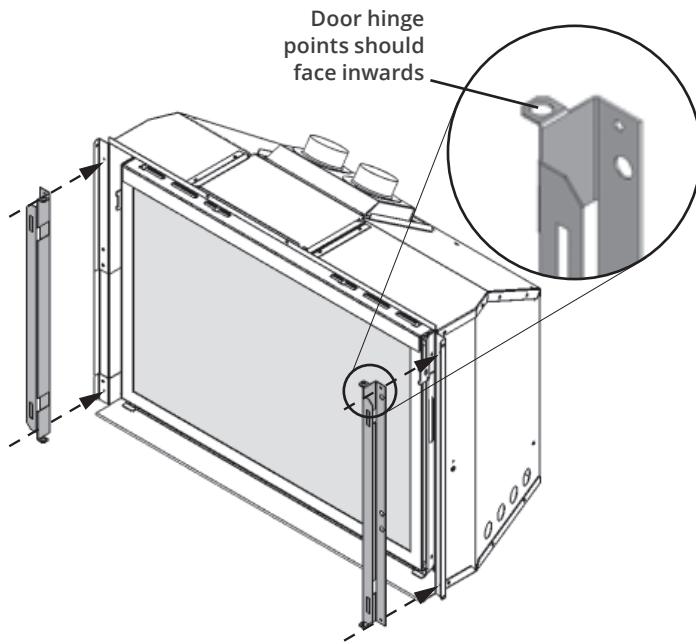

Install Front, Trim and Barrier Screen

Install the front or trim chosen by the customer for their fireplace. Install as well the barrier screen which is provided with the front or trim.

Show the customer how to access the controls when the front or trim are installed and how to remove them.

Follow the instructions provided with the front or trim and leave those instructions behind for the customer's further reference.

Installation

Handset Wall Holder

Install Handset Wall Holder

The remote control kit for this fireplace comes complete with a wall-mounted holder. This holder is not required in all installations but is provided as an optional feature for those customers who wish to mount the remote handset to the wall.

To install the holder to the wall, find a convenient location and use the hardware provided with the kit. See the diagram below for required hardware and configurations. Note that the holder can be installed at the base of a light switch plate.

IMPORTANT. The location of the remote control handset is important to assure proper temperature regulation. To obtain a constant temperature, we recommend that the handset should be between 3 and 15 feet away from the appliance **but not directly above it**. We also advise that the handset should be located away from any other heat source and not in direct sunlight as this may affect the temperature sensor located in the remote handset.

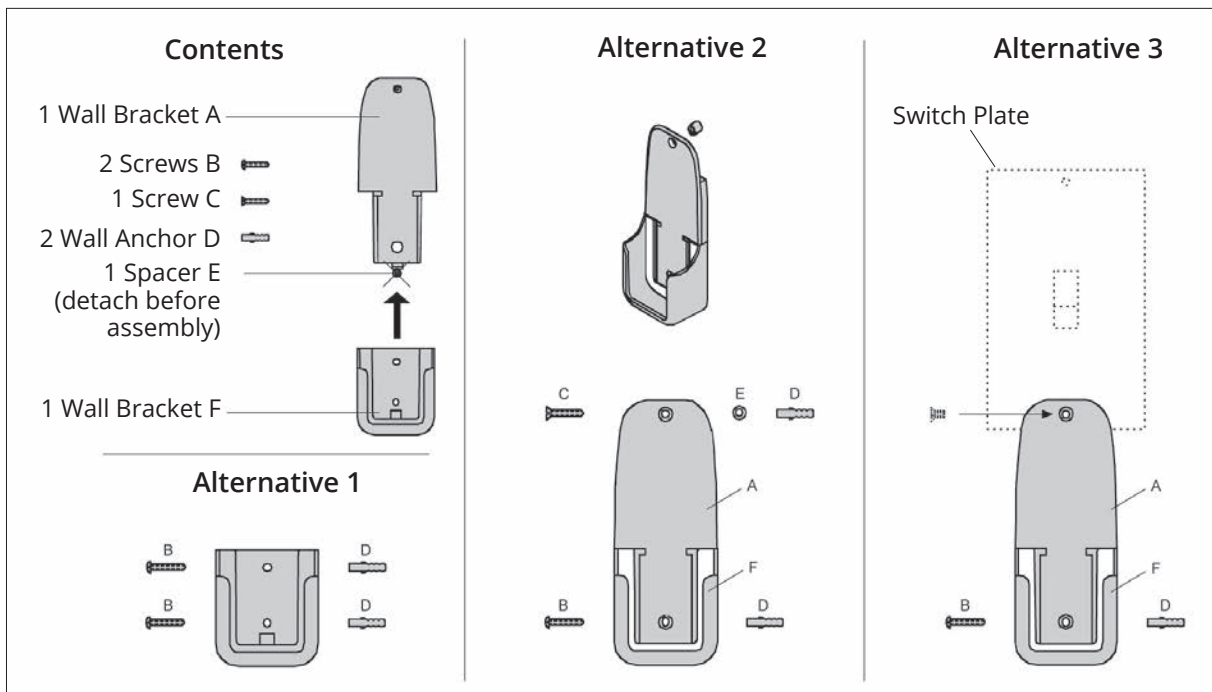

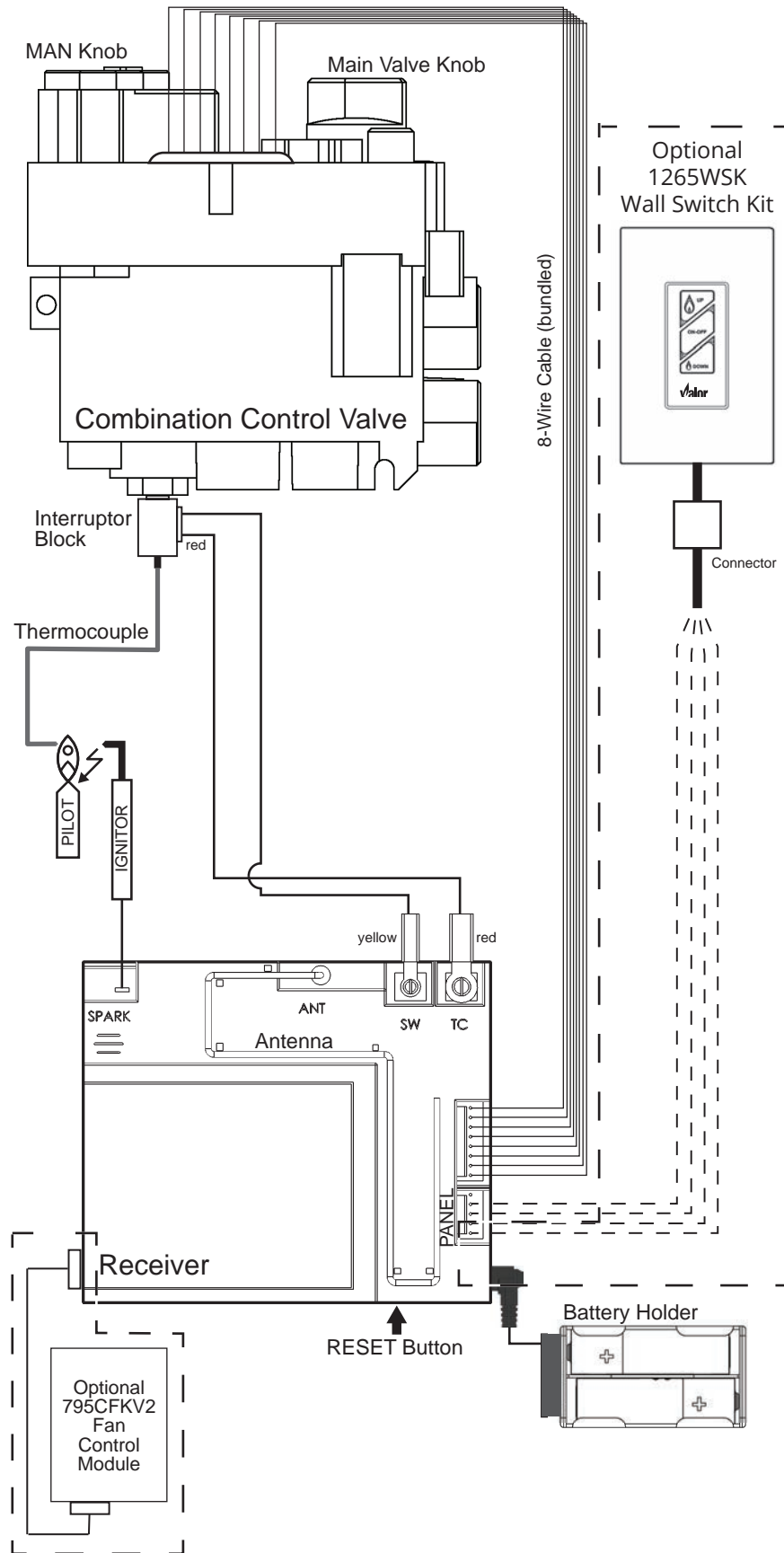

Wiring Diagram

GV60 Wiring Diagram



Approved Venting Components

Approved Direct Vent Suppliers for Valor Models 700 ³ , 739 ² , 780 ³ and 785 ⁴							
  Venting Parts Description		Venting Parts Code / availability by Manufacturer					
		DURA-VENT	SELKIRK	ICC EXCEL DIRECT	AMERIVENT	MILES INDUSTRIES	BDM
Termination Caps	Vertical	Standard Co-axial	46DVA-VC	4DT-VT	—	4DVC 4DH-1313	— DVR6-VCH DVR6-VCSB
		High Wind Co-axial	46DVA-VCH	—	TM-4SVT	—	—
		Extended Co-axial	46DVA-VCE	—	—	—	—
	Vertical	Co-linear	46DVA-CL33 46DVA-CL33H 46DVA-CL33P	—	TM-IVT	HCL-99-33 HCL-913-33 HCL-1313-33	559CLT 940033B 940033HWS 940033RD
Horizontal			—	—	—	—	—
Vent Adapters / Couplers	Universal Adapter 3” Flex Coupler		2150	—	TM-CFAA3	—	95090390
	Co-linear Flex Connector		46DVA-ADF	—	—	—	—
	Co-linear-to-Co-axial Adapter		46DVA-GK 46DVA-CLTA	—	TM-4CTA	4DCAT33	—
Aluminum Flexible Liner	3” diameter		NOTE: 2-ply liner approved to CAN/ULC S635 suitable for venting gas appliances. As manufactured by Z-Flex, Flexmaster and others.				
			2280 Series	AF3-35L	TM-ALK33 TM-ALT33	—	—
Flashings	Roof Flashing 0/12-6/12		46DVA-F6	4DT-AF6	TF-4FA	4DF (0/12-5/12)	— DVR6-AF012
	Roof Flashing 7/12-12/12		46DVA-F12	4DT-AF12	TF-4FB	4DF12 (6/12-12/12)	— DVR6-AF712
	Flat Roof Flashing		46DVA-FF	—	TF-4F	—	— DVR6-TCF
	Masonry Flashing		—	—	TF-4MF	—	559FSK

- Notes:**
1. Follow instructions supplied with each manufacturer's components.
 2. The 720SWK-M Sidewall Kit can only be installed on the 739M and 739V models.
 3. The 720SWK-M2 Sidewall Kit can only be installed on the 700M and 780M models.
 4. The 720SWK-M2 Sidewall Kit CANNOT be installed on the **785Y** models.

Appendix A–Lighting Instructions Plate

FOR YOUR SAFETY, READ BEFORE LIGHTING

WARNING: If you do not follow these instructions exactly a fire or explosion may result causing property damage, personal injury or loss of life.

A. This appliance has a pilot which must be lighted by hand or by remote control. Follow these instructions exactly. To save gas, turn the pilot off when not using the appliance for a prolonged period of time.

B. **BEFORE LIGHTING**, smell all around the appliance area for gas. Be sure to smell next to the floor because some gases are heavier than air and will settle on the floor.

WHAT TO DO IF YOU SMELL GAS

- Do not try to light any appliance.
- Do not touch any electric switch; do not use any phone in your building.
- Immediately call your gas supplier from a neighbor's phone. Follow the gas supplier's instructions.
- If you cannot reach your gas supplier, call the fire department.

C. Use only your hand to push in or turn the control knobs. Never use tools. If the knobs will not push in or turn by hand, don't try to repair them; call a qualified service technician. Force or attempted repair may result in a fire or explosion.

D. Do not use this appliance if any part has been under water. Immediately call a qualified service technician to inspect the appliance and to replace any part of the control system and any gas control, which has been under water.

LIGHTING INSTRUCTIONS

1. STOP! Read the safety information above

2. **TO CLEAR ANY GAS**, turn main valve off by pressing OFF (red dot) button on remote handset (1).

- Wait five (5) minutes to clear out any gas, then smell for gas, including near the floor. If you smell gas, STOP! Follow "B" in the safety information above on this label. If you don't smell gas, go to the next step.

3. **AUTOMATIC IGNITION:** MAN-knob (2) in ON position. Ensure Flame Adjustment knob (3) is set to lowest setting (U) (Fig. 1). Locate the pilot (Fig. 3) inside firebox.

- On the remote control handset, press the OFF button (red dot) and large flame button (🔥) simultaneously; a short acoustic signal confirms the start has begun.
- Further short acoustic signals indicate the ignition process is in progress.
- When the pilot is lit, the Flame Adjustment knob (3) will automatically rotate to the highest setting.
- Press the small flame button (🔥) on the remote.

4. **MANUAL IGNITION:** MAN-knob (2) in MAN position (Fig. 2).

With the window off, locate the pilot (Fig. 3) inside firebox.

- Set Flame Adjustment knob (3) to the lowest setting (U).
- Push down the metallic core (4) with a pin or similar instrument; this will establish the pilot gas flow.
- Light gas at the pilot (5) with a match.
- Continue holding down metal core (4) for about 10 seconds; after release, pilot should remain lit.
- If the pilot will not stay lit after several tries, turn the gas control knob (2) to OFF (U) and call your local service technician or gas supplier.
- Reinstall the window and set the MAN-knob (2) to ON; turn Flame Adjustment knob (3) up (O) or down (U) manually or use the flame buttons (🔥) (🔥) on the remote control handset to adjust the flame height.

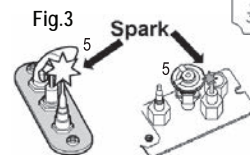
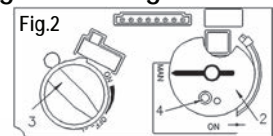
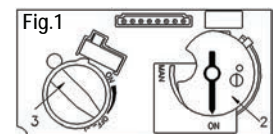
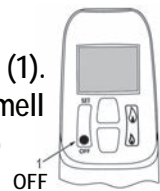

TO TURN OFF GAS TO APPLIANCE

1. **AUTOMATIC SHUT-OFF** (using the remote control handset):

- Press and hold the small flame on the remote control handset to shut-off the main burner gas flow;
- Press "OFF" button (red dot) on remote handset to shut-off the appliance, including pilot flame.

Appendix B-Remote Control Operation

Radio Frequency

315 MHz for USA and Canada.

This device complies with Part 15 of the FCC Rules and with Industry Canada license-exempt RSS standard(s). Operation is subject to the following two conditions:
 (1) this device may not cause harmful interference, and
 (2) this device must accept any interference received, including interference that may cause undesired operation.

NOTE: Before using the remote control system for the first time, the receiver and the handset must be synchronized. See the section *Synchronize Remote Control*.

IMPORTANT: BEFORE YOU BEGIN, please note that on this system, the settings of time, temperature and automatic ON/OFF **can only be programmed when the function display is flashing.** Be patient when programming as it can take a few seconds to set.

Note: In the TEMP or TIMER modes, the remote handset senses the room temperature and adjusts the flame accordingly.

To communicate, the handset should be within 15 feet (4.5 meters) of the fireplace.

Do not leave the handset on the mantel or hearth.

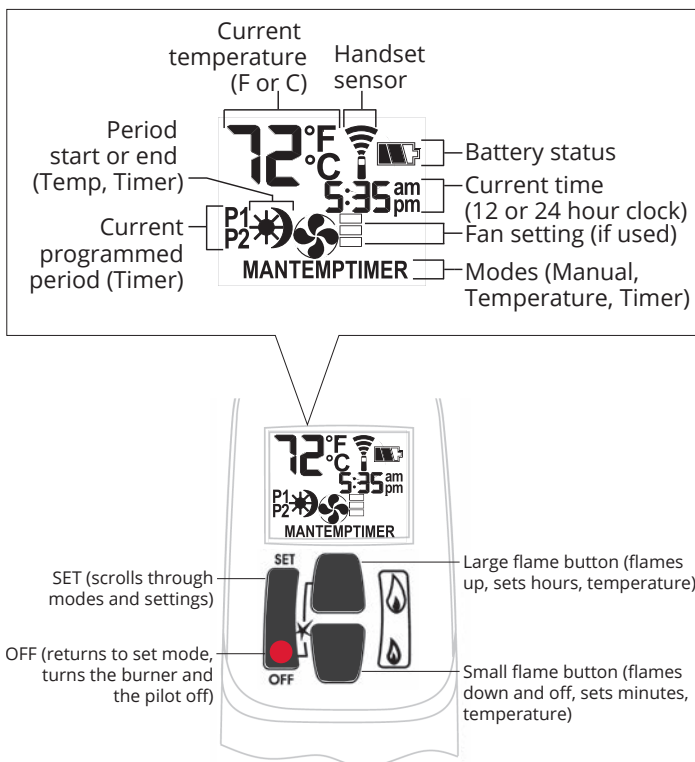

Turn Fireplace ON

Press ● + 🔥 buttons until you hear a short beep; release buttons.

Beeps continue until pilot is lit.

Burner lites to maximum flame height and handset goes automatically to manual (MAN) mode.

NOTES:

On the valve, MAN button must be at ON, in full counter-clockwise position ↺.

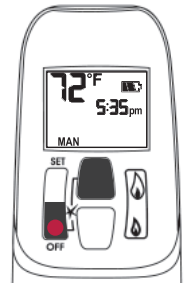

Turn Fireplace OFF

Press ● button.

When pilot is just turned off, wait 2 minutes to light it again.

Standby Mode (Pilot Flame)

Press and hold 🔥 to set fireplace to pilot.

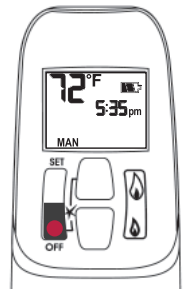

Adjust Flames Height

With pilot lit, press and hold buttons:

🔥 = increase flame height

🔥 = decrease flame height or set to pilot

For fine adjustment, tap buttons.

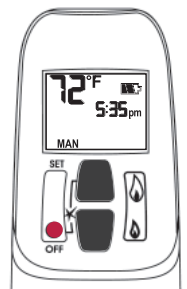

Express Low and High Fire

Double-click buttons:

🔥 = increase flame to maximum height "HI"

🔥 = decrease flame minimum height "LO"

NOTE: Flame goes to high fire first before going to designated low fire.

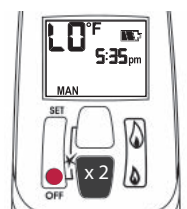
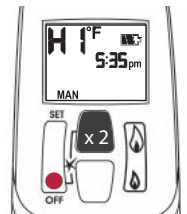

Appendix B-Remote Control Operation

Setting °C/24-hr or °F/12-hr clock

In MAN mode, press ● + 🔥 buttons until temperature / clock display changes from

°F / 12-hour ↔ °C / 24-hour

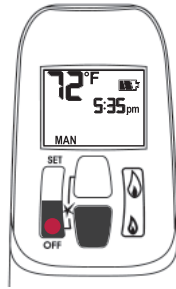

Setting Time

The time display will flash after either:

- installing the battery, or
- pressing 🔥 + 🔥

To set the time, press buttons:

🔥 = hour

🔥 = minutes

Press ● or wait to go back to MAN.

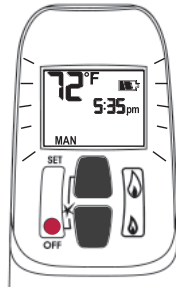

Modes of Operation

Briefly press SET cycles through modes of operation.

MAN > TEMP > Light > Fan >

TEMP > TIMER > MAN

NOTE: Press 🔥 or 🔥 to reach MAN mode.

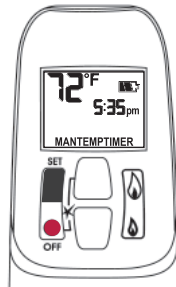

MAN Manual Mode

Manual flame height adjustment.



TEMP Daytime Temperature Mode

When pilot is lit, room temperature is measured and compared to set temperature. Flame height automatically adjust to reach Daytime Set Temperature.



Light Dimmer Mode

Not available on this fireplace.



Fan Mode

Turns fan ON and OFF and adjusts speed.



Note: To turn fan OFF, press 🔥 until all 4 bars disappear.

TEMP Night time Setback Temperature Mode

When pilot is lit, room temperature is measured and compared to set temperature. Flame height automatically adjust to reach Night Time Setback Temperature.

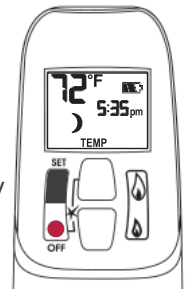

TIMER Timer Mode

When pilot is lit, two periods of time (P1 and P2) can be programmed to use Daytime and Night time temperatures at specific times.

Note: Display shows set temperature every 30 seconds.

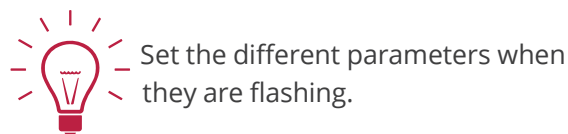
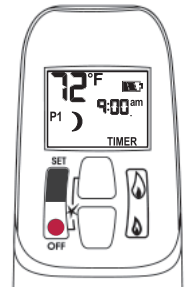

Appendix B-Remote Control Operation

Circulating Fan Operation (if equipped)

Circulating fan has 4 speed levels from low to high (1 to 4 bars).

Press SET to scroll to . Fan and level icons flash.

To set speed, press flame buttons:

= increases speed.

= decreases speed and turns OFF fan when all bars disappear.

Note: 8 seconds after the fan is set, handset goes automatically in temperature control mode. Fan starts 4 minutes after gas opens (from OFF or pilot) at maximum speed then goes to displayed level after 10 seconds. Fan stops 10 minutes after gas is OFF or at pilot.

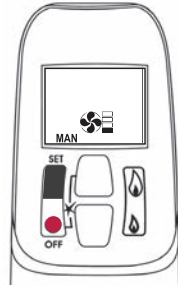

Setting Program Timers

You can program two periods of time between 12 am and 11:50 pm in each 24-hour cycle.

Programs P1 and P2 must be set in the following order during a 24-hour cycle: **P1** , **P1** , **P2** and **P2** .

= Day Time temperature (high) program period

= Night Time temperature (low) program period

Default Settings:

Program 1: **P1** 06:00 am **P1** 08:00 am

Program 2: **P2** 11:50 pm **P2** 11:50 pm

Press SET to scroll to **TIMER**.



If **P1** = **P1** or **P2** = **P2** , programming is cancelled.

To keep fireplace ON all night, set **P2** at 11:50 am and **P1** at 12:00 am.

If you want to program only one period, program **P1** and **P1** with desired times then **P2** and **P2** with the same time as **P1** .

Setting high / low Temperatures

Setting "DAYTIME" high temperature.

Default Settings: **TEMP** 23 °C/74 °F

Press SET to scroll to **TEMP**

Hold SET button until TEMP flashes.

To set Daytime Temperature:

= increases temperature.

= decreases temperature.

Press or wait to complete setting.

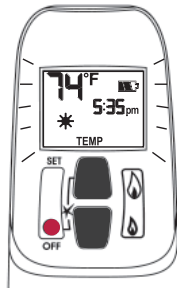

Setting P1 time - high temperature.

Hold SET button until **P1** is displayed and time flashes.

To set time:

= hour

= minutes

Press or wait to complete setting.

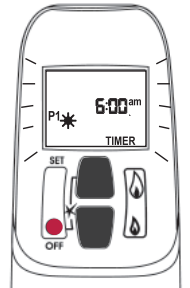

Setting "NIGHT TIME SETBACK" low temperature.

Default Settings: **TEMP** "--" (OFF)

Press SET to scroll to **TEMP**

Hold SET button until TEMP flashes.

To set Night Time Temperature:

= increases temperature.

= decreases temperature.

Press or wait to complete setting.

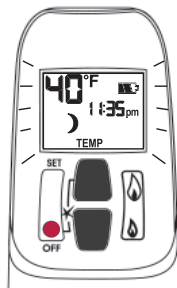

Setting P1 time - low temperature.

Hold SET button until **P1** is displayed and time flashes.

To set time:

= hour

= minutes

Press or wait to complete setting.

Appendix B-Remote Control Operation

Setting P2 high and low temperature times.

Repeat same steps as Setting P1.

When all settings are complete, press ● to save them.

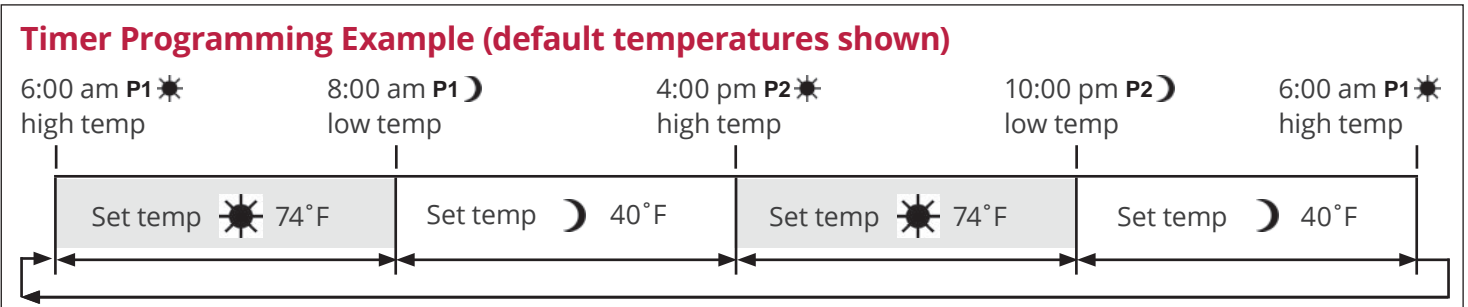

Automatic Turn Down

8 Hour no Motor Movement

The valve will turn to pilot flame if there is no motor movement for an 8-hour period.

Automatic Shut-Off

Low Batteries Receiver. With low battery power in the battery holder the system shuts off the fire completely. This does not apply when the power supply is interrupted.

On-Demand Pilot (7 Day Shut-Off). This green feature eliminates gas energy consumption during extended appliance inactivity. When the appliance is inactive for an extended period of time the system automatically extinguishes the pilot. This feature helps the consumer realize cost benefits by automatically eliminating energy consumption during non-heating months and limited use.

The programmed length of inactivity to activate the system is specified by the appliance manufacturer and cannot be altered in the field.

Low Battery Indication

Handset: The battery icon  will show when the battery needs to be replaced. Replace with one 9 V **alkaline**

⚠ Caution

DO NOT USE a screwdriver or other metallic object to remove batteries from holder. This could cause a short-circuit.

battery.

Battery holder: Frequent 'beeps' for 3 seconds when the valve motor turns indicate the batteries need to be replaced in battery holder. Replace with four 1.5 V **alkaline** batteries.

Handset / Receiver Match

The remote control handset and receiver are programmed to function together. In case of a replacement of the handset or the receiver, you will need to reset the receiver to allow them to function together. Contact your dealer for details.

Appendix C—Spare Parts

	Description	Part Number
1	Autofire vent plate assembly	4006540
2	Exhaust plate gasket	4001662
3	Valve access cover	4002289
4	Side brick anchors (2)	4001283
5	LH Explosion relief assembly	4001286
6	RH Explosion relief assembly	4001287
7	Valve access panel gasket	4002664
8	Valve access plate	4002510
9	Shrouds (2)	4002446
10	Contemporary burner platform	4004849
11	Window frame assembly (inc. glass)	4004463S
12	Hot glass warning plate	4003093
13	Burner module assembly (natural gas)	4004713
	Burner module assembly (propane gas)	4004714
14	Top gasket	4002403
15	Side gaskets (2)	4002404
16	Bottom gasket	4002405
17	Thermocouple/pilot sealing plate	4002700
18	Pipe sealing plate	4004338
19	Straight connector	220K891
20	Thermocouple interrupter	4001037
22	GV60 valve assembly (natural gas)	4004840S
	GV60 valve assembly (propane gas)	4004841S
23	36" flex pipe assembly	4002475
24	Main burner pipe assembly	4004047
25	Pilot shield	4004559AH
26	Pilot assembly 51 (natural gas)	4006019
	Pilot assembly 30 (propane gas)	4006020
27	Thermocouple (1000 mm)	4004801
28	Pilot injector #51 (natural gas)	4000735
	Pilot injector #30 (propane gas)	4000736
29	Pilot hood 2-flame	4001756
30	Extended nut	4001855
31	Electrode	4001856
32	Injector elbow #850 (natural gas)	9730010
	Injector elbow #300 (propane)	9730035
33	Injector nut	420K464

	Description	Part Number
34	Insulation sleeve for ignition cable	4002244
35	Ignition cable (900 mm)	4004800
36	Cable interrupter, red	4001035
37	Cable interrupter, yellow	4002096
38	Wiring harness	4001187
39	Receiver MAX	4002422
40	Auxiliary battery holder and cable	
a	Battery holder	4006553
b	Battery holder cable 1500 mm	4006552
41	Handset GV60 MAX	4002251
42	Remote control wall holder	9000008
43	Driftwood Kit	1101DWK
44	Logs & Pebbles Set	4004369
45	LH rear log	4004370
46	RH rear log	4004371
47	LH cross log	4004372
48	Brown beach pebbles (2)	4003082
49	White beach pebble	4003084
50	Black beach pebble	4003085
51	Small grey beach pebbles (2)	4003086
52	Beige beach pebble	4003087
53	Mixed black/grey shale - bagged	4004503
58	Decorative Glass Murano	785XDGM
59	Pilot shield cover	4004699AH
60	Glass pad	4004798
61	Glass platform	4004696
62	Platform retainers (2)	4004697AH
63	1/2" Clear fireglass (1 bag)	4004521
64	Liner panels—complete sets	
a	Ledgestone V3	786LSLV3
b	Reflective Glass	787RGL
c	Ceramic fluted black	788FBLV2
d	Valor red brick	789VRLV2
65	Top panel	
a	Ledgestone V3	4007997
b	Ceramic black	4002374
c	Ceramic black	4002374
d	Valor red brick	4002385

Appendix C–Spare Parts

	Description	Part Number
66	Rear panel	
a	Ledgestone V3	4008000
b	Reflective Glass	4004707
b	Rear filler panel	4004799
c	Ceramic fluted black	4004268
d	Valor red brick	4004266
67	Left side panel	
a	Ledgestone V3	4007998
b	Reflective Glass	4004708
b	Filler panel	4002776
c	Ceramic fluted black	4002377
d	Valor red brick	4002381
68	Right side panel	
a	Ledgestone V3	4007999
b	Reflective Glass	4004709
b	Filler panel	4002776
c	Ceramic fluted black	4002378
d	Valor red brick	4002383
69	GV60 Valve repair kit	4004544
70	2.5-4.5" hose clamps (2)	4000768

Appendix C-Spare Parts

