



LEGEND G4



Patent Pending

Direct Vent Gas Insert 785ILN (NG) & 785ILP (LPG) Installation and Owner's Manual

! WARNING



HOT GLASS WILL CAUSE BURNS.
DO NOT TOUCH GLASS UNTIL COOLED.
NEVER ALLOW CHILDREN TO TOUCH GLASS.

INSTALLER
Leave this manual with the appliance.

CONSUMER
Retain this manual for future reference.

A barrier designed to reduce the risk of burns from the hot viewing glass is provided with this appliance and shall be installed for the protection of children and other at-risk individuals.

Please read this manual **BEFORE** installing and operating this appliance.

WARNING: If the information in these instructions is not followed exactly, a fire or explosion may result causing property damage, personal injury or loss of life.

This manual contains instructions to install the **ENGINE ONLY**. A front is also **REQUIRED** to complete this installation. A barrier screen is provided with the front. **Refer to the manual supplied with the front for installation.**

Do not store or use gasoline or other flammable vapors and liquids in the vicinity of this or any other appliance.

This appliance may be installed in an after-market permanently located, manufactured (mobile) home where not prohibited by local codes.

WHAT TO DO IF YOU SMELL GAS

- Do not try to light the appliance.
- Do not touch any electrical switch; do not use any phone in your building.
- Immediately call your gas supplier from a neighbor's phone. Follow the gas supplier's instructions.
- If you cannot reach your gas supplier, call the fire department.

This appliance is only for use with the type of gas indicated on the rating plate. This appliance is not convertible for use with other gases, unless a certified kit is used.

This appliance is a domestic room-heating appliance. It must not be used for any other purposes such as drying clothes, etc.

Installation and service must be performed by a qualified installer, service agency or the gas supplier.

This appliance is suitable for installation in a bedroom or bed sitting room.

Ce guide est disponible en français sur demande.

Miles Industries Ltd.
www.valorfireplaces.com



Table of Content

FOR THE OWNER

Safety Precautions	3
Safety and Your Fireplace	4
Owner's Information	5
Remote Control Operation.....	9
Options	14
Lighting Instructions.....	15
Warranty	37

Warranty Card at the back of this manual.



Massachusetts: The piping and final gas connection must be performed by a licensed plumber or gas fitter in the State of Massachusetts.

FOR THE QUALIFIED INSTALLER

Specifications	16
Overview.....	17
Dimensions.....	18
Cavity.....	18
Clearances	19
Venting.....	20
Installation Planning	21
Existing Fireplace Preparation.....	21
Appliance Preparation	22
Supply Gas Installation.....	25
Burner Removal and Reinstall.....	27
Ceramic Panels Installation	27
Ceramic Logs Installation	28

Window Refitting.....	31
Remote Control Initial Set-up	32
Operation Check & Aeration Settings Adjustment.....	33
Side Shrouds Installation.....	34
Front, Trim and Barrier Screen Installation	34
Remote Control Handset Wall Holder Installation	34
Wiring Diagram.....	35
Approved Venting Components.....	36
Warranty	37
Spare Parts.....	38



We recommend that our gas hearth products be installed and serviced by professionals who are certified in the U.S. by the National Fireplace Institute® (NFI) as NFI Gas Specialists.

www.nficertified.org

The information contained in this installation manual is believed to be correct at the time of printing. Miles Industries Ltd. reserves the right to change or modify any information or specifications without notice. Miles Industries Ltd. grants no warranty, implied or stated, for the installation or maintenance of your heater, and assumes no responsibility for any consequential damage(s).

Designed and Manufactured by / for
Miles Industries Ltd.
 190–2255 Dollarton Highway, North Vancouver, BC, CANADA V7H 3B1
 Tel. 604-984-3496 Fax 604-984-0246
www.valorfireplaces.com
 © Copyright Miles Industries Ltd., 2013



Safety Precautions

READ and **UNDERSTAND** all instructions carefully before starting the installation. **FAILURE TO FOLLOW** these installation instructions may result in possible fire hazard and will void the warranty.

Prior to the first firing of the fireplace, **READ** the Owner's Information section of this manual.

DO NOT USE this appliance if any part has been under water. Immediately, **CALL** a qualified service technician to inspect the unit and to replace any part of the control system and any gas control that has been under water.

THIS UNIT IS NOT FOR USE WITH SOLID FUEL.

Installation and repair should be **PERFORMED** by a qualified service person. The appliance and venting system should be **INSPECTED** before initial use and at least annually by a professional service person. More frequent cleaning may be required due to excessive lint from carpeting, bedding, etc. It is **IMPERATIVE** that the unit's control compartment, burner, and circulating air passageways **BE KEPT CLEAN** to provide for adequate combustion and ventilation air.

Always **KEEP** the appliance clear and free from combustible materials, gasoline, and other flammable vapors and liquids.

NEVER OBSTRUCT the flow of combustion and ventilation air. Keep the front of the appliance **CLEAR** of all obstacles and materials for servicing and proper operation.

Due to the high temperature, the appliance should be **LOCATED** out of traffic areas and away from furniture and draperies. Clothing or flammable material **SHOULD NOT BE PLACED** on or near the appliance.

Clothing or flammable material **SHOULD NOT BE PLACED** on or near the appliance.

Children and adults should be **ALERTED** to the hazards of high surface temperature and should **STAY AWAY** to avoid burns or clothing ignition.

YOUNG CHILDREN should be **CAREFULLY SUPERVISED** when they are in the same room as the appliance. Toddlers, young children and others may be susceptible to **ACCIDENTAL CONTACT BURNS**. A physical barrier is recommended if there are at risk individuals in the house. To restrict access to a fireplace or stove, **INSTALL AN ADJUSTABLE SAFETY GATE** to keep toddlers, young children and other at risk individuals out of the room and away from hot surfaces.

This unit **MUST** be used with a vent system as described in this installation manual. **NO OTHER** vent system or components **MAY BE USED**.

This gas fireplace and vent assembly **MUST** be vented directly to the outside and **MUST NEVER** be attached to a chimney serving a separate solid fuel burning appliance. Each gas appliance **MUST USE** a separate vent system. Common vent systems are **PROHIBITED**.

INSPECT the external vent cap on a regular basis to make sure that no debris, plants, trees, shrubs are interfering with the air flow.

The glass door assembly **MUST** be in place and sealed before the unit can be placed into safe operation.

DO NOT OPERATE this appliance with the glass door removed, cracked, or broken. Replacement of the glass door should be performed by a licensed or qualified service person. **DO NOT** strike or slam the glass door.

The glass door assembly **SHALL ONLY** be replaced as a complete unit, as supplied by the fireplace manufacturer. **NO SUBSTITUTE** material may be used.

If the barrier becomes damaged, the barrier **SHALL BE REPLACED** with the **MANUFACTURER'S BARRIER** for this appliance.

DO NOT USE abrasive cleaners on the glass door assembly. **DO NOT ATTEMPT** to clean the glass door when it is hot.

TURN OFF the gas before servicing this appliance. It is recommended that a qualified service technician perform an appliance check-up at the beginning of each heating season.

Any safety screen, guard or barrier removed for servicing the appliance, **MUST BE REPLACED** prior to operating the appliance.

DO NOT place furniture or any other combustible household objects within 36" of the fireplace front.

BE CAREFUL not to put any decorating objects sensitive to heat to close above or around the fireplace as it gets very hot when operating.

DO NOT use this heater as a temporary source of heat during construction.

This appliance is a **DOMESTIC ROOM-HEATING APPLIANCE**. It must not be used for any other purposes such as drying clothes, etc.

State of California. Proposition 65 Warning. Fuels used in gas, wood-burning or oil fired appliances, and the products of combustion of such fuels, contain chemicals known to the State of California to cause cancer, birth defects and other reproductive harm. California Health & Safety Code Sec. 25249.6.

Safety and Your Fireplace

Please Read and Carefully Follow all Safety Warnings and Operating Instructions Contained in Your Owners Manual

(Replacement Manuals are available by contacting our service department at 1-800-468-2567 or visit www.valorfireplaces.com).

Please Follow These Important Child Safety Precautions and Recommendations,

- Parts of your Valor Fireplace become **extremely hot** while in operation.
- The glass viewing **window temperature can exceed 500 F** at full capacity. Momentary contact with a hot glass surface can **cause a severe burn**, even if the fireplace is operating at reduced heating capacity.
- **The glass window will remain hot** for an extended period of time after the fireplace has been turned off. Ensure that children are prevented from touching the fireplace during the cool down period.
- **Toddlers and Young Children must be closely supervised at all times** when they are in the same room as the operating fireplace. They lack full awareness of danger and rely on your protection. Toddlers, in particular, do not have the motor skills and response reflexes to



withdraw in the event of accidental contact with a hot surface.

- **A physical barrier is strongly recommended** if there are young children, or at-risk individuals in the house. Install an approved after-market safety gate to keep toddlers, young children and other at-risk individuals a safe distance from the fireplace.
- **Keep the remote control handset out of reach of children at all times.** A wall mount storage holster is provided with your remote control handset.
- **Ensure that the fireplace, including the pilot light, is completely turned off** when children are present and close supervision and safety barriers are not available—see page 8 of *Owner's Information* section.
- If the fireplace is not going to be used for the summer or any extended period of time, **remove the batteries from the remote control handset and receiver.** It is recommended that batteries are replaced annually in any event—see page 7.

⚠ WARNING

EXTREMELY HOT!!!

- **READ the SAFETY information on pages 3 and 4 of this manual BEFORE operating your gas heater.**
- Some parts of your fireplace are **EXTREMELY HOT**, particularly the **GLASS** window.
- **DO NOT LET CHILDREN** touch the glass or any parts of your fireplace **even after it is turned off** as it is still hot.
- **USE THE BARRIER SCREEN** provided with the front or trim or a **GATE** to reduce the risk of burns.
- Keep the remote control handset **OUT OF REACH** of children.
- **HOT HEARTH / FLOOR!** The hearth or floor in front of the fireplace may become very hot when the fireplace heats. Do not use the hearth as a seat or shelf.
- Some materials or items, although safe, may discolor, shrink, warp, crack, peel, and so on because of the heat produced by the fireplace. **AVOID PLACING** candles, paintings, photos, and other items **SENSITIVE TO HEAT** within 36 inches (0.9 m) around the fireplace.
- Solid wood flooring in front of the fireplace (if allowed) may shrink during the heating season due to heat.

Performance of LPG appliances may be affected by the quality of commercial gas supplied in your area.

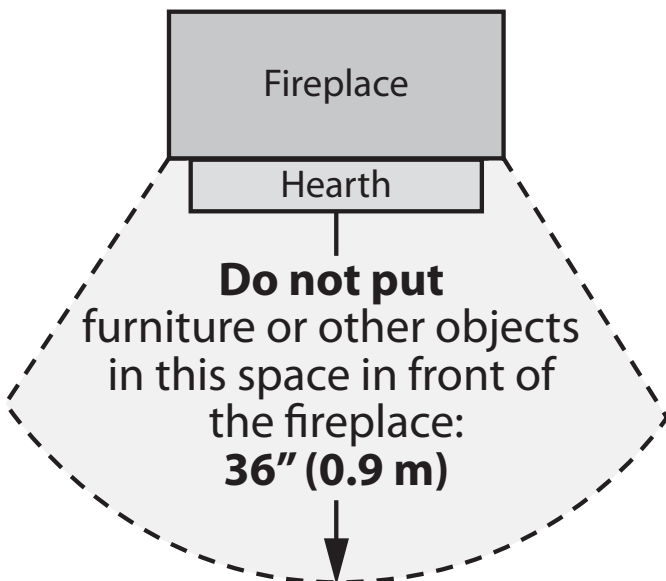

Thank You ...

For purchasing a Valor by Miles Industries. Your new radiant gas heater is a technical appliance that must be installed by a qualified dealer. Each Valor fireplace is fully tested during the production process for your safety and comfort.

Your unit has been professionally installed by:

Dealer Name: _____

Phone Number : _____

Should you encounter an operational problem, call your dealer immediately.

Do not try to repair the unit as you may cause an injury or damage the fireplace.

This manual and particularly the preceding and following pages contain very important information regarding the safe operation of your fireplace as well as maintenance instructions. Read carefully BEFORE operating your fireplace and pay special attention to the SAFETY WARNINGS.

A heating gas appliance does require safe handling and for this reason, we very strongly recommend that no children be allowed to touch the fireplace and its controls at all times. **Do install a screen or barrier in front of the fireplace to protect your children against severe burns.**

Operating Your Fireplace for the First Time

When operating your new fireplace for the first time, some vapors may be released due to the burning of curing compounds used in the manufacture of the appliance. They may cause a slight odor and could cause the flames to be the full height of the firebox, or even slightly higher, for the first few hours of operation. It is also possible that these vapors could set off any smoke detection alarms in the immediate vicinity. These vapors are quite normal on new appliances. We recommend opening a window to vent the room. After a few hours use, the vapors will have disappeared and the flames will be at their normal height.

Flame Supervision Device

For your safety, this appliance is fitted with a flame supervision device which will shut-off the gas supply if, for any reason, the pilot flame goes out. This device incorporates a fixed probe, which senses the heat from the pilot flame. If the probe is cool, the device will prevent any gas flow unless manually lighting the pilot. See full lighting instructions on page 15 of this manual.

Cleaning

⚠ WARNING

DO NOT TOUCH THE GLASS WHILE IT IS HOT!
Let the fireplace cool first before cleaning it.

Important - Glass cleaning - Mineral deposits

One of the by-products of the combustion process in a gas appliance is a mineral which can show up as a white film on the ceramic glass of the viewing door. The composition of the deposit varies widely from various locations and also from time to time in the same location. It seems this is associated with the varying sulfur content of the gas. You may have the problem for a time and then not see it for many months when it will reappear in your area.

We have discussed this problem with ceramic glass manufacturers and they cannot give us a definitive answer to this problem. Dealers have tried various cleaning products with varying results. The following recommendations will not guarantee results in your particular case.

NOTE: This is a problem beyond Miles Industries' control and is not covered under warranty.

- Clean the glass regularly as soon as you notice the buildup (white film). If the film is left for a longer period of time, it will bake on. It is then much harder, if not impossible, to remove.
- NEVER use an abrasive cleaner on the ceramic glass. Any abrasion of the surface has the immediate effect of compromising the strength of the glass. An emulsion type cleaner is recommended.
- Use a soft damp cloth to apply the cleaner. Dry the glass with a soft, dry, preferably cotton cloth. Most paper towels and synthetic materials are abrasive to ceramic glass and should be avoided.
- Our dealers have had good results from the products listed below. We cannot, however, guarantee the results of these products.
 - » BRASSO, POLISH PLUS by KELKEM, COOK TOP CLEAN
 - CREME by ELCO, WHITE OFF by RUTLAND, TURTLE WAX

Do not clean the glass while it is hot!

Always securely replace the window and the barrier screen before lighting.

If broken, the glass pane may only be replaced as a complete window unit as supplied by the manufacturer.

If the barrier becomes damaged, the barrier shall be replaced with the manufacturer's barrier for this appliance.

To remove the window:

1. Unhook the trim with the barrier screen.
2. Remove the side access doors as indicated.
3. Find the levers on each side of the window towards the top. Using your finger, pull the levers towards you and unhook them from the window frame brackets.
4. Gently pull the top of the window outward.
5. Lift the window out of its bottom railing and set it aside in a safe place to avoid damage.

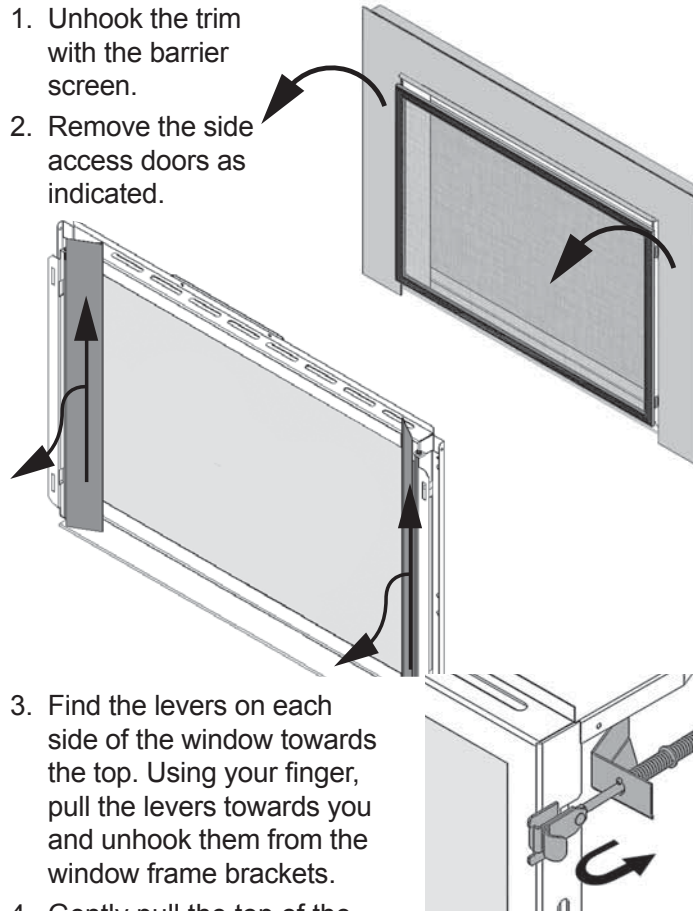

Clean the window following the guidelines in this section. Clean the trim and front with mild soap and water. Dust the barrier screen with a soft brush. Dust the firebox ceramic logs/rocks and walls with a soft brush. Dust can also be removed from the burner using a soft brush after removing the ceramic logs. **When cleaning, make sure that no particles are brushed into the slots of the burner.**

To refit the window:

1. Place it in its bottom railing and push its top against the firebox.
2. While you hold it, pull the side levers back into the window brackets on each side.

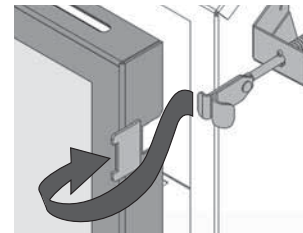

IMPORTANT: To ensure a safe operation, verify that the levers are hooked properly to the window tabs; then, pull out the top of the window and release it to insure the springs return it.

Owner's Information

3. Apply light hand pressure against the window frame sides to bed-in the window seal.
4. **If the Hot Glass Warning plate has been removed from the front lower corner of the window, reinstall it by sliding it between the glass and the frame as indicated.**

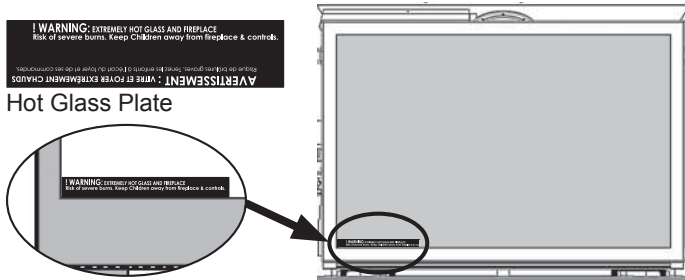

5. Reinstall the access side doors to the fireplace.
6. Rehook the front trim fitted **with the barrier screen**.

! WARNING

FOR SAFETY PURPOSE, ensure the barrier screen is re-installed on the fireplace front after maintenance.

Checks

A periodic check of the pilot and burner flames should be made. Check after the fire has been on for at least 30 minutes. The pilot flame must cover the tip of the thermocouple probe. The main burner flame pattern will vary from appliance to appliance depending on the type of installation and climatic conditions.

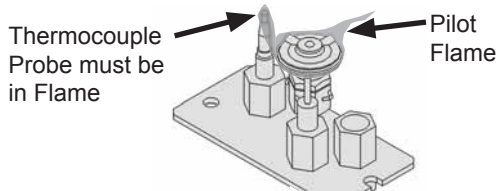
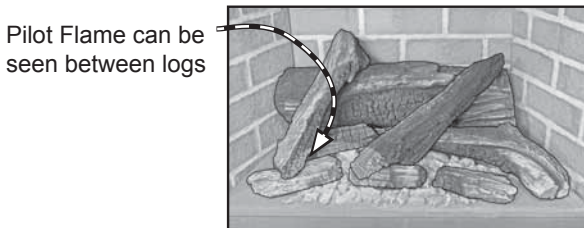

The appliance area must always be kept clear and free from combustible materials, gasoline and other flammable vapors and liquids.

Inspect the vent terminal outdoors regularly to make sure that snow, trees, bushes, leaves, or other objects do not obstruct it.

Examine the vent system and terminal regularly. We recommend annually.

Batteries

! WARNING

DO NOT ATTEMPT TO CHANGE THE BATTERIES WHILE THE FIREPLACE IS STILL HOT! Let the fireplace cool first before touching it.

CAUTION

DO NOT USE a screwdriver or other metallic object to remove the batteries from the receiver or the handset! This could cause a short circuit to the receiver.

Low batteries signal: see page 14.

BEFORE changing the batteries, disconnect the battery box from the receiver.

The appliance uses four 1.5 V AA **alkaline** batteries for its battery box and one 9 V **alkaline** battery for its handset. Batteries should last one to two seasons, depending on usage. Removing the batteries in the off-season will extend the battery life. Should the batteries loose power, the control may be operated by manually turning the control knob at the valve or by turning off the valve at the switch.

To replace the batteries in the battery box:

1. The battery box is located to the left of the firebox behind the left access door. Remove the left access door. Grab the battery box and pull it out from its location.
2. Disconnect the battery box.

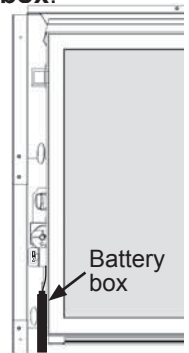

3. Remove the box cover (1 screw).
4. Replace the batteries with 4 AA **alkaline** batteries.

5. Replace the cover and screw in place.
6. Reconnect the battery box.
7. Put the battery box back in its position.
8. Reinstall the left access door.

Remote Control Handset Wall Holder

Your fireplace equipment includes a wall holder to store the handset. If it hasn't been installed, refer to the instructions further on in this manual for the installation.



Servicing

If any attention is required for your appliance, contact your supplier quoting the model number. It will be helpful if the appliance's serial number can also be quoted. This number is on the rating plate, which is located at the right of the firebox. The replacement parts are shown at the end of this manual. Please always quote the part number and description when requesting spare parts.

Lighting, Operation and Rating Information

⚠ WARNING

DO NOT ATTEMPT TO TOUCH THE DATA PLATE WHILE THE FIREPLACE IS STILL HOT! Let the fireplace cool first before touching it.

The Lighting, Operation and Rating information is located on a plate at the right of the firebox. To access the plate, remove the right hand side door, grab the plate and take it out to read it. There is important information on both sides of the plate.

Fireplace Control Devices

There are three ways to control your fireplace.

1. Thermostatic Remote Control;
2. Wall Switch (optional);
3. Manual On/Off Switch.

The manual On/Off switch must be ON for the fireplace to function. It can be used to shut off the fireplace in case of emergency—see next sub-section.

The Thermostatic Remote Control can be programmed to function automatically—see pages 9–14.

The Wall Switch (optional) can be used to turn on, off and to increase or decrease the flame height—see 1265WSK—Wall Switch Kit.



Thermostatic Remote Control

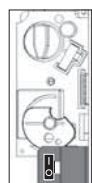

Manual On/Off Switch



Wall Switch (optional)

NOTE: The remote control in the AUTO mode will override the wall switch.

How to Turn Your Fireplace OFF (including pilot)

Familiarize yourself with each of these methods before operating your fireplace.

Handset and Wall Switch: Press and hold the OFF button for a second.

If the flames are on, they go down and you hear the valve motor wind down. You hear a clunk and a beep indicating that the valve has received the signal from the remote control.

Manual ON/OFF Switch: Press the **O** button.

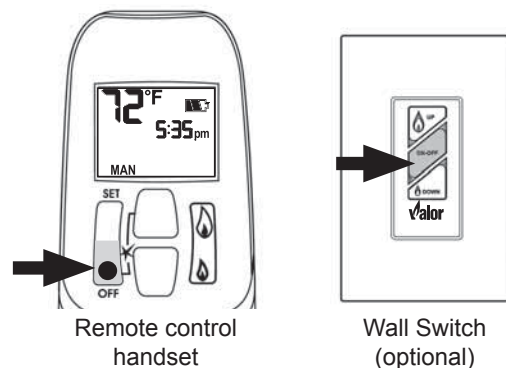

Remote control handset

Wall Switch (optional)

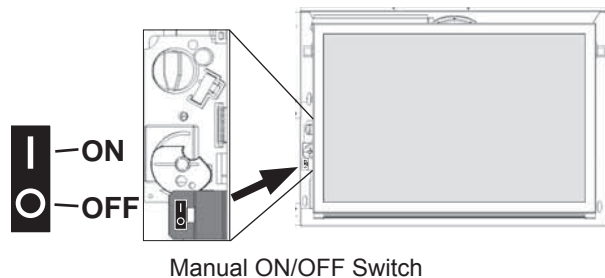

Manual ON/OFF Switch

How to Ensure Your Fireplace Cannot Be Turned ON Inadvertently

You can use one of the two following methods to ensure that your fireplace will not turn on when you don't want it on.

First, ensure your fireplace is turned off—including the pilot—and cold BEFORE going ahead.

- Press the **O** button on the manual ON/OFF switch on the gas valve—see image above.
- Alternately, remove all batteries from the receiver as well as the battery from the handset.

Automatic Shut-Off (in certain conditions)

Your fireplace's remote control is equipped with an automatic shut-off mechanism which is activated in certain conditions. See page 14 in the *Remote Control Operation* section for a description of this feature.

Remote Control Operation

NOTE: Before using the remote control system for the first time, the receiver and the handset must be synchronized. See the section *Remote Control Initial Set-up* on page 32 of this manual.

IMPORTANT: BEFORE YOU BEGIN, please note that on this system, the settings of time, temperature and automatic ON/OFF **can only be programmed when the function display is flashing**. Be patient when programming as it can take a few seconds to set.

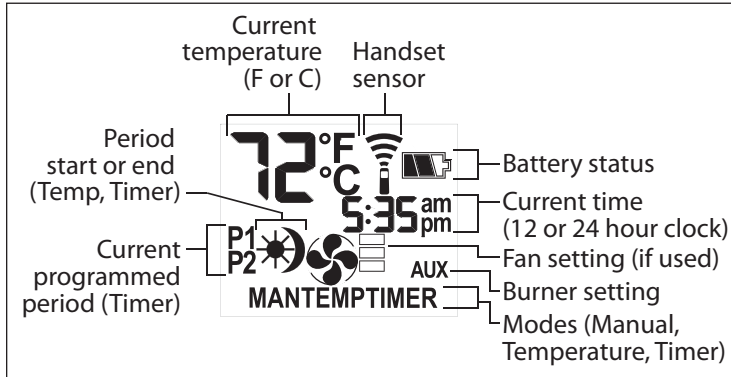

Display Overview

Note: In the TEMP or TIMER modes, the remote handset senses the room temperature and adjusts the flame accordingly.

To communicate, the handset should be within 15 feet (4.5 meters) of the fireplace.

Do not leave the handset on the mantel or hearth.

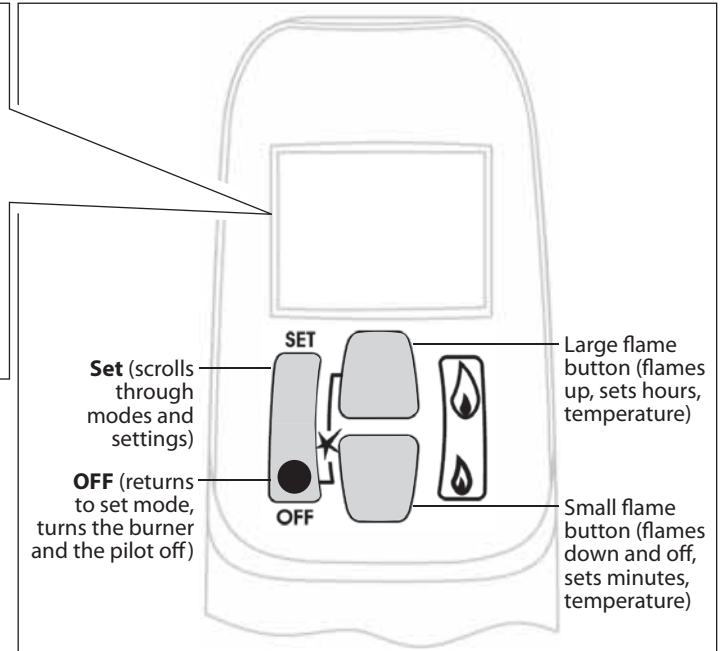

Handset Overview

TO TURN ON APPLIANCE

CAUTION

When pilot ignition is confirmed, motor turns automatically to maximum flame height.

- On the valve, turn MAN knob on the ON, full counterclockwise ↺ position.
- Place ON/OFF switch (if equipped) in I (ON position).

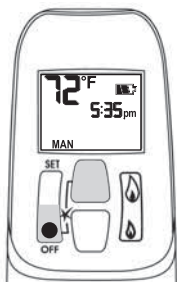

- Simultaneously press the OFF and 🔥 (large flame) buttons until a short beep confirms the start sequence has begun; release buttons.
- Continuing beeps confirm the ignition is in process.
- Once pilot ignition is confirmed, there is main gas flow.
- After main burner ignition the handset will automatically go into manual (MAN) control mode.

TO TURN OFF APPLIANCE

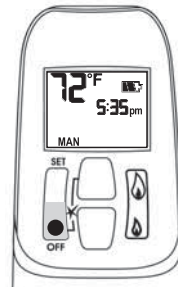

- Press OFF button.

When the pilot is off, it will take 2 minutes before it can be lit again.

STANDBY MODE (Pilot Flame)

- Press and hold 🔥 (small flame) to set appliance at pilot flame.

FLAME HEIGHT ADJUSTMENT

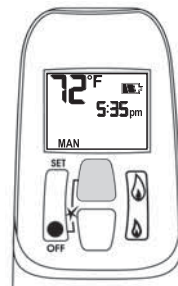

- In standby mode: Press and hold 🔥 (large flame) button to increase flame height.

Remote Control Operation

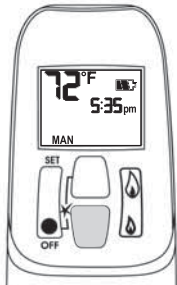

- Press and hold (small flame) button to decrease flame height or to set the appliance at pilot flame.
- For fine adjustment tap the (large flame) or (small flame) buttons.

Express Low and High Fire



- Double-click (small flame) button. "LO" will be displayed.
NOTE: Flame goes to high fire first before going to designated low fire.

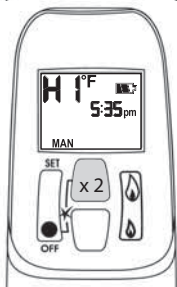

- Double-click (large flame) button. Flame automatically goes to high fire. "HI" will be displayed.

SETTING °C/24-HOUR OR °F/12-HOUR CLOCK



- In MAN mode, press OFF and (small flame) buttons until display changes from Fahrenheit/12-hour clock to Celsius/24-hour clock and vice versa.

SETTING THE TIME

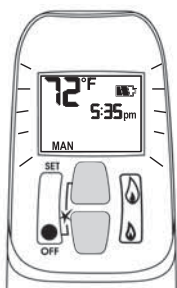

- The time display will flash after either:
 - » Installing the battery or
 - » Simultaneously pressing the (large flame) and (small flame) buttons.
- Press (large flame) button to set the hour.
- Press (small flame) button to set the minute.
- Press OFF or simply wait to return to MAN mode.

MODES OF OPERATION

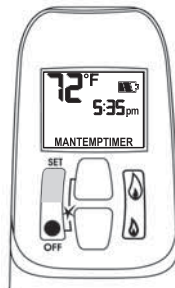

- Briefly pressing the SET button changes the mode of operation in the following order:

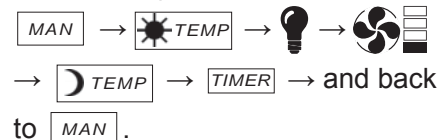

NOTE: Manual mode can also be reached by pressing either the (large flame) or the (small flame) buttons.

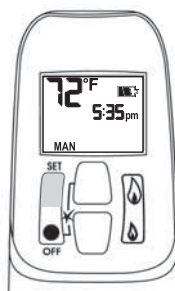

- - **Manual Mode** - Manual Flame Height Adjustment.

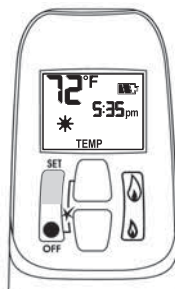

- - **Daytime Temperature Mode** (Appliance must be in standby mode; pilot ignited) - The room temperature is measured and compared to the set temperature. The flame height is then automatically adjusted to achieve the Daytime Set Temperature.

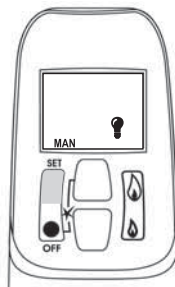

- - **Light/Dimmer Setting Mode**
Not available on this fireplace.

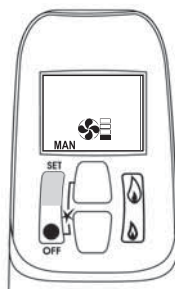

- - **Fan Mode** - Turns fan ON and OFF and adjusts fan speed.

NOTE: To turn OFF fan press (small flame) until all 4 speed level bars disappear.

Remote Control Operation

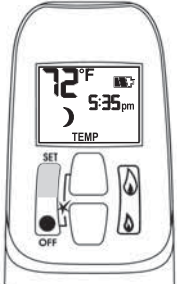

-  **- Nighttime Setback Temperature Mode** (Appliance must be in standby mode; pilot ignited) - The room temperature is measured and compared to the Nighttime Setback temperature. The flame height is then automatically adjusted to achieve the Nighttime Setback Temperature.

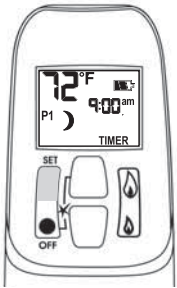

-  **- Timer Mode** (Appliance must be in standby mode; pilot ignited) - The timers P1 and P2 (Program 1, Program 2) each can be programmed to go ON and OFF at specific times. For instructions see Timer Programming Mode.





NOTE: The display shows the set temperature every 30 seconds.

CIRCULATING FAN OPERATION (if equipped)

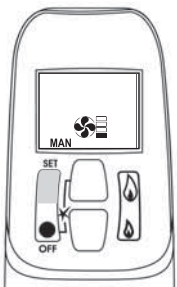

- Circulating Fan - The circulating fan has 4 speed levels from low (1 bar) to high (4 bars).



- Briefly press SET button to scroll to  (fan) mode. Fan and Level icons flash.
- Press  (large flame) button to switch ON and increase fan speed.
- Press  (small flame) button to decrease fan speed. To turn OFF fan, press  (small flame) button until all 4 speed level bars disappear.

NOTE: 8 seconds after the fan has been set, the handset will automatically go into temperature control mode. The fan starts 4 minutes after the gas opens (from OFF or from pilot) at maximum speed and goes to the displayed level after 10 seconds. The fan stops 10 minutes after the gas is OFF or at pilot.

TO OPEN AND CLOSE DOUBLE BURNER (785 fireplace models only)

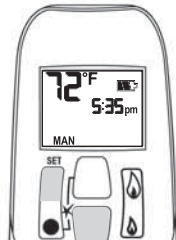

NOTE: The rear part of the double burner cannot be activated manually: it can only function with the remote control. However, if the battery runs down, the rear part of the burner will run according its the last operating position. During normal operation when lit with the remote control, both parts of the burner turn on regardless of the setting during the last use of the fireplace.

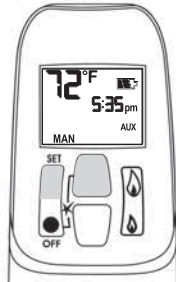

Rear burner
OFF



Rear burner
ON

- Upon ignition both parts of the burner are ON.
- Simultaneously press SET and  (small flame) buttons to switch the rear burner OFF. Printed instructions are on the handset's battery cover.
- Simultaneously press SET and  (large flame) buttons to switch rear part of the burner on. The AUX symbol on the handset display indicates that the rear part of the burner is ON.

NOTE: The function AUX is blocked in programming mode (TIMER, P1 or P2) when the Nighttime Setback Temperature  is set at --.



Double burner ON/
OFF commands
diagram at the rear
of the handset

Tip

Set the different parameters when they are flashing.

Remote Control Operation

SETTING THE ON / OFF TEMPERATURES

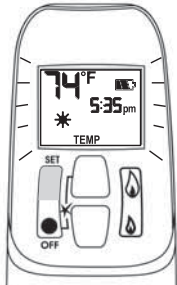

SETTING THE "DAYTIME" TEMPERATURE

Default Settings:  TEMP (sun), 23°C / 74°F



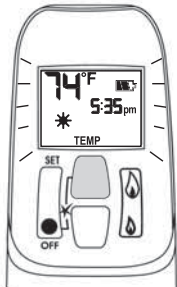

- Briefly press SET button to scroll to TEMP  TEMP (sun) mode. Hold the SET button until the TEMP flashes.

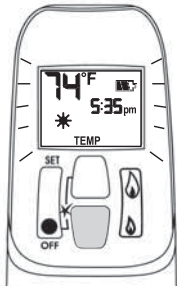

- Press  (large flame) button to increase the  Daytime Set Temperature.



- Press  (small flame) button to decrease  Daytime Set Temperature.

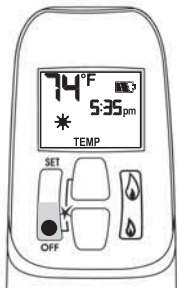

- Press OFF or simply wait to complete programming.

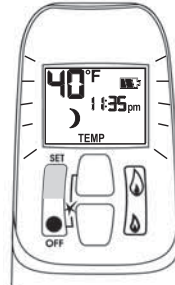

SETTING THE "NIGHTTIME SETBACK" TEMPERATURE

Default Settings:  TEMP (moon), "--" (OFF)



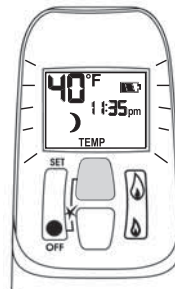

- Briefly press SET button to scroll to TEMP  TEMP (moon) mode. Hold the SET button until the TEMP flashes.

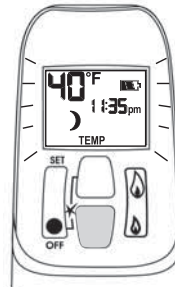

- Press  (large flame) button to increase  Nighttime Setback Temperature.



- Press  (small flame) button to decrease  Nighttime Setback Temperature.

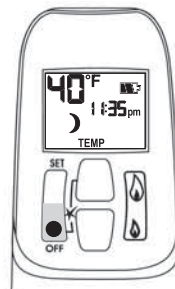

- Press OFF or simply wait to complete programming.

Remote Control Operation

SETTING PROGRAM TIMERS

- You can program two periods of time between 12:00 am and 11:50 pm in each 24-hour cycle.
- The Programs P1 and P2 must be set in the following order during a 24-hour cycle: **P1** ☀, **P1** 🌙, **P2** ☀ and **P2** 🌙
- The icon ☀ indicates the beginning of the period (ON) and the icon 🌙 indicates the end of the period (OFF).
- If **P1** ☀ = **P1** 🌙 or **P2** ☀ = **P2** 🌙, the programming is cancelled.
- To keep the fireplace ON all night, set **P2** 🌙 at 11:50 am and **P1** ☀ at 12:00 am.

Default settings:

Program 1: **P1** ☀ 6:00 am **P1** 🌙 8:00 am

Program 2: **P2** ☀ 11:50 pm **P2** 🌙 11:50 pm



- Briefly press SET button to scroll to TIMER mode.

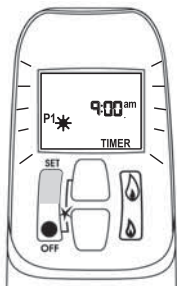

SETTING P1 ON TIME

- Hold the SET button until **P1** ☀ (sun) is displayed and the time flashes.

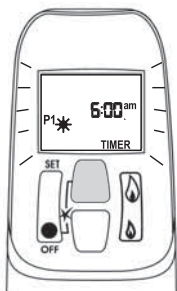

- Press 🔥 (large flame) button to set the hour.

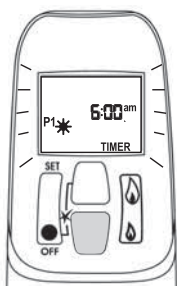

- Press 🔥 (small flame) button to set the minutes.

SETTING P1 OFF TIME

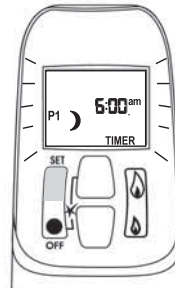

- Briefly press SET button to scroll to TIMER **P1** 🌙 (moon) while the time flashes.

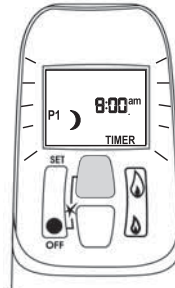

- Press 🔥 (large flame) button to set the hour.

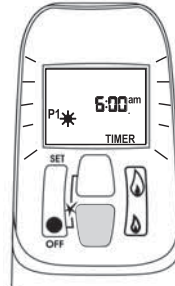

- Press 🔥 (small flame) button to set the minutes.

SETTING P2 ON TIME

- Briefly press SET to scroll to TIMER mode **P2** ☀ (sun) while the time flashes.
- Follow the instructions given to set P1 ON time.

SETTING P2 OFF TIME

- Briefly press SET to scroll to TIMER mode **P2** 🌙 (moon) while the time flashes.
- Follow the instructions given to set P1 OFF time.

Press OFF button to save these settings. The timers are programmed. See the diagram on programming sequences on the following page.

Tip

If you want to program only one period, program **P1** ☀ and **P1** 🌙 with desired times and program **P2** ☀ and **P2** 🌙 with the same time as **P1** 🌙.

Remote Control Operation

Timer Programming Example (default temperatures shown)

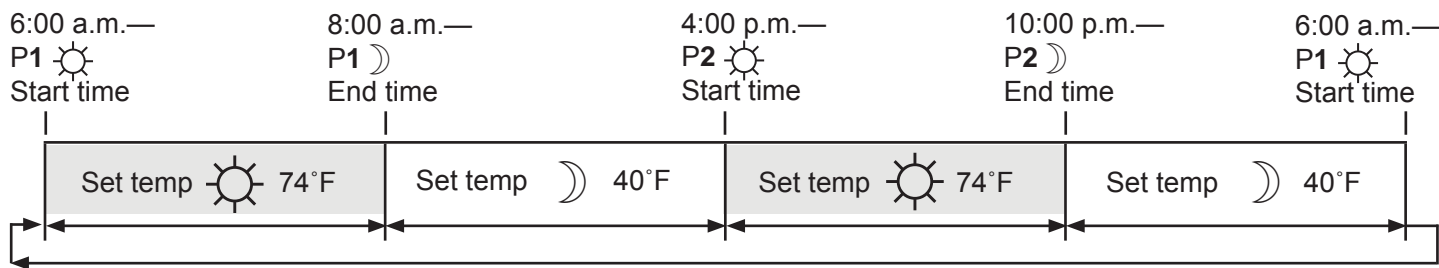

AUTOMATIC TURN DOWN

- **No communication.** If there is no communication between the receiver and the handset for a period of 6 hours, the appliance goes into pilot mode.
- **No change in flame height.** If there is no change in flame height for a period of 6 hours, the appliance goes into pilot mode.

NOTE: In **TEMP** or **TIMER** modes, the flame height will vary according to room temperature. The appliance will continue to work normally. However, if the room temperature remains the same for 6 hours, the appliance will go into pilot mode.

AUTOMATIC SHUT OFF

- **Low batteries in the receiver.** With low battery power in the receiver the system shuts off completely.
NOTE: This does not apply when the power supply is interrupted.
- **No change in pilot.** The appliance shuts off completely when it is continually in pilot position—without any change—for a period of 5 days.

LOW BATTERY INDICATION

CAUTION

DO NOT USE a screwdriver or other metallic object to remove the batteries from the battery box or the handset! This could cause a short circuit.

Remote handset: The battery icon  will show when the battery needs to be replaced. Replace with one 9 V **alkaline** battery.

Receiver: Three short 'beeps' will sound when the motor turns when the batteries need to be replaced. Replace with four 1.5 V **alkaline** batteries.

HANDSET / RECEIVER MATCH

The remote control handset and receiver are programmed to function together. In case of a replacement of the handset or the receiver, you will need to reset the receiver to allow them to function together. Contact your dealer for details.

Options

Required Kits*

Venting

See approved venting accessories listed on page 39.

Liner

786LSL—Ledgestone Liner Set
787EBL—Enamel Black Liner Set
788FBL—Fluted Black Liner Set
789VRL—Valor Red Brick Liner Set

Front (all with Barrier Screen 4003371)

790FTV—Floating Trim Kit Vintage Iron (2-1/2")
791STB—Square Trim Kit Black (5-3/4")
791STV—Square Trim Kit Vintage Iron (5-3/4")
792FTV—Floating Trim Kit Vintage Iron (5")
792FTZ—Floating Trim Kit Bronze (5")
798—Floating Trim Kit

Optional Accessories*

793RTB—Riser Black (2-1/2")
793RTV—Riser Vintage Iron (2-1/2")
794TBB—Trimmable Backing Plate Black 31" x 46"
795CFK—Circulating Fan Kit
796ALP—Adjustable Leveling Platform
1265WSK—Wall Switch Kit

Conversion Kit

785PGK—Conversion Kit to Propane Gas
785NGK—Conversion Kit to Natural Gas

Hearth Gate

Hearth gates such as Cardinal's VersaGates are available at retail stores carrying safety products for children.

*Information accurate at the time of printing and subject to change without notice.

Lighting Instructions

FOR YOUR SAFETY, READ BEFORE LIGHTING

WARNING: If you do not follow these instructions exactly, a fire or explosion may result causing property damage, personal injury or loss of life.

- A. This appliance has a pilot which must be lighted by hand or by remote control. Follow these instructions exactly. To save gas, turn the pilot off when not using the appliance for a prolonged period of time.
- B. **BEFORE LIGHTING**, smell all around the appliance area for gas. Be sure to smell next to the floor because some gas are heavier than air and will settle on the floor.
- WHAT TO DO IF YOU SMELL GAS
- Do not try to light any appliance.
 - Do not touch any electric switch; do not use any phone in your building.
 - Immediately call your gas supplier from a neighbor's phone. Follow the gas supplier's instructions.
 - If you cannot reach your gas supplier, call the fire department.
- C. Use only your hand to push in or turn the control knobs. Never use tools. If the knobs will not push in or turn by hand, don't try to repair them; call a qualified service technician. Force or attempted repair may result in a fire or explosion.
- D. Do not use this appliance if any part has been under water. Immediately call a qualified service technician to inspect the appliance and to replace any part of the control system and any gas control, which has been under water.

LIGHTING INSTRUCTIONS

1. STOP! Read the safety information above. Dependent on model, switch #1 may be mounted directly to valve see Fig 2A.

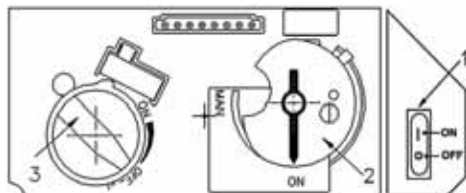

Fig 1

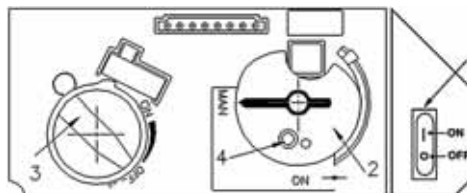

Fig 2

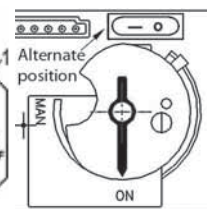
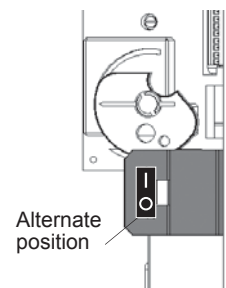



Fig 2A



2. SET ON/OFF SWITCH (1) TO "OFF" POSITION.

- Wait five (5) minutes to clear out any gas, then smell for gas, including near the floor. If you smell gas, STOP! Follow "B" in the safety information above on this label. If you don't smell gas, go to the next step.

3. AUTOMATIC IGNITION (fig. 1): Locate the pilot (fig. 3.) inside of firebox at Left Hand side.

- ON/OFF switch (1) in ON position, MAN-knob (2) in ON position; set Flame Adjustment knob (3) to lowest setting (⊖);
- On the remote control handset, press and hold the 'off' button and  (large flame) simultaneously; a short acoustic signal confirms the start has begun;
- Further short acoustic signals indicate the ignition process is in progress;
- When the pilot is lit, the Flame Adjustment knob (3) will automatically rotate to the highest setting.
- Press the  (small flame) on the remote control handset to reduce the flame height.

4. MANUAL IGNITION (fig. 2): With the window off, locate the pilot (fig. 3)

inside of firebox at Left Hand side;

- ON/OFF switch (1) in ON position, MAN-knob (2) in MAN position;
- Set Flame Adjustment knob (3) to the lowest setting (⊖);
- Push down the metallic core (4) with a pen or similar instrument; this will establish the pilot gas flow;
- Light gas at the pilot (5) with a match;
- Continue holding down metal core (4) for about 10 seconds; after release, pilot should remain lit;
- If the pilot will not stay lit after several tries, turn the gas control knob (3) to "OFF" (⊖) and call your local service technician or gas supplier.

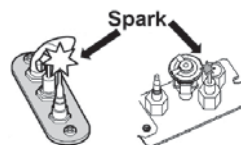



Fig 3

Reinstall the window and set the MAN-knob (2) to "ON"; turn Flame Adjustment knob (3) up (⊕) or down manually or use the up/down 'flame' buttons on the remote control handset to adjust the flame height.

TO TURN OFF GAS TO APPLIANCE

1. AUTOMATIC SHUT-OFF (using the remote control handset):

- Press and hold the  (small flame) on the remote control handset to shut-off the main burner gas flow;
- Press "OFF" button on remote handset to shut-off the appliance, including pilot flame.

2. MANUAL SHUT-OFF (using only the ON/OFF switch (1))

- Press "O" the ON/OFF switch (1) to shut-off the appliance.

Specifications

Approval & Codes

This appliance is certified to ANSI Z21.88a-2012 / CSA 2.33a-2012 American National Standard / CSA Standard for *Vented Gas Fireplace Heaters* for use in Canada and USA, and to CGA 2.17-91 *High Altitude Standard in Canada*. This appliance is for direct vent insert installations.

This appliance complies with CSA P4.1-09 *Testing method for measuring annual fireplace efficiencies*.

The installation must conform to local codes or, in the absence of local codes, with the *National Fuel Gas Code, ANSI Z223.1* or the *Natural Gas and Propane Installation Code CAN/CGA-B149*. Only qualified licensed or trained personnel should install this appliance.

This appliance must be electrically grounded in accordance with local codes, or, in the absence of local codes, with the *National Electrical Code, ANSI/NFPA 70* or the *Canadian Electrical Code, CSA C22.1*.

Ratings

Model	NG	LPG
Gas	Natural	Propane
Altitude (Ft.)*	0-4,500 feet*	
Input Maximum (Btu/h)	33,000	33,000
Input Minimum (Btu/h)	16,000	13,000
Manifold Pressure (in w.c.)	3.6	10.5
Minimum Supply Pressure (in w.c.)	5.0	11.0
Maximum Supply Pressure (in w.c.)	10.0	14.0
Main Burner Injector Marking	Front: 500 Rear: 360	Front: 280 Rear: 150
Pilot Injector Marking	51	30
Min. Rate By-Pass Screw	220	125

*High Altitude Installations

Input ratings are shown in BTU per hour and are certified without deration for elevations up to 4,500 feet (1,370 m) above sea level.

For elevations above 4,500 feet (1,370 m) in USA, installations must be in accordance with the current ANSI Z223.1 and/or local codes having jurisdiction. Heating value of gas in some areas is reduced to compensate for elevation—consult your local gas utility to confirm.

For installations at elevations above 4,500 feet (1,370 m) in Canada, please consult provincial and/or local authorities having jurisdiction.

Supply Gas

Heater engine 785ILN is used with natural gas.

Heater engine 785ILP is used with propane gas.

The supply pressure must be between the limits shown in the Ratings section above.

The supply connection is 1/2" NPT female and located on the left hand side of the control valve. The gas line entry point is on the upper left hand side on the fireplace.

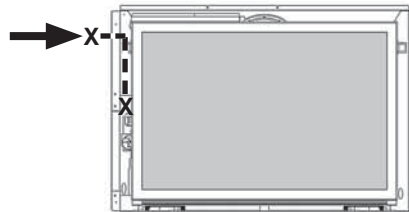

Conversion Kits

The 785 Legend G4 is supplied as natural gas or propane gas and is field convertible between fuels. See instructions packaged with the conversion kit for further information.

Electrical

The 785 does not require an electrical power source to operate as a heater. However, if the appliance is fitted with a fan, a grounded power source is required.

This appliance may ONLY be installed in an existing unaltered, functioning solid-fuel burning fireplace with a working flue and constructed of non-combustible material.

DO NOT install into combustible construction. This appliance is NOT APPROVED for installation with a zero clearance kit.

⚠ WARNING

Some materials or items, although safe, may discolor, shrink, warp, crack, peel, and so on because of the heat produced by the fireplace. Avoid placing candles, paintings, photos, and other items sensitive to heat around the fireplace.

⚠ WARNING

HOT HEARTH / FLOOR! The hearth or floor in front of the fireplace may become very hot when the fireplace heats. Do not use the hearth as a seat or shelf. Solid wood flooring in front of the fireplace (if allowed) may shrink during the heating season due to heat.

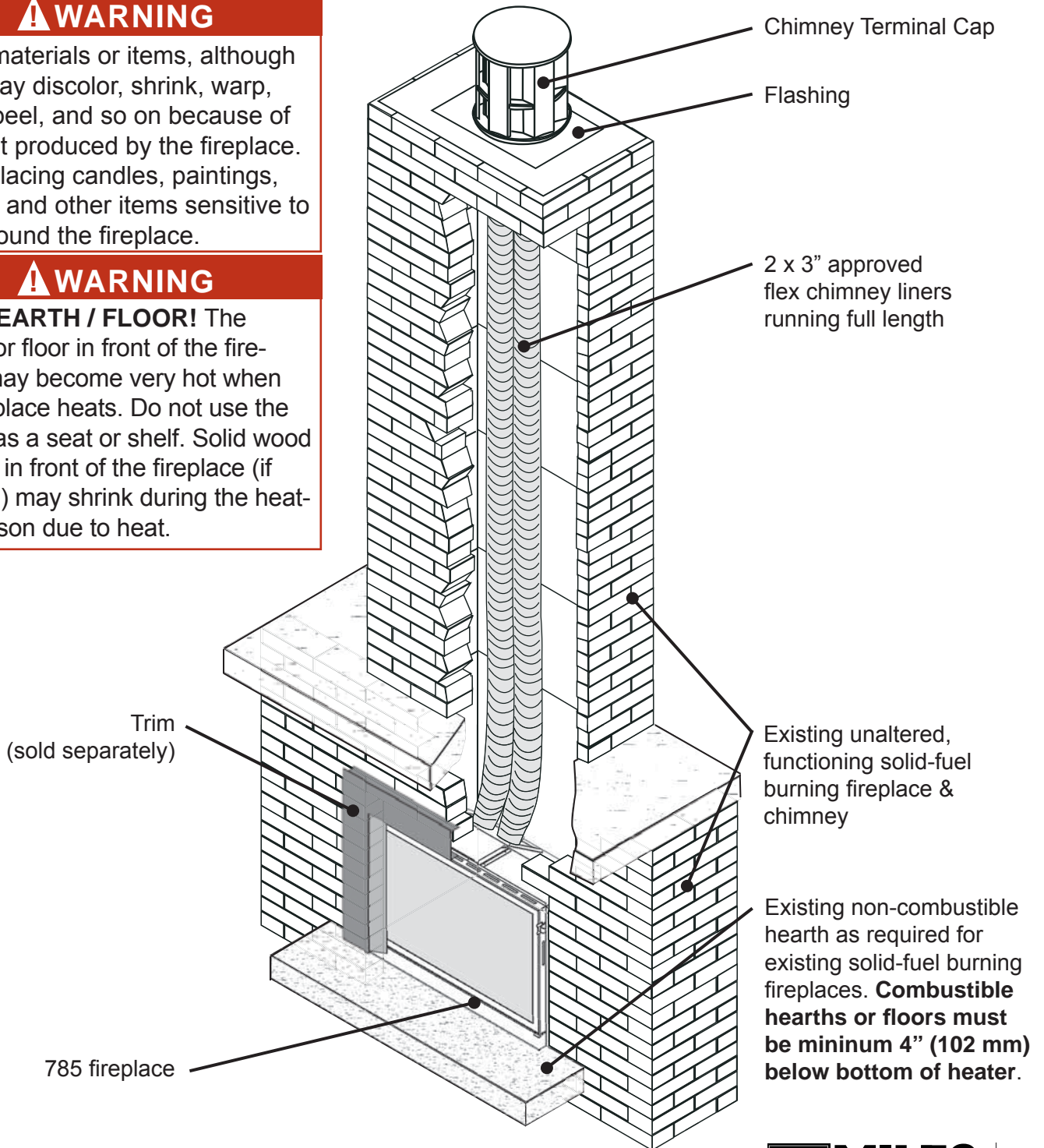

Dimensions

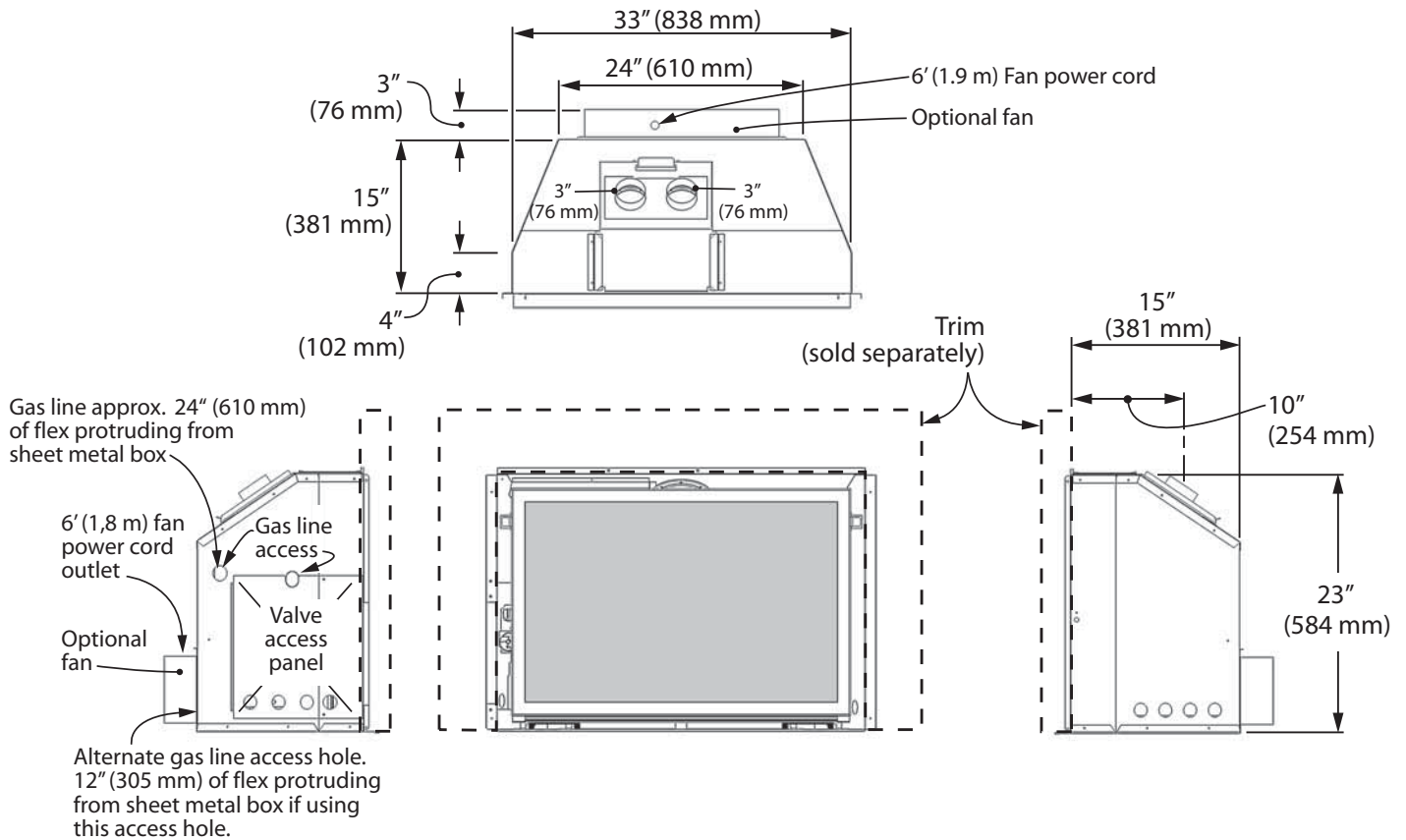

Cavity

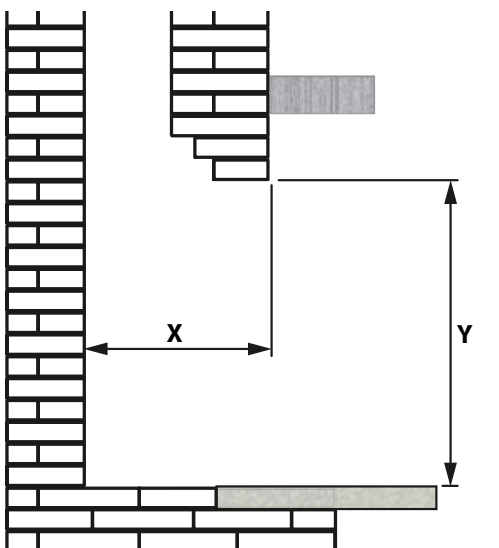

Check that masonry step does not interfere with install dimensions or vent pipe.

If mantel is combustible, see following section for allowable clearances.

A hearth that is at a height within 4" (102 mm) of the bottom of the heater **MUST be non-combustible.**

Minimum width of fireplace opening at front: 33-1/4" (855 mm)

X = 15-1/2" (394 mm) minimum
 16" (406 mm) if using leveling platform
 18-1/2" (470 mm) with fan

Y = 23-1/4" (591 mm)

⚠ WARNING

Some materials or items, although safe, may discolor, shrink, warp, crack, peel, and so on because of the heat produced by the fireplace. Avoid placing candles, paintings, photos, and other items sensitive to heat around the fireplace.

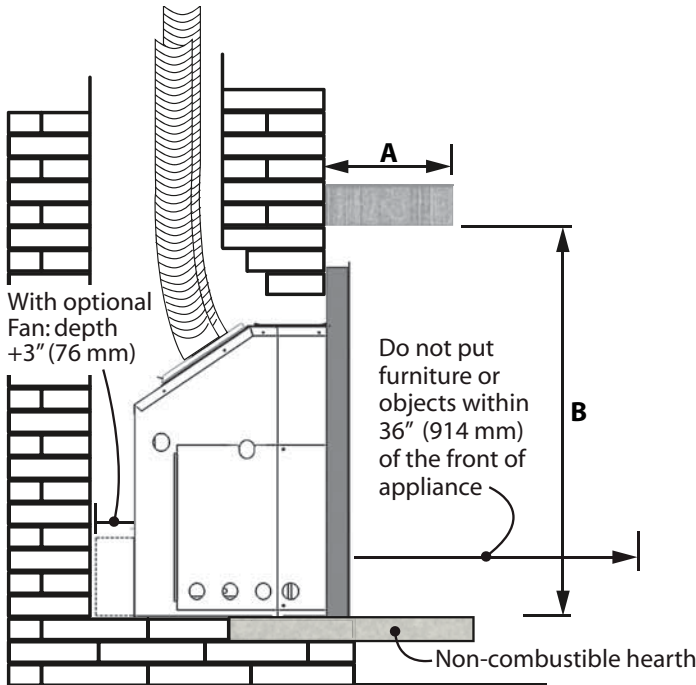

Combustible Mantel Clearances

Mantel Projection A	1" (25 mm)	4" (101 mm)	8" (203 mm)	14" (355 mm)
Mantel Height B*	34" (864 mm)	36" (914 mm)	38" (965 mm)	40" (1016 mm)

*Measure taken from the underside of the mantel to finished hearth or surface that the unit is sitting on.

Finishing Materials

Combustible materials: Material such as wood, compressed paper, plant fibers, plastics or any material capable of igniting and burning, whether flame-proofed or not, plastered or un-plastered.

Non-combustible materials: Material such as steel, iron brick, tile, concrete or materials that bear the UL mark for zero (0) fire rating.

⚠ WARNING

HOT GLASS! The use of a screen in front of the glass is highly recommended particularly in households with children.

⚠ WARNING

HOT HEARTH / FLOOR! The hearth or floor in front of the fireplace may become very hot when the fireplace heats. Do not use the hearth as a seat or shelf. Solid wood flooring in front of the fireplace (if allowed) may shrink during the heating season due to heat.

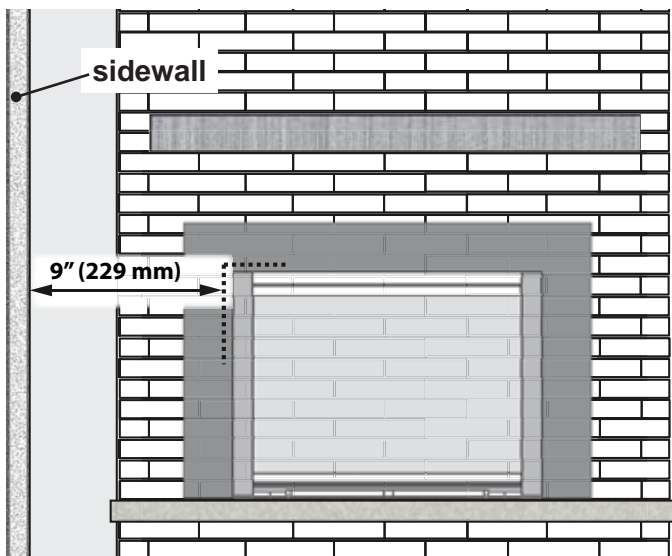

Sidewall Clearances

Minimum distance from side of appliance (liner box) to combustible wall: 9" (229 mm).

Typical Vent Installation

See list of approved venting accessories on page 36 of this manual.

NOTE: Flexible co-linear vent pipes may only be installed into existing non-combustible solid-fuel burning fireplaces and chimneys.

Vent Location

The vent terminal must be located through the roof. This direct vent appliance is designed to operate when an undisturbed airflow hits the outside vent terminal from any direction.

Check local codes for allowable vertical vent termination.

Venting Table

Maximum vertical height	40 ft (measured to bottom of termination)
Minimum vertical height	10 ft (measured to bottom of termination)
Maximum horizontal run	4 ft (measured center to center of pipe)
Maximum offset angle	45° (sweeping bend to allow for obstructions)

Venting Notes

Where possible, avoid joining flex pipes. If joints are required, use a approved connector and seal joints with *RTV high temp sealant*.

Horizontal offset is permissible to allow for routing around masonry projections. Avoid bending flex pipe over a 45 degrees radius where possible.

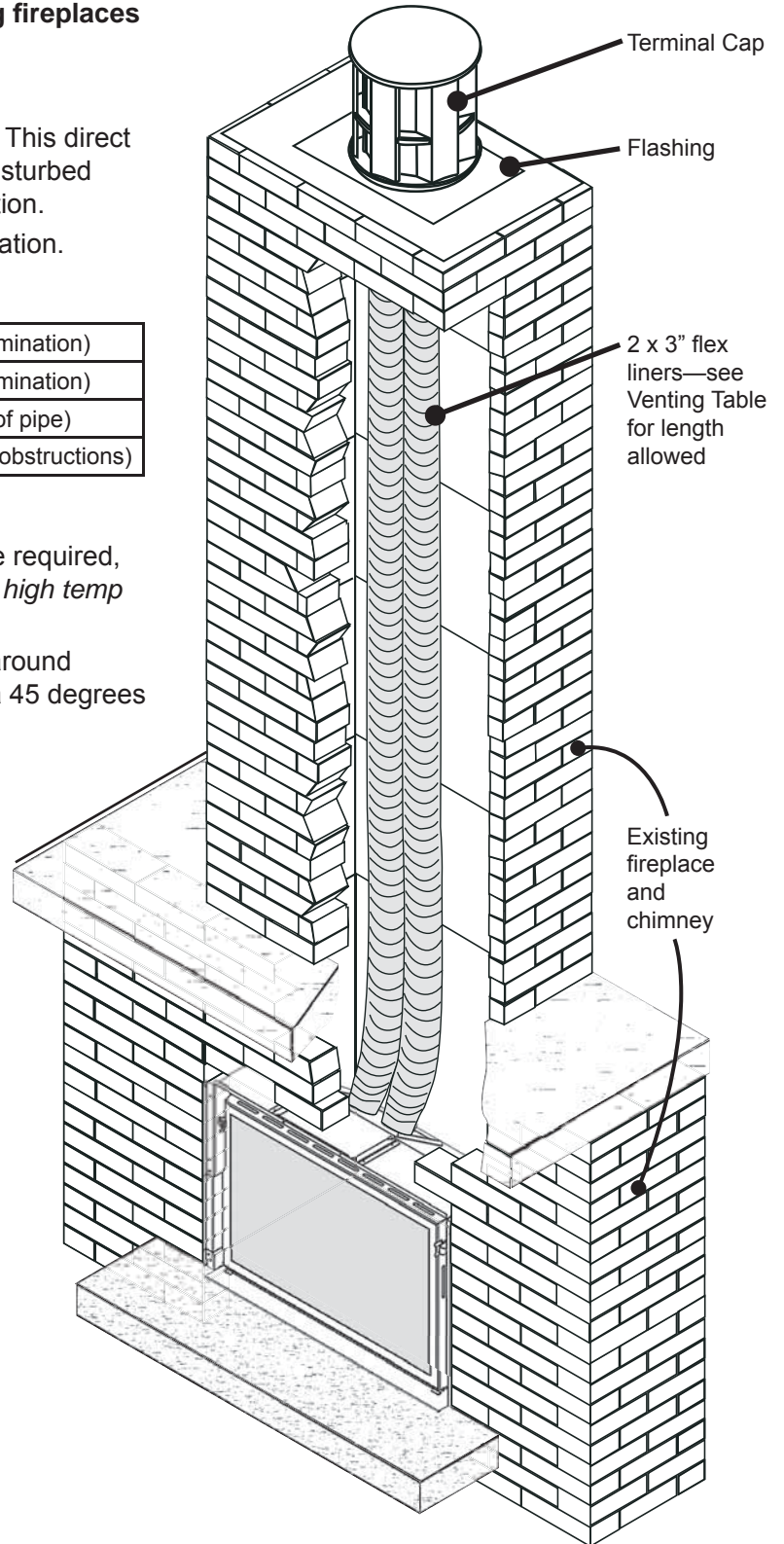
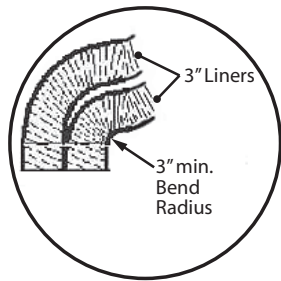

Only qualified licensed or trained personnel should install this appliance.

Installer—READ THIS FIRST

1. **YOU NEED TO KNOW FROM THE HOMEOWNER** what accessories (surround, screen, fan/blower, etc.) will be installed with this fireplace;
2. Unpack the appliance.
3. Check that you have everything.
4. Clean cavity, chimney, ash dump, and clean-out.
5. Install venting pipes.
6. Attach conversion plate to existing fireplace.
7. Remove window.
8. Install electrical wiring for fan if used.
9. Install and test fan if used.
10. Fit appliance into cavity.
11. Connect and test gas supply.
12. Install ceramic panels and fuel bed.

13. Refit window.
14. Reinstall the hot glass warning plate if it has been removed.
15. Put batteries in remote control handset and battery box. Connect battery box.
16. Set-up remote control.
17. Verify operation and adjust aeration settings.
18. Install the remote control handset wall holder.
- 19. Instruct the homeowner on the operation and maintenance of the fireplace.**
20. Install the trims and screen.

*If installing a fan, you will need to use the remote control to test the fan operation. In this case, put batteries in the handset and the battery box and set up the remote control.

Existing Fireplace Preparation

A few points must be considered before inserting the 785 into an existing fireplace cavity. Generally, no modifications are allowed to the existing fireplace that will compromise the integrity of the existing fireplace.

Components that are bolted or screwed on such as dampers or baffles may be removed to accommodate the installation of the 785 engine. **Cutting away any sheet metal parts of the existing fireplace to accommodate the installation of the 785 is prohibited.** Check with local authorities if in doubt.

Clean Fireplace and Chimney

Have the chimney swept and the fireplace cavity including ash dumps and clean-outs cleaned before installing the 785 heater and vent liners. Any creosote or soot residue remaining in the fireplace cavity chimney or clean-out may cause odors or stains once the 785 insert is installed. Consult with chimney sweep for information on how best to clean.

Existing Dampers

Factory-built, zero-clearance fireplaces will require the damper to be removed in order to install the vent liners. These dampers are usually bolted into place. Dampers in masonry fireplaces must be fixed open and may remain in place.

Ash Retaining Curbs

Some fireplaces (particularly factory-built) have a raised curb at the front edge to retain ashes. Check the dimensions carefully to ensure the 785 engine will fit behind any raised curb (some curbs may be removed separately from the refractory base).

Existing Fireplace Preparation

Gas Line Routing

Plan the routing of the gas line before proceeding. Utilize the existing hole for the gas line of the factory-built fireplace.

If the fireplace has no access hole, carefully drill an access hole of 1.5 inch (38 mm) or less through the lower sides or bottom of the firebox. The access hole must be plugged with non-combustible insulation after the gas supply line has been installed.

See *Dimensions* section for detailed location of gas inlet. Also, take into consideration whether or not a fan or shut-off valve will interfere when planning routing of the gas line.

Existing Glass Doors and Wire Screens

Existing glass doors must be permanently removed prior to installing the 785 insert.

Combustible Mantels

Combustible mantel clearances must conform to those required for the original solid-fuel fireplace into which the 785 is being installed.

Attach Warning Conversion Plate to Existing Fireplace (plate supplied loose with 785 heater)

Attach the “This fireplace has been converted...” label to the existing fireplace using screws or other mechanical means and store any removed parts in back of the existing fireplace for future use.

Appliance Preparation

Unpacking the appliance

Beware of sharp edges! Wear gloves!

1. Unpack the appliance.
2. Unpack any loose items from around the appliance and check against the Pack Content list provided in the documentation package.
3. Remove the window and set aside in a safe place to avoid damage—see next page.
4. **Verify that you have all the components required for the installation, including:**
 - *ceramic panels and logs;*
 - *trim;*
 - *venting components and accessories;*
 - *fan and electrical components for its installation if used.*

Appliance Preparation

Window Removal

The window is held in place by a spring-loaded lever on each side.

1. To remove the window, locate the levers on each side of the window towards the top. Using your finger, pull the lever towards you and unhook it from the window frame bracket.
2. Gently pull the top of the window outward.
3. Lift the window out of its bottom railing and set it aside in a safe place to avoid damage.

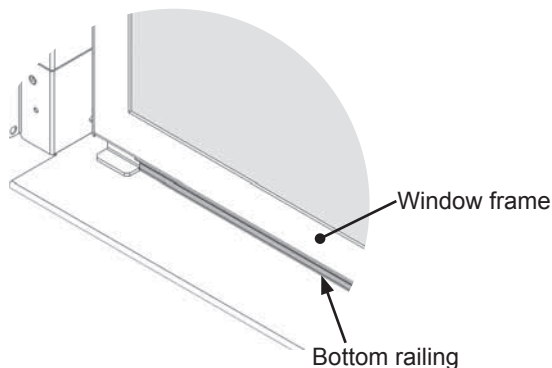

Section Views

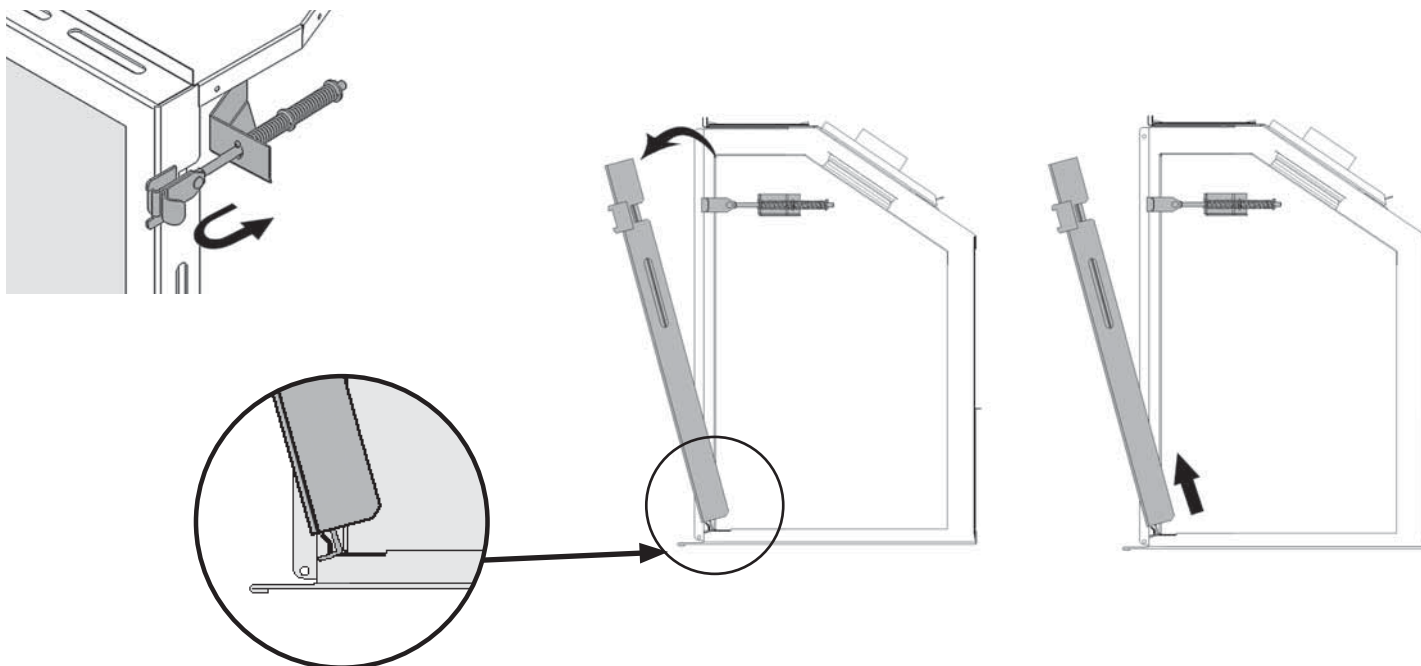

Fan installation

If the 795CFK Circulating Fan Kit (blower) is to be installed, we suggest that you do it now.

The fan cavity is accessible from the back of the firebox to facilitate its installation. If the fan is retrofitted after the installation of the appliance, the appliance will need to be removed. Therefore, we recommend that, where possible, the fan be installed before the appliance is fitted into the cavity.

Refer to instructions provided with the 795CFK to install the fan.

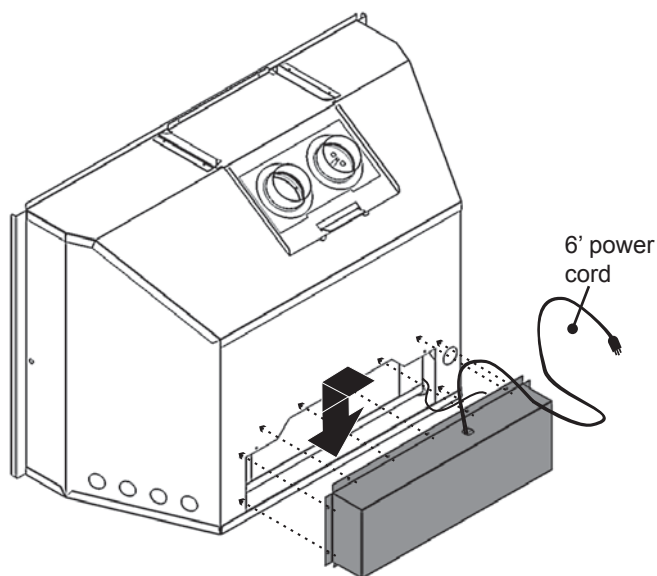

Appliance Preparation

Venting Installation

IMPORTANT: This appliance's venting system is room sealed and therefore, does not require room air to be used in the combustion process.

1. Rough-in two 3" diameter vent liners into the existing chimney system from the roof. Be careful not to tear or damage the liners in the process. It may be easier to install both liners at the same time rather than one at a time. Leave plenty of liners at the bottom to facilitate the connection of the liners to the vent slider. **It is best to leave the top termination until later.**

Designate and mark the top and bottom of one liner as "EXHAUST" to avoid confusion later.

2. a) **Large cavity opening**

Slide the appliance into the cavity.

- b) **Smaller cavity opening**

Release the two screws retaining the vent slider to the front of the firebox.

Remove the slider from the firebox by sliding it towards the back of the firebox.

3. Apply RTV sealant to the collars on the vent slider and fit the two liners **ensuring that the exhaust liner is connected to the identified "EXHAUST" vent collar.** Secure with 4 tapping screws per liner.

If the vent slider was removed from the firebox, slide the firebox onto the vent slider in the cavity taking care not to damage the liners. **Make sure that the rear edge of the slider is hooked over the cleat on the firebox.** Secure the vent slider to the front of the firebox with two screws removed earlier.

4. From the roof, pull the liners and fit the flashing.

5. Fit the terminal cap **ensuring that the exhaust liner is connected to the exhaust vent collar.** Secure with screws.

6. Seal the terminal and flashing from water penetration as required.

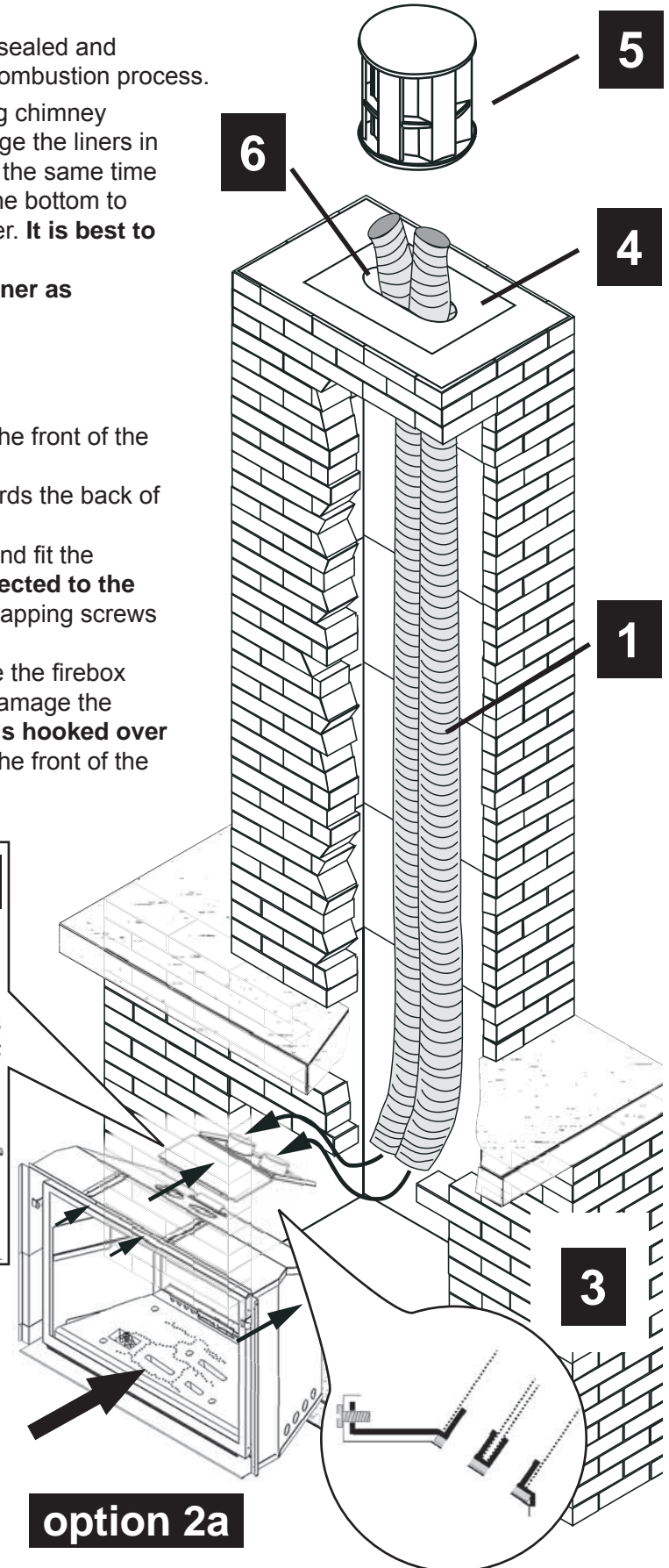
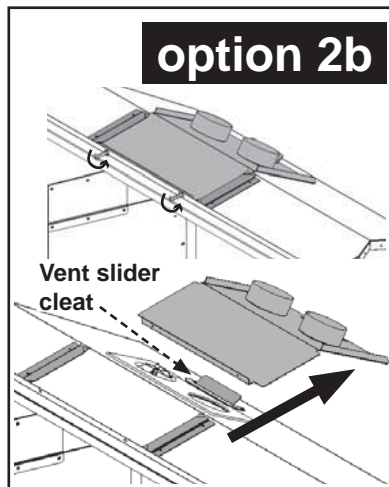

option 2a

⚠ WARNING
Failure to position the parts in accordance with these diagrams or failure to use only parts specifically approved with this appliance may result in property damage or personal injury.

Supply Gas Installation

The gas supply inlet connection is a 1/2" NPT female. Gas shut-off valve supplied on the end of stainless steel flexible connector. Flex connector is located on the left hand rear corner of the appliance.

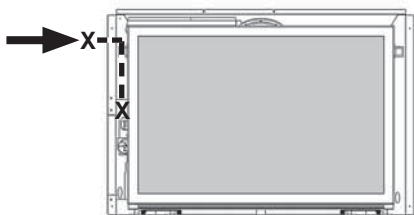

Use only new black iron or steel pipes or copper tubing if acceptable—check local codes. Note that in USA, copper tubing must be internally tinned for protection against sulfur compounds.

The burner module and gas train on this appliance may be removed as a unit for servicing. The flex pipe supplied with the unit provides a union for removal of the module.

Unions in gas lines should be of ground joint type.

The gas supply line must be sized and installed to provide a supply of gas sufficient to meet the maximum demand of the appliance without undue loss of pressure.

Sealant used must be resistant to the action of all gas constituents including LP gas. Sealant should be applied lightly to male threads to ensure excess sealant does not enter gas lines.

Pressure test the supply line for leaks.

The appliance and its individual shut-off valve must be disconnected from the gas supply piping system during any pressure testing of that system at test pressures in excess of 1/2 psig (3.5 kPa).

The appliance must be isolated from the gas supply piping system by closing its equipment shut-off valve during any pressure testing of the gas supply piping system at test pressures equal to or less than 1/2 psi (3.5 kPa).

Failure to either disconnect or isolate the appliance during pressure testing may result in regulator or valve damage and void the warranty. Consult your dealer in case of damage.

Pressure Test Points

The minimum supply pressure is given in the section *Specifications* of this manual—page 16.

All piping and connections must be tested for leaks after installation or servicing. All leaks must be corrected immediately.

When testing for leaks:

- Make sure that the appliance is turned off.
- Open the manual shut-off valve.
- Test for leaks by applying a liquid detergent or soap solution to all joints. Bubbles forming indicate a gas leak.

**Never use an open flame to check for leaks.
Correct any leak detected immediately.**

The pressure test tapping locations is shown in the figure below. An internal regulator within the valve controls the burner manifold pressure.

The correct pressure range is shown in the table in section *Specifications* of this manual on page 16. The pressure check should be made with the burner light and at its highest setting. See *Lighting Instructions* section for full operating details on page 15.

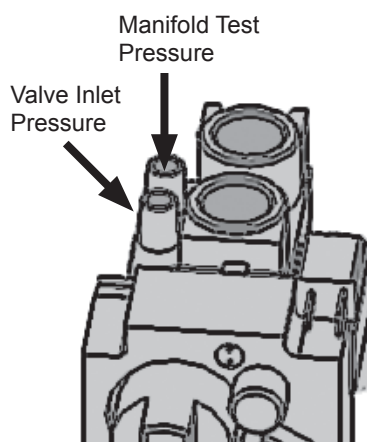

Pressure Testing

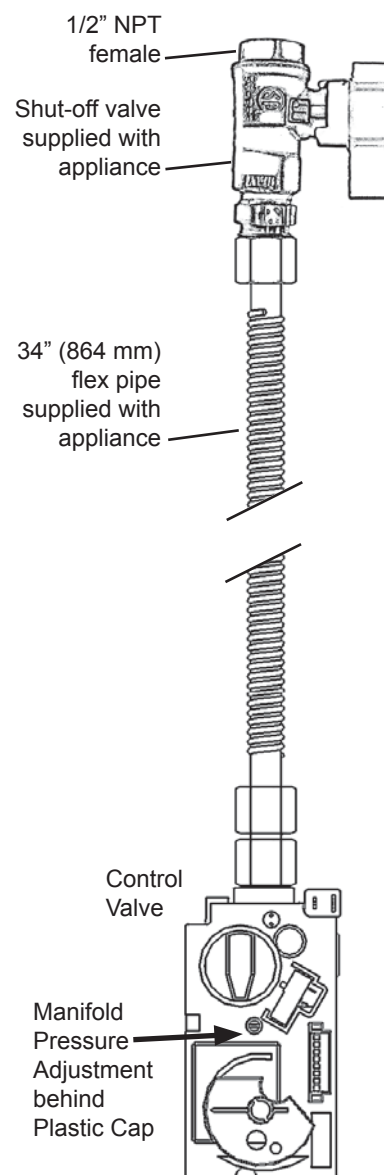

Valve Assembly

Supply Gas Installation

Alternate Inlet Connection

In cases where local codes do not permit the flex connector to be used inside the appliance case, reconnect the flex connector outside of the appliance case. A cut-out is provided in the appliance case for this purpose.

Use common elbow and fittings (not supplied) to redirect the position of the flex connector. **NOTE:** the flex connector bend radius must be no smaller than the size of a golf ball (approx. 1-3/4" or 44 mm).

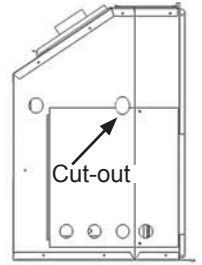

1. Remove flex connector.

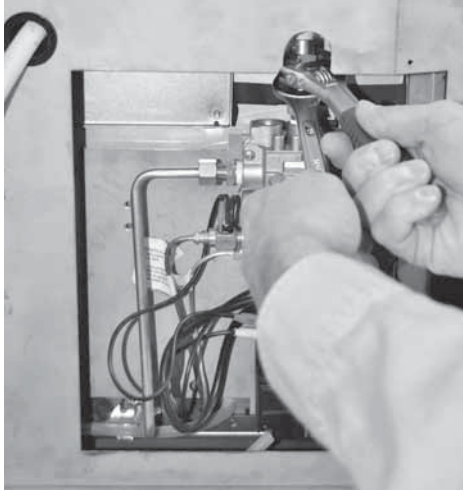

2. Remove flared connector.



3. Install new inlet elbow.

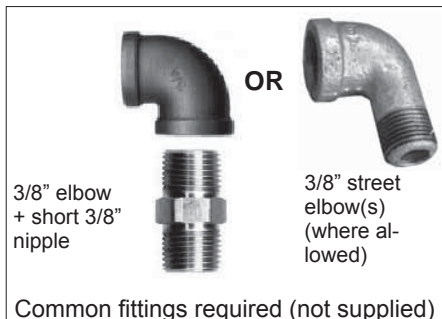
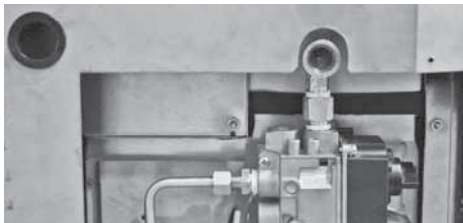

Option 1

4. Add flared connector to new elbow and fit flex connector. Close the access panel.

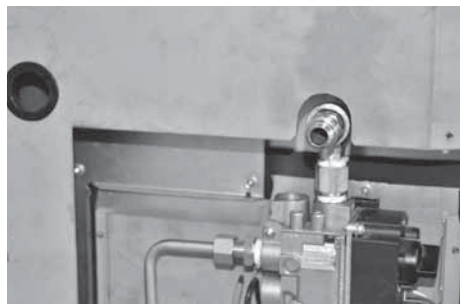

Flex connector redirected using one elbow.



Top view, left side



Front view, left side

Option 2

4. Add another elbow, the flared connector and refit the flex connector. Direct it towards the rear of the appliance or downward. Close the access panel.

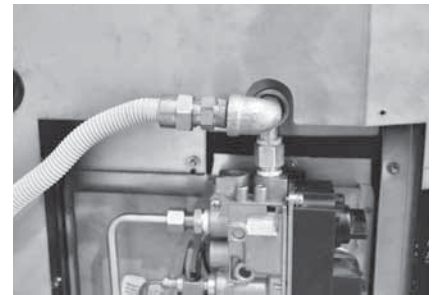

Flex connector redirected using two elbows.

Burner Removal and Reinstall

The ceramic panels can be installed without removing the burner. However, you can remove the burner for additional space if desired.

1. Remove the 2 screws fixing the rear of the burner to the manifold bracket as indicated. Do not remove the air shutter screws.

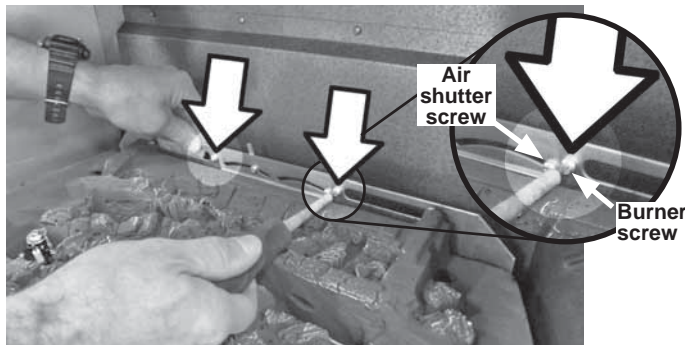

2. Grab the burner as indicated and gently pull up the rear first and then the front. **Be careful not to hook the pilot hood as you pull the burner up.**

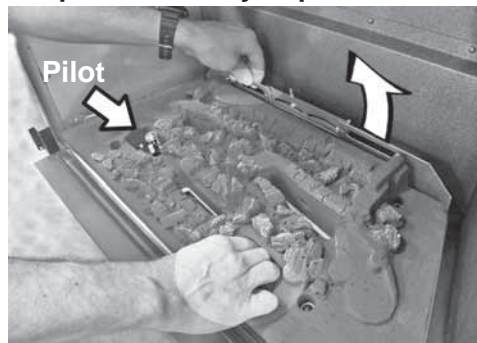

3. To reinstall the burner, fit the burner in the firebox inserting the front first. **Again, be careful not to hook the pilot hood when fitting the burner over the pilot.** Fix the burner to the manifold bracket at the rear with 2 screws.

Ceramic Panels Installation

The following guidelines apply for all panels. You do not need to remove the burner to install the panels.

1. Inside the firebox, on the top of each side, release the screw of the side panel anchors (one per side) just enough to allow them to rotate.



2. Place the rear panel against the back of the firebox, on the ledge at bottom, behind the burner.

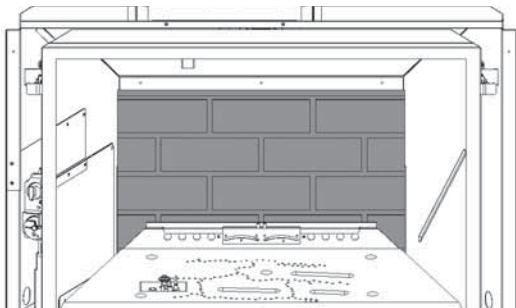

3. Rotate the anchor up and out of the way and slide the left hand side panel against the firebox side. Rotate the anchor back down to hold the panel.
4. Rotate the anchor up and out of the way and slide the right hand side panel against the firebox side. Rotate the anchor back down to hold the panel.

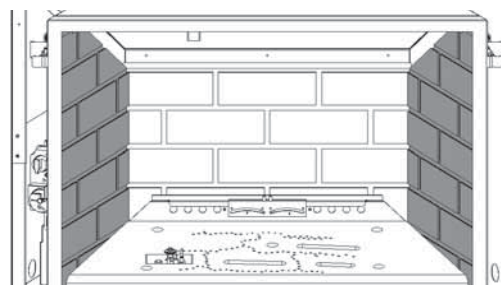

5. Tighten the side panel anchors on each side of the firebox.



6. Install the top panel supporting it with the back and side panels.

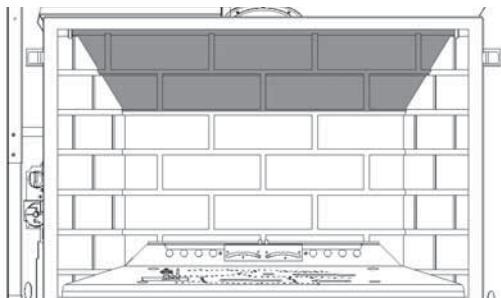

7. Discard the front bricks as they are not required on this fireplace.

Ceramic Logs Installation

Unpack the ceramic logs very carefully to avoid damaging them. Install the logs as shown below. Please note that **the position of the logs is critical to insure proper performance of the appliance.**

When placing the base and middle logs, rotate them a little bit to anchor them into position.

1. Place the rear log on the back of the ember bed locating its right-hand end over the key in the ember bed. Slide the log back until it rests against the vertical sheet metal edge.

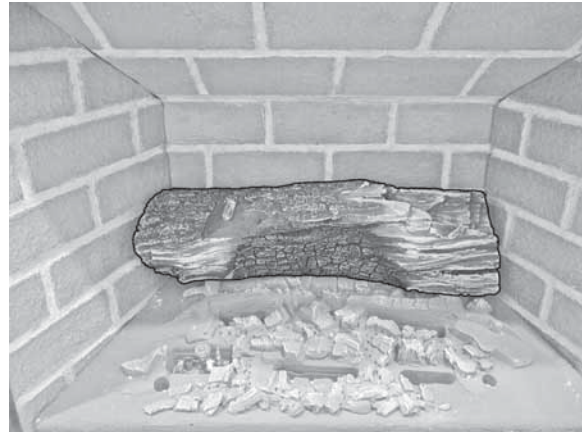
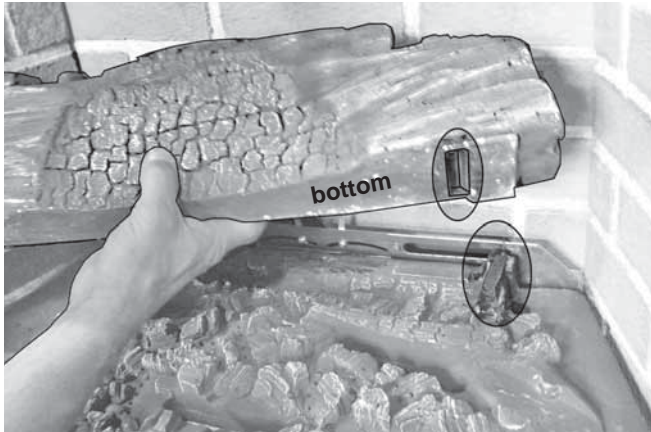

2. Place the left-hand middle log in front of the rear log locating it over the key in the ember bed as indicated. The flat part of the log sits on the platform. The key notch is at the back of the log.

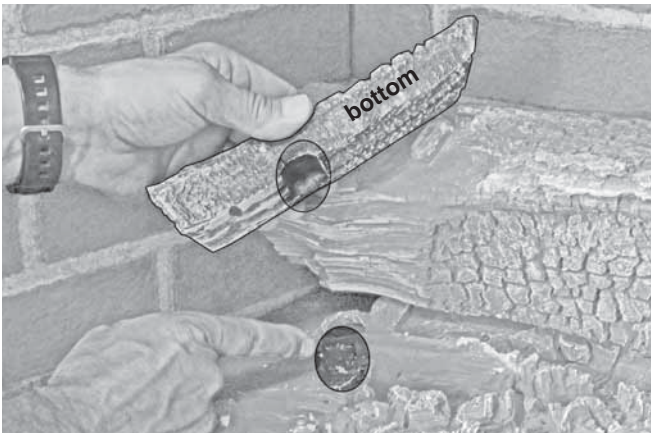

3. Place the left-hand base log on the platform locating it on the key as indicated. Move the log slightly forward so that it does not cover the pilot. However, do not cover the two burner holes at the front of the log.

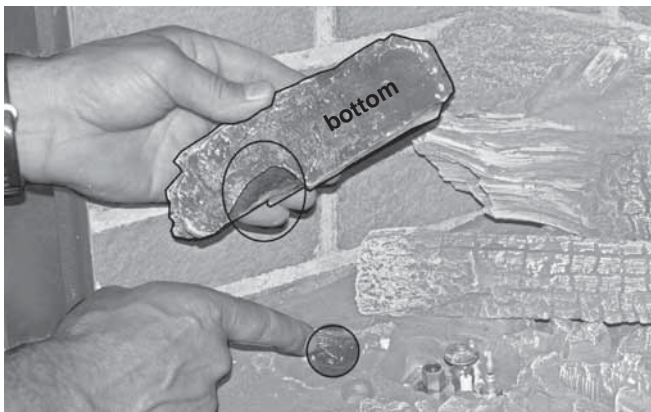

Ceramic Logs Installation

4. Place the center base log locating its notch on the key in the ember bed as indicated. The darkened part of this log should be on the left side.

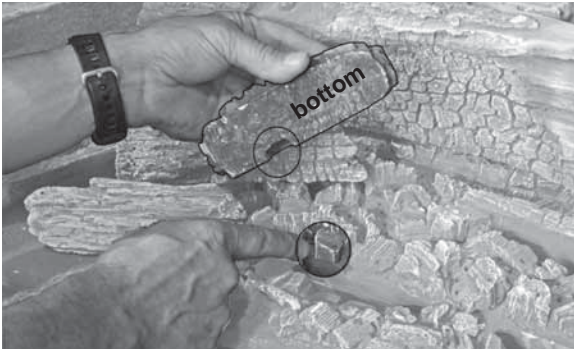

5. Place the right-hand base log locating its notch on the key in the ember bed as indicated.

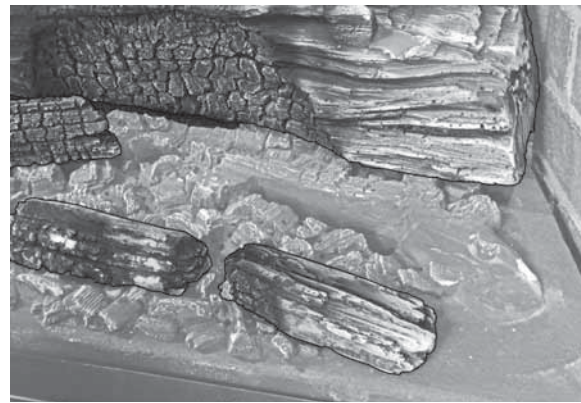
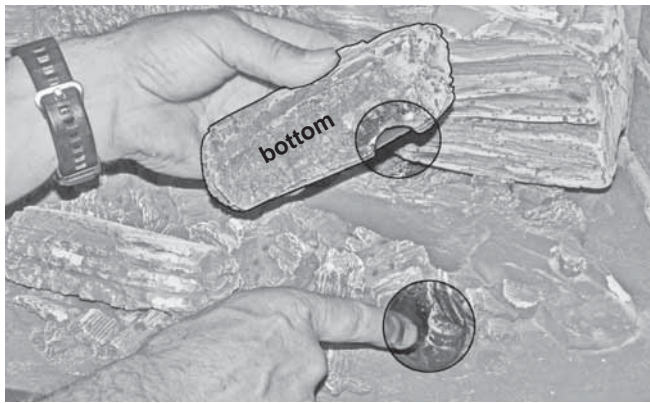

6. Place the right-hand middle log locating its notch on the key in the ember bed as indicated.

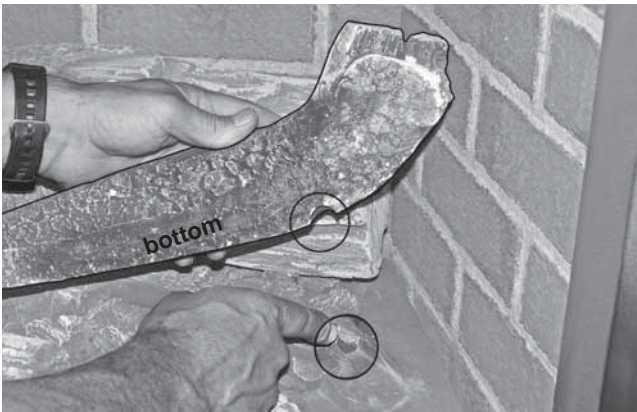

7. Place the left-hand cross log locating its notch on the key on the top of the rear log as indicated. Rest the front end of the log on top of the left base log as indicated.



Ceramic Logs Installation

8. Place the right-hand cross log locating its notch on the key on the top of the rear log as indicated. Rest the front end of the log centered on top of the center base log.

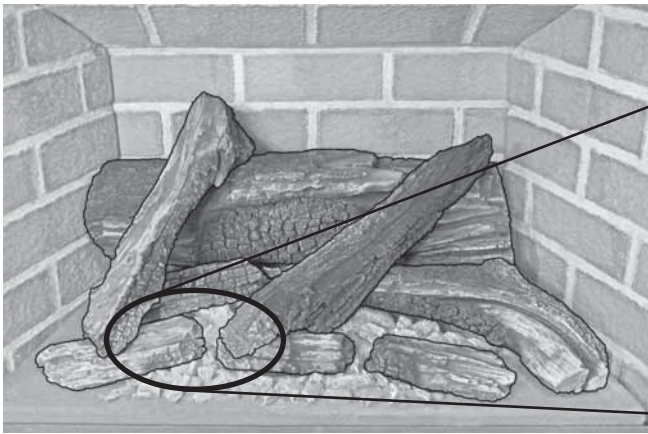

Ensure the logs do not cover the burner holes indicated here

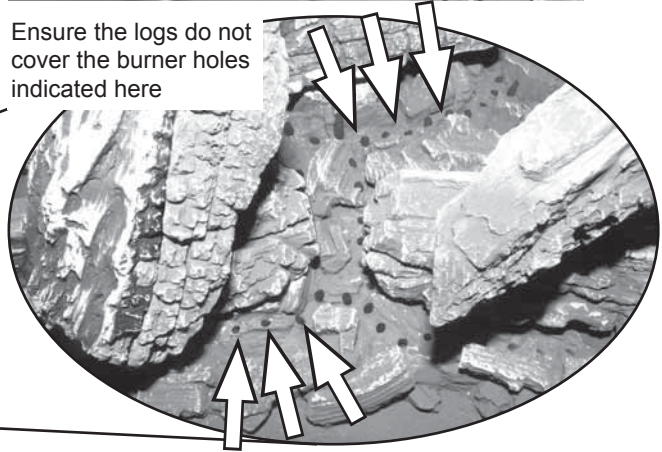

Window Refitting

1. To refit the window, place it in its bottom railing and rotate its top against the firebox.
2. While you hold it, pull the side levers back into the window brackets on each side.

IMPORTANT: To ensure a safe operation, verify that the levers are hooked properly to the window tabs; then, pull out the top of the window and release it to insure the springs return it.

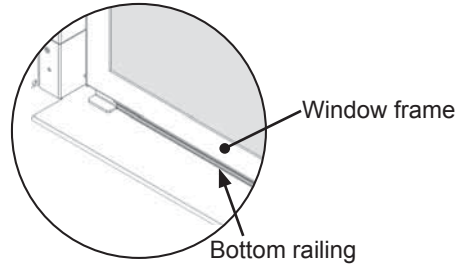

3. Apply light hand pressure against the window frame sides to bed-in the window seal.

4. If the Hot Glass Warning plate has been removed from the front lower corner of the window, reinstall it by sliding it between the glass and the frame as indicated below.

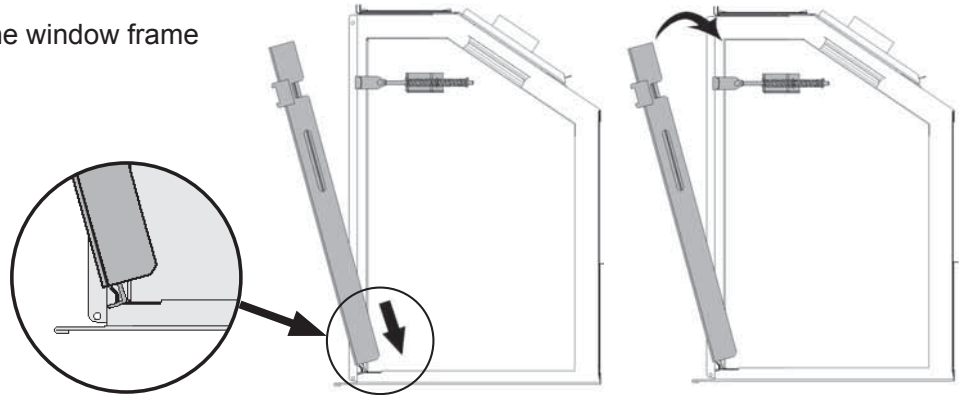

! WARNING: EXTREMELY HOT GLASS AND FIREPLACE
Risk of severe burns. Keep children away from fireplace & controls.
AVERTISSEMENT : VITRE ET FOYER EXTREMEMENT CHAUDS
Risque de graves brûlures. Gardez les enfants loin du foyer et des commandes.

Hot Glass Plate

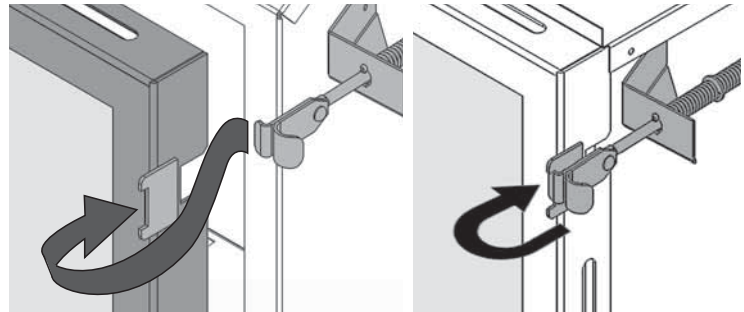
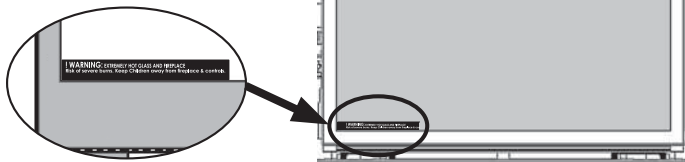

Remote Control Initial Set-up

The receiver and the handset of the remote control system must be initially synchronized before the first use.

1. Remove the cover of the battery box (1 screw).



2. Insert alkaline batteries in the battery box and handset.
3. Refit the cover and secure with the screw.
4. On the left hand side of the firebox, pull the loose wire that is already connected to the receiver and connect it to the battery box. Place the battery box upside on the left of the firebox.

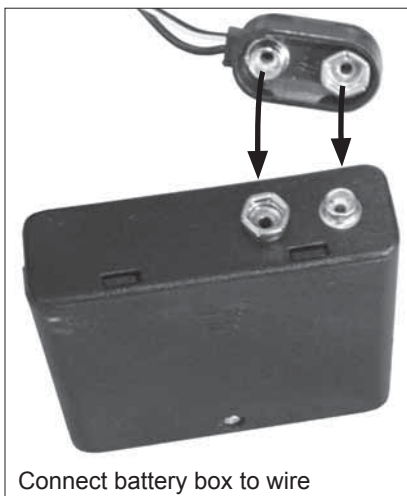

5. With a sharp object, press and hold the receiver's reset button until you hear one short and one long beeps. Release the reset button after the second beep.

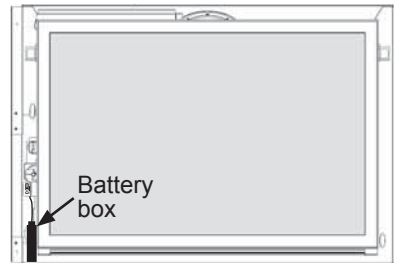

Battery box connection

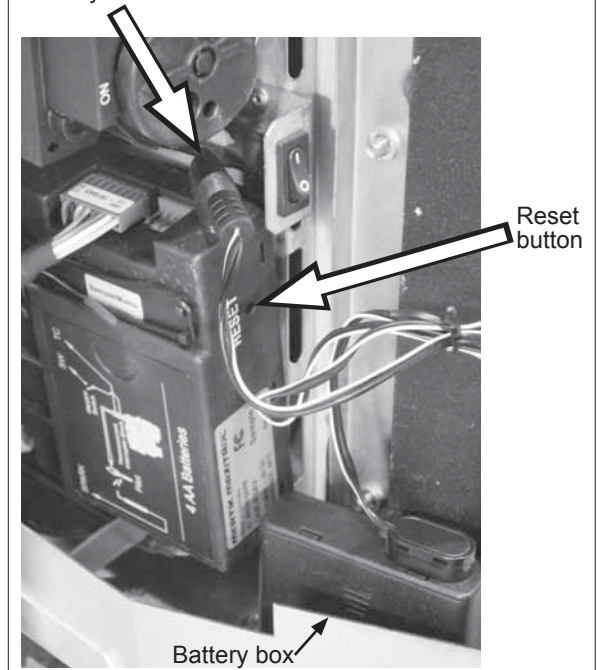

6. Within the subsequent 20 seconds, press the (small flame button ()) on the remote handset until you hear two short beeps confirming the synchronization is set.

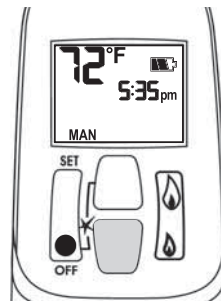

This is a one time setting only and is not required when changing the batteries in the remote receiver. The remote control system is now ready to use.

Operation Check & Aeration Settings Adjustment

Operation Check

Turn the fireplace flame up and down using the remote control to confirm that the full range of inputs is achieved—see the remote control operation instructions on pages 9–14.

Aeration Settings

Light the fire and allow the unit to warm up for 10–15 minutes to evaluate the flame picture. Burners are equipped with an adjustable shutter to control primary aeration. See the figures below. The shutters are factory-set to an aeration gap which will give optimum performance for the vast majority of installations.

In a few unusual installations, the flame picture may be improved by adjusting the aeration. The need for adjustment should be determined only by operating the appliance with the ceramic logs and window installed.

Increasing aeration (open) will cause the flames to appear more transparent and blue showing more ceramic effects glow.

Decreasing aeration (close) will cause the flames to appear more yellow or orange showing less ceramic effects glow.

Too little aeration may result in black carbon forming and dropping into the firebox.

Note: The image below shows how the restrictors work. Their positions are for illustration purposes only and **DO NOT** represent how you should set them.

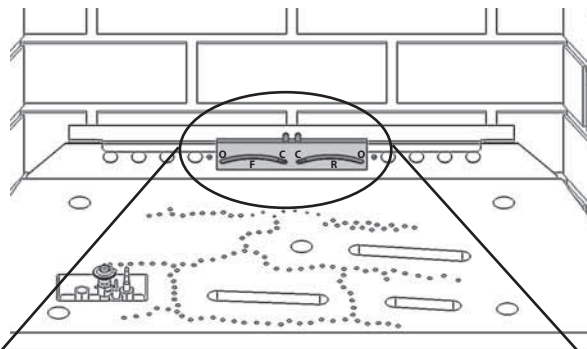

O=Open F=Front burner
C=Closed R=Rear burner

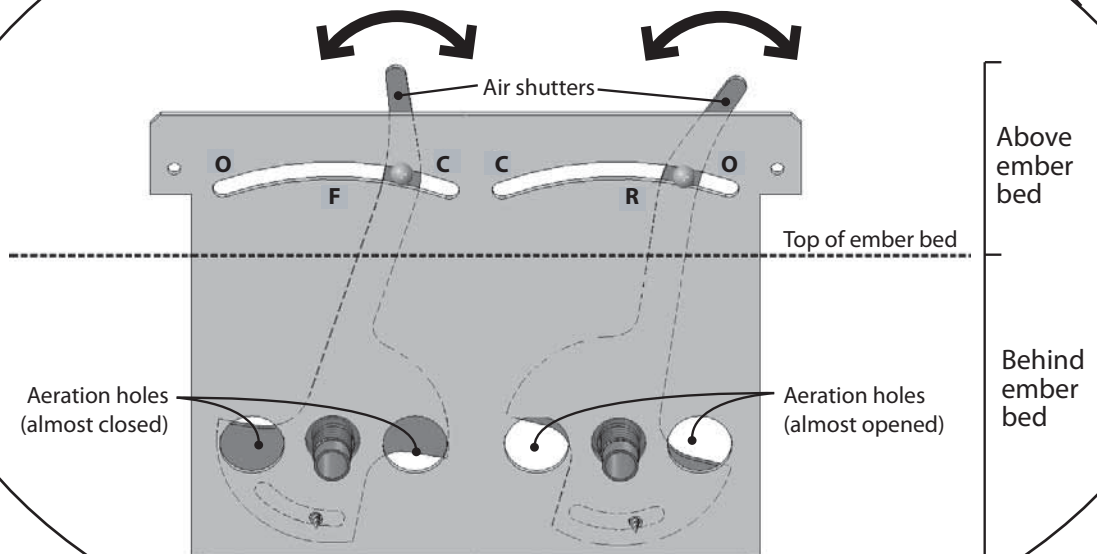

Side Shrouds Installation

The side shrouds are required to install the front on the appliance. They are supplied with the engine. Fit them to the appliance outer case as indicated (2 screws/side).

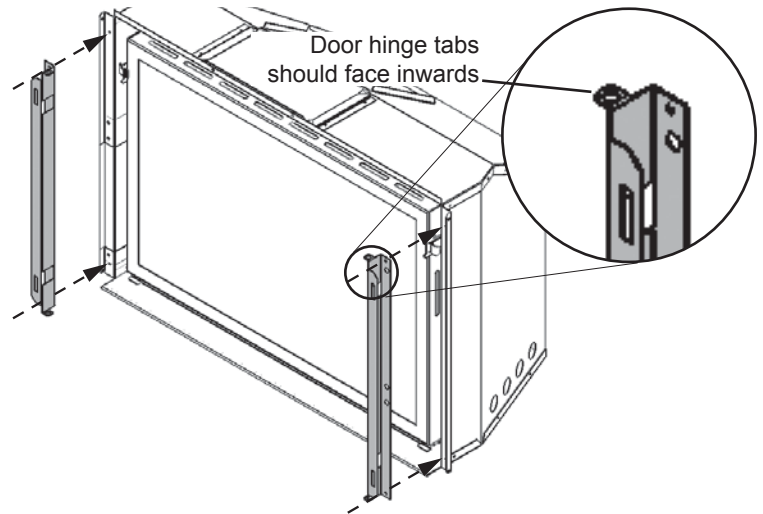

Front, Trim and Barrier Screen Installation

Install the front or trim chosen by the customer for their fireplace. Install as well the barrier screen which is provided with the front or trim.

Show the customer how to access the controls when the front or trim are installed and how to remove them.

Follow the instructions provided with the front or trim and leave those instructions behind for the customer's further reference.

Remote Control Handset Wall Holder Installation

The remote control kit for this fireplace comes complete with a wall-mounted holder. This holder is not required in all installations but is provided as an optional feature for those customers who wish to mount the remote handset to the wall.

To install the holder to the wall, find a convenient location and use the hardware provided with the kit. See the diagram below for required hardware and configurations. Note that the holder can be installed at the base of a light switch plate.

IMPORTANT. The location of the remote control handset is important to assure proper temperature regulation. To obtain a constant temperature, we recommend that the handset should be between 3 and 15 feet away from the appliance **but not directly above it**. We also advise that the handset should be located away from any other heat source and not in direct sunlight as this may affect the temperature sensor located in the remote handset.

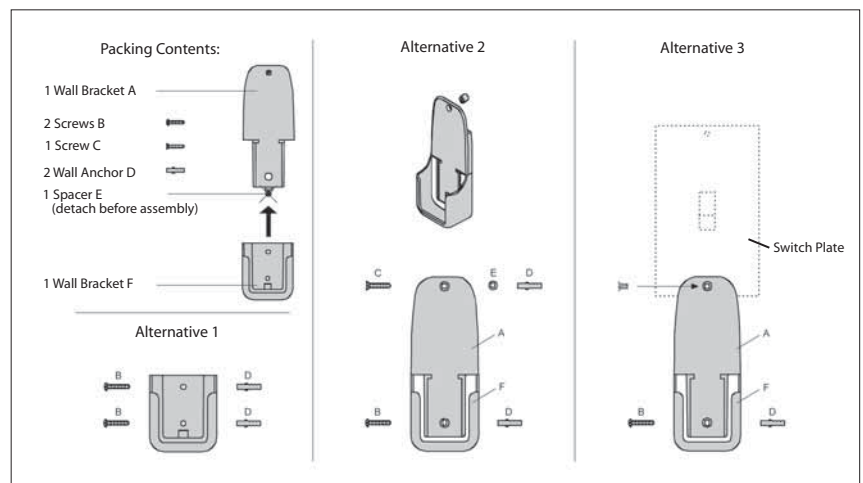

Wiring Diagram

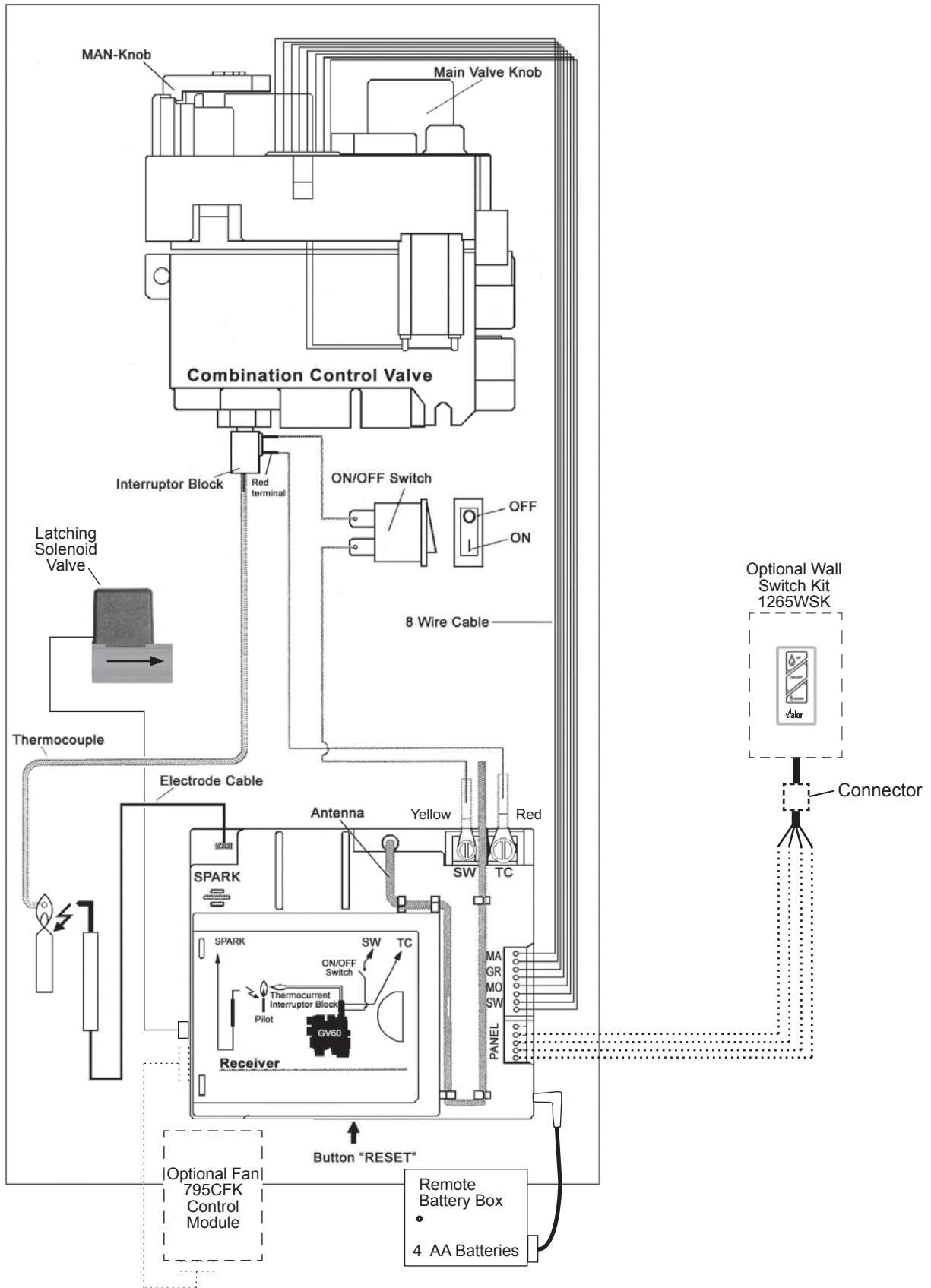

GV60 Wiring Diagram

Approved Venting Components

Approved Direct Vent Suppliers for Valor Models 700, 739, 780, 785 and RF24DV									
		Venting Parts Code / availability by Manufacturer							
		DURA-VENT	SELKIRK	ICC EXCEL DIRECT	SECURE VENT	RLH INDUSTRIES	AMERIVENT	MILES INDUSTRIES	
Venting Parts Description									
Termination Caps	Vertical	Standard Co-axial	46DVA-VC	4DT-VC	TM-4VT	—	HSDV4658-1313	4DVC 4DH-1313	—
		High Wind Co-axial	46DVA-VCH	—	—	SV4CGV	—	—	—
		Extended Co-axial	46DVA-VCE	—	—	—	—	—	—
		Co-linear	—	—	—	3PDVCV	HS-C33U-99 HS-C33F-1313	HCL-99-33 HCL-913-33 HCL-1313-33	559CLT
Vent Adapters / Couplers	Universal Adapter 3" Flex Coupler	2150	—	TM-CFAA3	—	—	—	—	
	Co-linear Flex Connector	46DVA-ADF	—	—	—	—	—	—	
	Co-axial-to-Co-linear Adapter	46DVA-GCL	—	TM-4CAA	—	—	4DCAB33	556CLA	
	Co-linear-to-Co-axial Adapter	46DVA-GK	—	TM-4CTA	—	—	4DCAT33	—	
Aluminum Flexible Liner	3" diameter	NOTE: 2-ply liner approved to CAN/ULC S635 suitable for venting gas appliances. As manufactured by Z-Flex, Flexmaster or others.							
		2280 Series	3" ACFL	—	—	—	—	3AFL-35	—
Flashings	Roof Flashing 0/12-6/12	46DVA-F6	4DT-AF6	TF-4FA	SV4FA	—	—	4DF (0/12-5/12)	—
	Roof Flashing 7/12-12/12	46DVA-F12	4DT-AF12	TF-4FB	SV4B	—	—	4DF12 (6/12-12/12)	—
	Flat Roof Flashing	46DVA-FF	—	TF-4F	SV4F	—	—	—	559FSK
	Masonry Flashing	—	—	TF-4MF	—	—	—	—	—

- Notes:**
- 1) Follow instructions supplied with each manufacturer's components.
 - 2) Termination caps manufactured by RLH Industries or American Metal Products are from Homestyle Chimney Collection and can be ordered in one of the following finishes: a) aluminum; b) black powder coated; c) solid copper.

Warranty

If you have a problem with this unit, please contact your dealer or supplier immediately. Under no circumstances should you attempt to service the unit in any way by yourself. The warranties in paragraphs 1 and 2 are provided only to the first purchaser/user of this unit, are not transferable and are subject to the conditions and limitations in paragraphs 3, 4 and 5. Please review the conditions and limitations carefully and strictly follow their requirements.



1. Extended Warranty Coverage

For a period of up to ten (10) years, Miles Industries Ltd., (the “Company”) or its appointed distributor will at its option pay the initial purchaser for the repair of, or will exchange the following parts or components which are found to be defective in material or workmanship under normal conditions of use and service:

Part or Component	Defect Covered	Maximum Warranty Period
Exterior steel casing	Corrosion	10 years
Glass	Loss of structural integrity	10 years
Cast iron parts	Corrosion	10 years
Firebox and heat exchanger	Corrosion (but not discoloration) causing loss of structural integrity	10 years

2. Two-Year Parts Warranty

In addition, for two (2) years from the date of purchase, the Company, at its option, can repair or exchange all parts and components not listed above but that are found to have a *bona fide* defect in material or workmanship under normal conditions of use.

3. Conditions and Limitations

- a) The warranty registration card must be completed by the initial owner and returned to the Company within 90 days of purchase.
- b) Installation and maintenance must be performed by an authorized and trained dealer in accordance with the Company’s installation instructions.
- c) This warranty is void where installation of the unit does not conform to all applicable codes including national and local gas appliance installation codes and building and fire codes.
- d) The owner must comply with all operating instructions.
- e) The Company is not responsible for the labor costs to remove defective parts or re-install repaired or replacement parts.
- f) The first purchaser or user of the unit will be responsible for any shipping charges for replacement parts as well as travel time incurred by the dealer to perform the warranty work.
- g) This warranty applies to non-commercial use and service and is void if it is apparent that there is abuse, misuse, alteration, improper installation, accident or lack of maintenance to the unit.
- h) This warranty does not cover damage to the unit through:
 - i) Improper installation, operational or environmental conditions.
 - ii) Inadequate ventilation in the area or competition for air from other household equipment or appliances.
 - iii) Damage due to chemicals, dampness, condensation, or sulphur in the fuel supply lines which exceeds industry standards.
- i) This warranty does not cover glass, log breakage or damage to the unit while in transit.
- j) The Company does not allow anyone to extend, alter or modify this warranty and assumes no responsibility for direct, indirect or consequential damages caused by the unit. State or provincial laws where the first purchaser or user resides may provide specific rights to extend this warranty and, if so, the Company’s sole obligation under this warranty is to provide labor and/or materials in accordance with those laws.

4. Discharge of Liability

After two (2) years from the date of purchase, the Company may, at its option, fully discharge all obligations under this warranty by paying to the first purchaser/user the wholesale price of any defective parts.

5. No Other Warranty

All obligations to repair this unit are defined in this warranty. Some states or provinces may specifically mandate additional warranties on the part of manufacturers, but in the absence of such specific legislation, there is no other warranty or obligation expressed or implied.

Spare Parts

Code	Description	Part Number
1	Exhaust Slide Assembly	4002287
2	Exhaust Slide Gasket	4000176
3	Restrictor enclosure	4002330
4	Metal strip	4002329
5	Restrictor assembly	4002707
6	Coil spring	4002605
7	Rod support	4002331
8	Valve access cover	4002289
9	Side brick anchors (2)	4001283
10	LH Explosion relief assembly	4001286
11	RH Explosion relief assembly	4001287
12	Shrouds (2)	4002446
13	Burner module assembly NG	4002257S
	Burner module assembly LPG	4002258S
14	Ceramic burner platform	4002573
15	Window frame assembly (inc. glass)	4002259
16	Access panel gasket	4002664
17	Access plate	4002510
18	Top gasket	4002403
19	Side gaskets (2)	4002404
20	Bottom gasket	4002405
21	Thermocouple/pilot sealing plate	4002700
22	Double pipe sealing plate	4002699
23	Elbow connector	4002355
25	Front pipe assembly	4002485
26	Thermocouple interrupter	4001037
27a	GV60 valve assembly NG	4003099
27b	GV60 valve assembly LPG	4003112
29	34" flex pipe	4002475
30	Solenoid	4002250
31	Rear pipe assembly	4002486
32	Pilot Assembly NG	4001690
	Pilot Assembly LPG	4001691
33	Thermocouple	4000061
34	Pilot Injector #51 NG	4000735
	Pilot Injector #30 LPG	4000736
35	Pilot Tube	4000732
36	Pilot Hood 2 Flame	4000730
37	Extended Nut	4001855
38	Electrode	4001856
39	Insulation sleeve for ignition cable	4002244

Code	Description	Part Number
40	Injector nut	420K464
41	Air shutters (2)	4002590
42F	Front - Injector elbow #500 NG	4002606
	Front - Injector elbow #150 LPG	4002867
42R	Rear - Injector elbow #360 NG	4002607
	Rear - Injector elbow #280 LPG	4002866
43	Auxiliary battery holder	4002249
44	Ignition Cable	4001039
45	Switch with Cable	4001036
46	Cable Interrupter	4001035
47	Receiver G6R-R3AU (CP)	4002422
48	Handset G6R H3TV4-ZV1 (BJ)	4002251
49	Wiring Harness	4001187
50	Remote Control Wall Holder	9000008
51	Log Set Complete	4002610
52	RH middle log	4002683
53	RH base log	4002685
54	Center base log	4002686
55	LH base log	4002684
56	LH middle log	4002682
57	LH cross log	4002680
58	Rear log	4002681
59	RH cross log	4002679
60	Liner panels—complete set	
a	Ledgestone	786LSL
b	Enamel black	787EBL
c	Ceramic fluted black	788FBL
d	Valor red brick	789VRL
61	Top panel	
a	Ledgestone	4002368
b	Enamel black	4002374
c	Ceramic black	4002374
d	Valor red brick	4002385
62	Rear panel	
a	Ledgestone	4002367
b	Enamel black	4002373EB
c	Ceramic fluted black	4002379
d	Valor red brick	4002384

Spare Parts

Code	Description	Part Number
63	Left side panel	
a	Ledgestone	4002365
b	Enamel black	4002371EB
c	Ceramic fluted black	4002377
d	Valor red brick	4002382
64	Right side panel	
a	Ledgestone	4002366
b	Enamel black	4002372EB
c	Ceramic fluted black	4002378
d	Valor red brick	4002383
65	Hot glass warning plate	4003093

Spare Parts

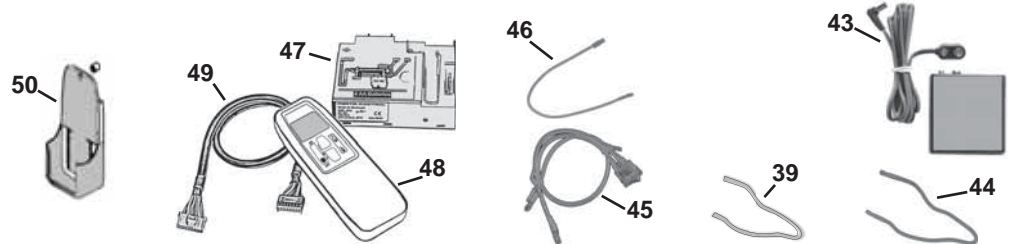
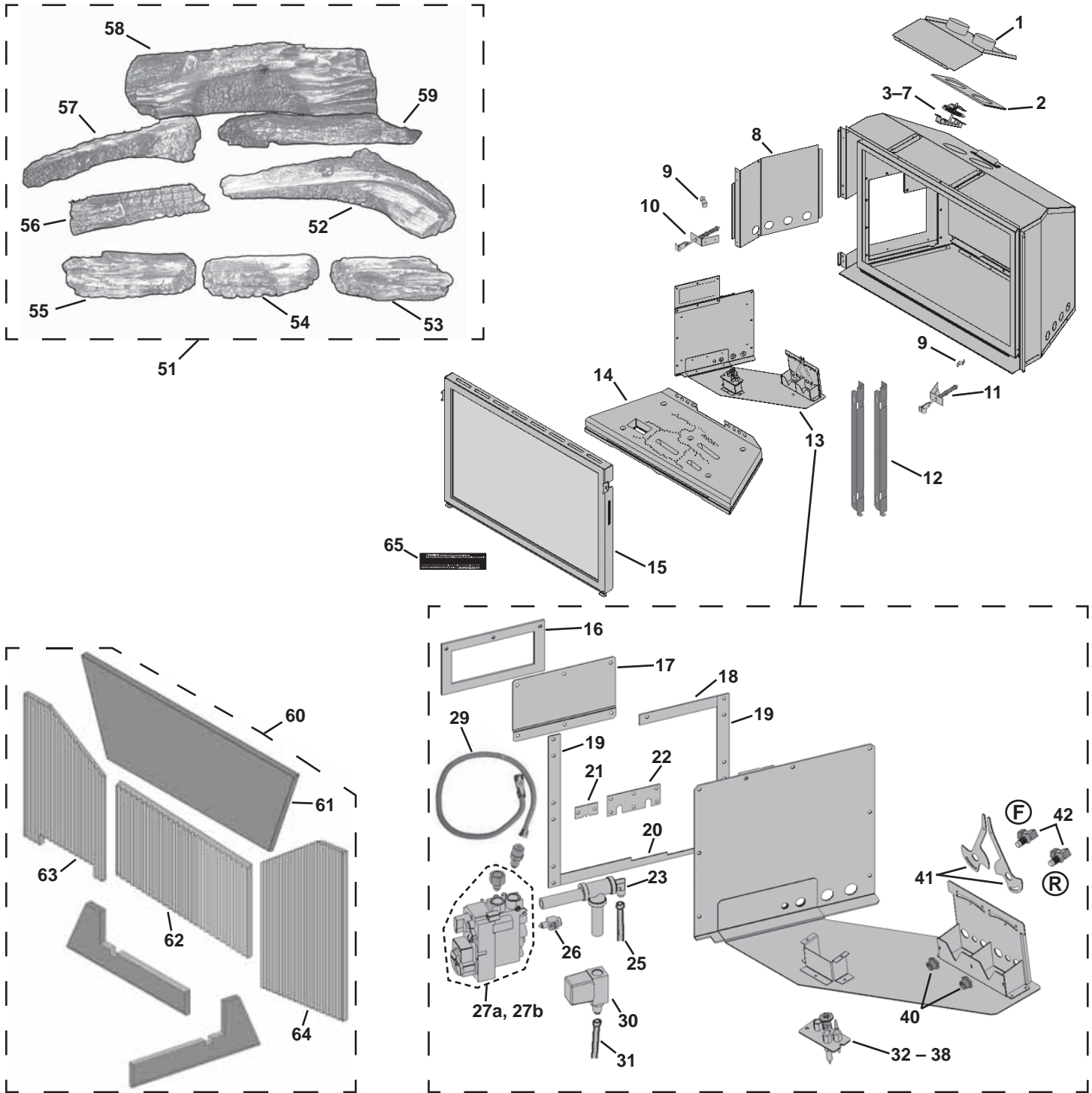

Thank You ...

For purchasing a Valor by Miles Industries. Your new radiant gas heater is a technical appliance that must be installed by a qualified installer.

Please fill in the information below. The information provided will be used for customer records only.



Fireplace Information

Model Number: 785 IN or IP

Serial Number:

Date Purchase (yyyy-mm-dd):

Dealer:

Customer Information

First Name:

Last Name:

Contact Information

Email:

Mailing Address

Address:

City:

Province/State:

Postal/Zip Code:

Country:

Cut out page, fill information, and mail to Miles Industries Ltd.

Online Warranty registration at www.valorfireplaces.com



Tape Shut



Fold here



Postage
needed

Miles Industries Ltd.
190 - 2255 Dollarton Highway
North Vancouver, BC V7H 3B1
Canada

Online Warranty registration at www.valorfireplaces.com



Thank you for choosing a Valor Product