



# valor



## DIRECT VENT WALL FURNACE

Model **134CN** For use with Natural Gas

Model **134CP** For use with LPG (Propane)

**WARNING:** If the information in this manual is not followed exactly, a fire or explosion may result causing property damage, personal injury or loss of life

- Do not store or use gasoline or other flammable vapors and liquids in the vicinity of this or any other appliance.
- **WHAT TO DO IF YOU SMELL GAS**
  - Open windows
  - Do not try to light any appliance.
  - Extinguish any open flame
  - Do not touch any electrical switch; do not use any phone in your building.
  - Immediately call your gas supplier from a neighbor's phone. Follow the gas supplier's instructions.
  - If you cannot reach your gas supplier, call the fire department.
- Installation and service must be performed by a qualified installer, service agency or the gas supplier.

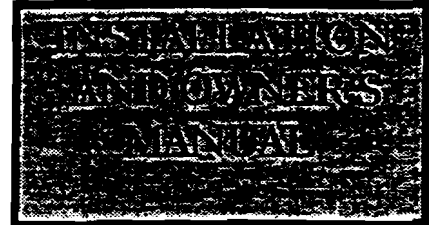

*Please read this manual before installing and operating the stove.*

This appliance is a domestic room heating appliance. It must not be used for any other purpose such as drying clothes etc.

Vous pourrez vous procurer un exemplaire en langue Française de cette brochure chez votre concessionnaire

600A538/03

# CONTENTS

	Page
Safety information.....	3
General requirements.....	4
Specifications.....	4
Installation.....	4
• Location in room.....	4
• Vent location.....	5
• Furnace pack contents.....	6
• Wall preparation.....	6
• Furnace installation.....	7
• Gas line installation.....	9
• Manifold pressure check.....	9
• Final installation.....	9
Owner's information.....	10
• Cleaning.....	10
• Periodic checks.....	10
• Servicing.....	10
• Lighting instructions.....	11

## 1. SAFETY INFORMATION

Due to high temperatures, the appliance should be located out of traffic and away from furniture and draperies.

Children and adults should be alerted to the hazards of high surface temperatures and should stay away to avoid burns or clothing ignition.

Young children should be carefully supervised when they are in the same room as the appliance.

Clothing or other flammable material should not be placed on or near the appliance.

**WARNING:** Do not operate the appliance with the pilot viewing glass panel removed, cracked or broken. Replacement of the panel should be done by a licensed or qualified service person.

This appliance should be installed and repaired by a qualified service person.

The appliance should be inspected before use and at least annually by a professional service person. More frequent cleaning may be required due to excessive lint from carpeting, bedding material, etc. It is imperative that control compartments, burners and circulating air passageways of the appliance are kept clean.

Keep curtains, clothing, furniture and other flammable materials at least 36ins (90cm) from all parts of the appliance.

Keep the appliance area well clear and free from combustible materials, gasoline and other flammable vapors and liquids.

Keep the base of the appliance clear to prevent obstruction of air flow to the appliance.

The vent terminal on the outside wall must be kept free from obstructions. The terminal is hot during operation and requires a guard (Part #235) if it is accessible to any person. No objects should be placed within 2 feet (60cm) of the vent terminal.

During extreme weather conditions ensure that the vent outlet is free from ice and snow before attempting to light.

Do not use this appliance if any part has been under water. Immediately call a qualified service technician to inspect the appliance and to replace any part of the control system and any gas control which has been under water.

### NOTE

When operating your new appliance for the first time, some vapors may be released which may cause a slight odor and could possibly set off any smoke detection alarms in the immediate vicinity. These vapors are quite normal on new appliances. They are totally harmless and will disappear after a few hours use.

## 2. GENERAL REQUIREMENTS & SPECIFICATIONS

### 2.1. Installation requirements.

This appliance is certified by International Approval Services for use in Canada and the USA. The appliance is for installation directly venting through an outside wall.

The installation must conform with local codes or, in the absence of local codes, with the current CAN/CGA-B149.1 installation code in Canada or the current National Fuel Gas Code, ANSI Z223.1 in the USA. Only qualified licensed or trained personnel should install the appliance.

Model 134CN is for Natural Gas.

Model 134CP is supplied set for use with LPG and with a conversion kit for Natural Gas. This model may be installed in a manufactured home (Mobile home): In Canada Installation in a mobile home must conform with the current standard CSA Z240.4 (Gas Equipped Recreational Vehicles and Mobile Housing). In the USA Installation in a mobile home must conform with the current edition of the Manufactured Home Construction and Safety Standard, Title 24 CFR, Part 3280, or, when such a standard is not applicable, the Standard for Manufactured Home Installations, ANSI A225.1/NFPA 501A.

### 2.2. Specifications

(The rating plate is located inside on the right side of the back panel visible when the outer case is removed for installation or servicing.)

	Natural Gas	LPG (Propane)
Inlet Pressure min.	5" w.c.	10.5" w.c.
Inlet Pressure max.	10.5" w.c.	14" w.c.
Manifold pressure min.	3.8" w.c.	9.3" w.c.
Manifold pressure max.	4.2" w.c.	9.7" w.c.
Heat input min.	3800Btu/h	
Heat input max.	9000Btu/h	
Heat output max.	6930Btu/h	
Wall thickness min.	3 1/2"	
Wall thickness max.	19 1/2"	
Supply pipe connection	1/2" NPT	
Main burner injector	.057" orifice (marked 144)	.035" orifice (marked 110)
Pilot burner injector	.009" orifice (marked 34)	.01" x .024" orifice (marked 19)

## 3. LOCATION

### 3.1 Location in room

The space required for the furnace and minimum clearances are shown in figure 1.

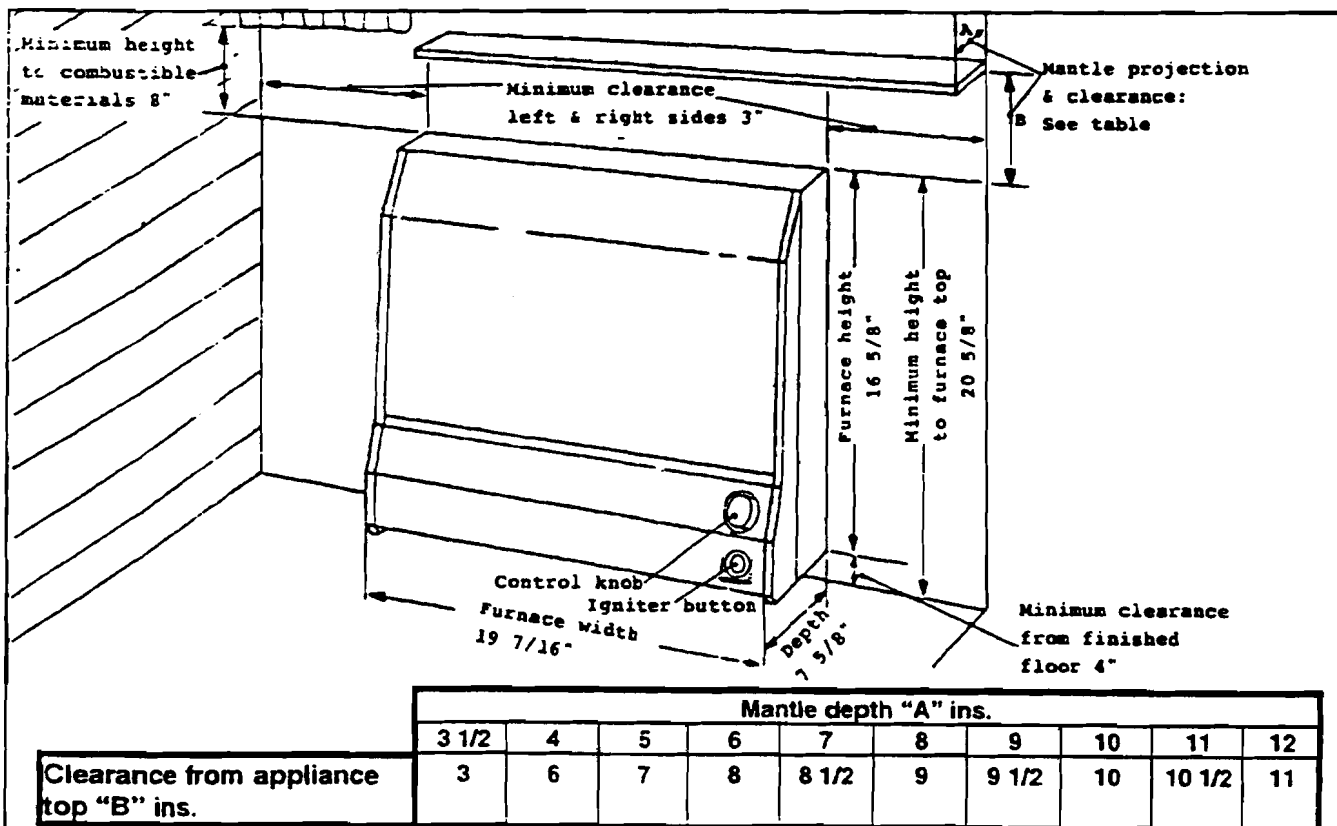

Fig. 1 Appliance dimensions & clearances to combustible materials

**3.2 Vent location**

- 3.2.1 The vent terminal must be located on an outside wall.
- 3.2.2 The vent clearance hole required in the wall is 7 3/8" diameter.
- 3.2.3 The center of the vent hole must be at least 15 1/4" above the finished floor level in order to satisfy the minimum clearance from the bottom of the furnace.
- 3.2.4 Do not use any vent unit other than that supplied with this appliance.
- 3.2.5 This direct vent appliance is designed to operate when an undisturbed air flow hits the outside vent terminal from any direction. The minimum clearances from this terminal which must be maintained are shown in figure 2. Any reduction in these clearances could result in a disruption of the air flow or a safety hazard. Local codes or regulations may require greater clearances.

- 3.2.6 The terminal, when installed with the vent shield tube and wall plates, is suitable for mounting on wood or vinyl siding without requiring additional shielding.
- 3.2.7 The slots in the vent terminal must not be recessed into a wall or siding.
- 3.2.8 The vent terminal should be positioned where it will not be covered by any snowdrifts.
- 3.2.9 **Warning:** If the outside vent terminal is located where it will be accessible to any person, a guard must be fitted over the terminal to prevent damage and to prevent it being touched. The vent terminal becomes very hot when the appliance is in use and can cause burns. A special guard designed for this appliance is available from your supplier - Ask for Valor part #235 (See figure 3).

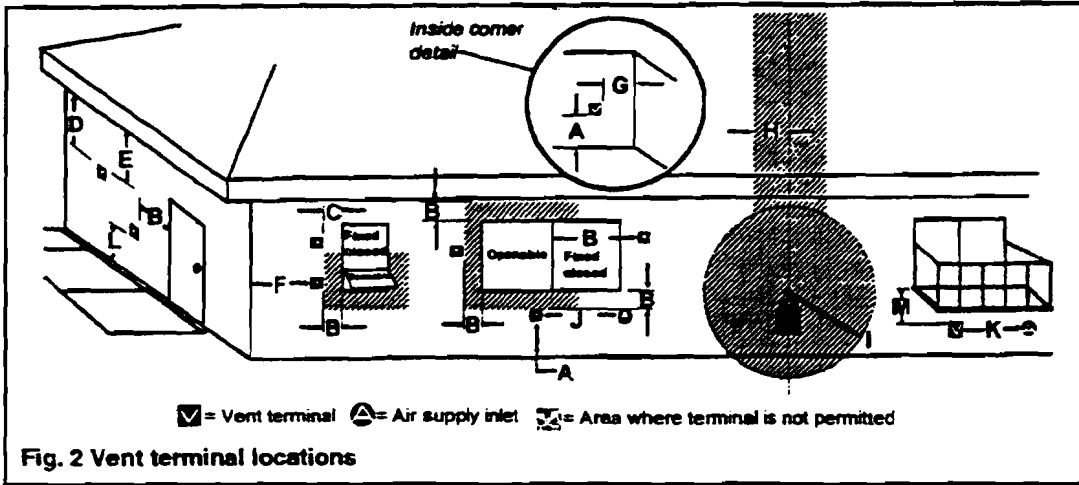

Fig. 2 Vent terminal locations

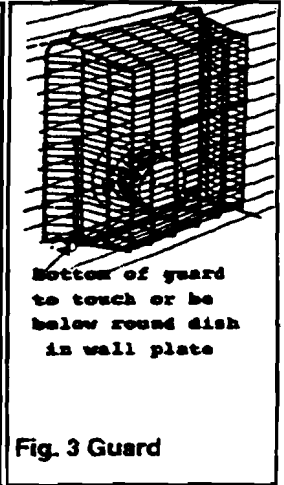

Fig. 3 Guard

KEY	VENT TERMINAL LOCATIONS - MINIMUM DISTANCES <i>See figure 2</i>	MINIMUM CLEARANCE	
		Ins	Cms
A	Clearance above grade, verandah, porch, deck or canopy	12	30
B	Clearance to window or door that may be opened	12	30
C	Clearance to permanently closed window (recommended to prevent condensation on window)	12	30
D	Vertical distance to ventilated soffit located above the terminal within a horizontal distance 2 feet (60cm)	18	46
E	Clearance to unventilated soffit	12	30
F	Clearance to outside corner	12	30
G	Clearance to inside corner	12	30
H	Horizontal clearance to center-line of meter/regulator assembly located below the terminal	36	90
I	Clearance to service regulator vent outlet	72	180
J	Clearance to non-mechanical air supply inlet to the building or the combustion air inlet to any other appliance	12	30
K	Clearance to a mechanical air supply inlet	72	180
L	Clearance above paved sidewalk or a paved driveway located on public property. <i>Note: A vent must not terminate directly above a sidewalk or paved driveway which is located between two single family dwellings and serves both dwellings.</i>	84	210
M	Clearance under a verandah, porch, deck or balcony	12	30

**Note:** Local codes and regulations may require different clearances.

## 4. PACK CONTENTS

The pack for Both 134CN and 134CP types contains the following:-

- 1 Wall furnace complete.
- 1 Vent terminal unit with sealing tape wrapped round outside.
- 1 Styrofoam support (For vent tube cutting).
- 1 Outer vent shield.
- 3 Wall plates.
- 1 Sealing ring
- 1 Wall mounting strip - right side.
- 1 Wall mounting strip - left side with chained instruction plate.
- 1 1/2"NPT inlet connector.
- 1 Wall drilling template.
- 12 Wood screws (for wall plates, mounting strips & furnace fixing).

12 Wall plugs (for wall plates, mounting strips & furnace fixing).

5 Machine screws (for vent shield).

5 Nuts (for vent shield).

The pack for model 134CP also contains the following parts for converting from LPG to Natural Gas:-

- 1 Main burner injector.
- 1 Pilot burner injector.
- 1 Thermostat bypass screw
- 1 Washer for main burner injector.
- 4 Strip seals for heat exchanger cover.
- 1 Appliance data conversion label.

Take care when removing the contents from the packaging to prevent damage. Check that all the contents are in the packs and are undamaged.

## 5. WALL PREPARATION

### Important:

the center of the vent hole must be at least 15 1/4" above the finished floor level so that there is a minimum clearance of 4" below the bottom of the appliance. Be aware also that the center line of the furnace will be 1 1/16" offset to the right of the center of the vent hole in the wall (See template). Before cutting the vent opening in the wall, make sure that the installed position of the appliance will be satisfactory. Once the vent opening in the wall is cut it will not be possible to alter the position of the appliance without re-cutting the wall.

- 5.1 Place dust sheets on the floor and over any furnishings etc. in the vicinity.
- 5.2 Place the template against the wall so that the center line and height of the furnace are in the correct positions. Mark through the template onto the wall the centers of the vent hole and 4 furnace mounting holes. Remove the template.
- 5.3 Cut 7 3/8" diameter vent hole through the wall making sure that it is straight and level.
- 5.4 Place one of the wall plates against inside face of the wall with the dished projection seated inside the hole in the wall.
- 5.5 Mark the wall plate fixing holes. Remove the plate.
- 5.6 Drill the plate fixing holes in the wall. Insert wall plugs if necessary (wall plugs require 1/4" hole).
- 5.7 Replace the plate in the wall. Fix the plate to the wall with the four screws provided (Figure 4).

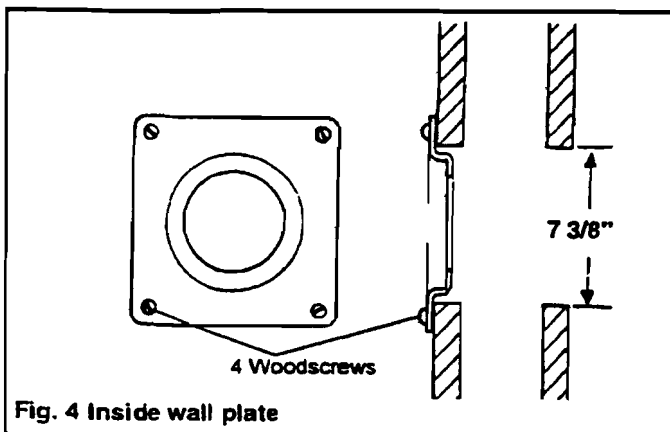

5.8 Measure the total wall depth from its outside surface to the finished surface in the room.

5.9 Flatten the outer vent shield tube. The tube is supplied coiled around the vent terminal unit. Cut the tube exactly to the total wall depth. Make sure that the cutting line is at least 1" away from the nearest bolt hole (see figure 5).

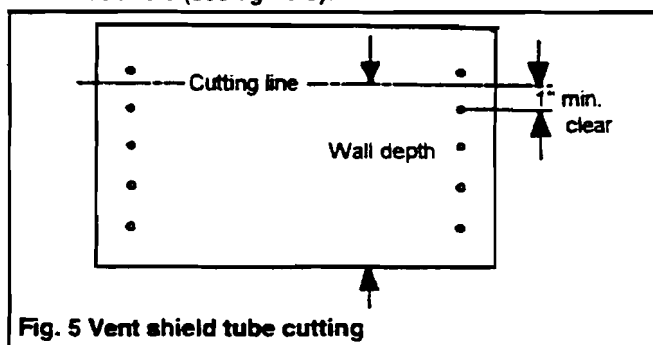

5.10 Form the shield into a tube with the holes aligned. Fasten using the #10 bolts and nuts provided with the bolt heads outside.

5.11 Insert the shield tube into the wall from the outside wall. Push the tube firmly in so that it locates fully over the dished diameter of the inside wall plate. Trim the tube if necessary (see figure 6). The outside end of the tube can be temporarily held in place by inserting wedges of cardboard, wood etc. round the wall hole to prevent tilting.

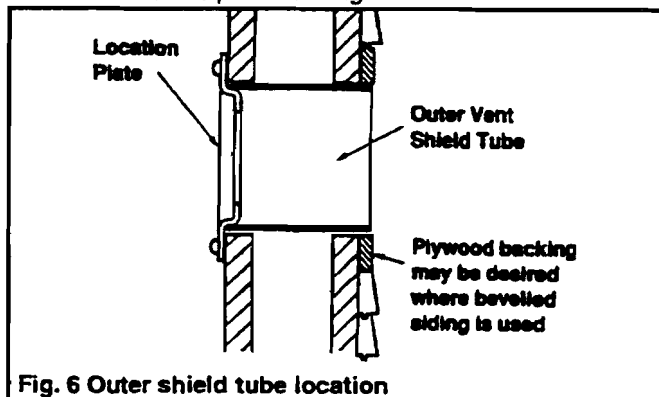

- 5.12 Drill the furnace mounting holes at the marked positions. Insert wall plugs if necessary (wall plugs require 1/4" hole).
- 5.13 Place the right side wall mounting strip in position with the locating ear at the top and so that its two holes line up with the holes in the wall (see figure 7). Insert a wood screw through the upper hole. Make sure that the lower hole in the strip lines up with the hole in the wall. Tighten the screw in the upper hole firmly so that the strip will not rotate.
- 5.14 Fit the left side wall mounting strip (Strip with chained instruction plate) in the same manner.

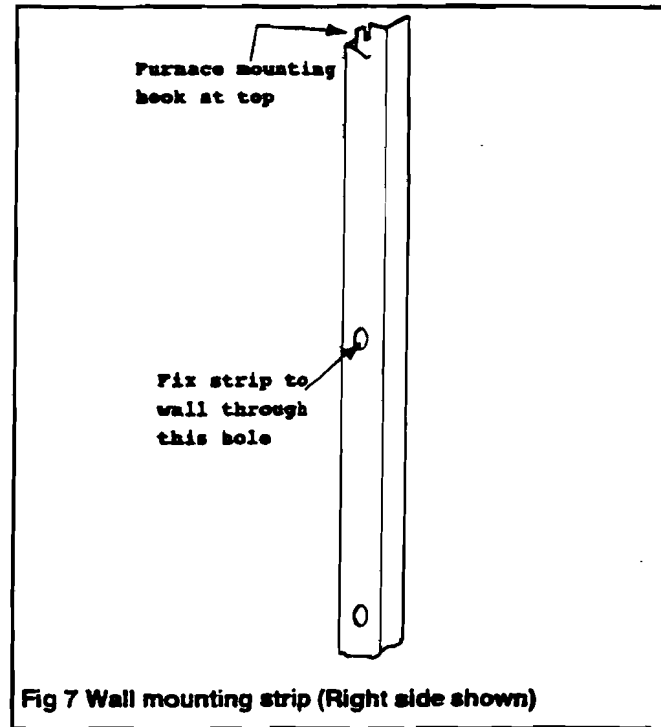

Fig 7 Wall mounting strip (Right side shown)

## 6. FURNACE INSTALLATION

- 6.1 Detach the igniter wire from the igniter button unit inside bottom of furnace.
- 6.2 Remove the case securing screws at the bottom rear corners of the case.
- 6.3 Remove the outer case. First lift the bottom of the case clear of the controls and then lift the case clear of the locations at the top rear.
- 6.4 Mark the vent terminal at the length of *total wall depth plus 1 1/2"* measured from the *inside edge* of the vent cap (see figure 8). Insert the Styrofoam support ring and push it as close to the marked position as possible. Cut off the vent tubes squarely at the marked position. Make sure that all Styrofoam is removed from the vent unit after cutting.
- 6.5 Fit the vent unit to the furnace collars. The nuts & screws on the vent unit should be uppermost. Push the vent unit on firmly as far as it will go (up to the screw stops inside the furnace outer collar).
- 6.6 Seal the vent unit to the outer collar with the tape supplied wrapped round the vent unit (see figure 9).

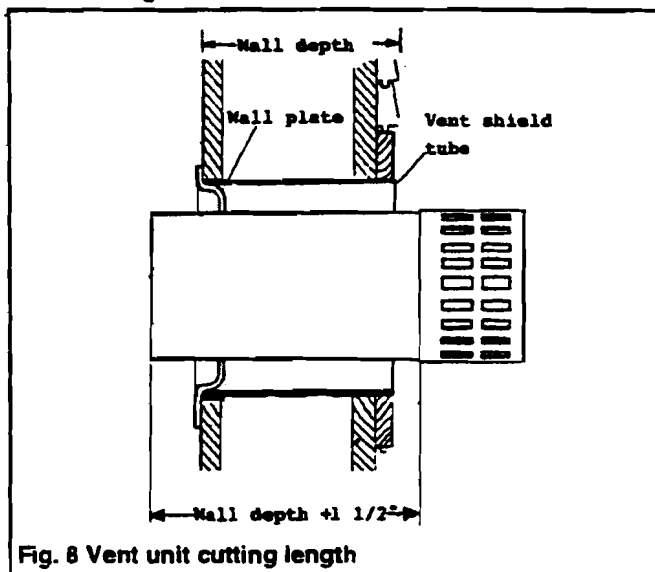

Fig. 8 Vent unit cutting length

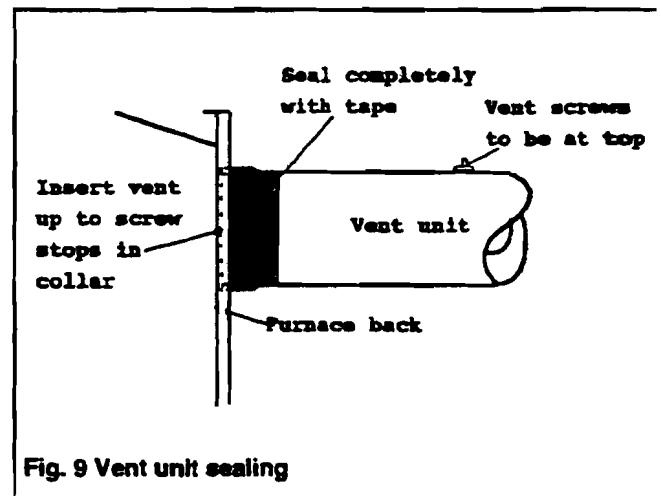

Fig. 9 Vent unit sealing

- 6.7 Lift the furnace & vent unit. Insert the vent unit into the cavity in the wall. Push the furnace up to the wall mounting strips. The hooked ears at the top of the wall mounting strips must pass through the keyholes near the top each side of the furnace back panel (Slightly tilt the furnace if necessary to engage the ears). Let go of the furnace so that it hangs from the hooked ears. (see figure 10).

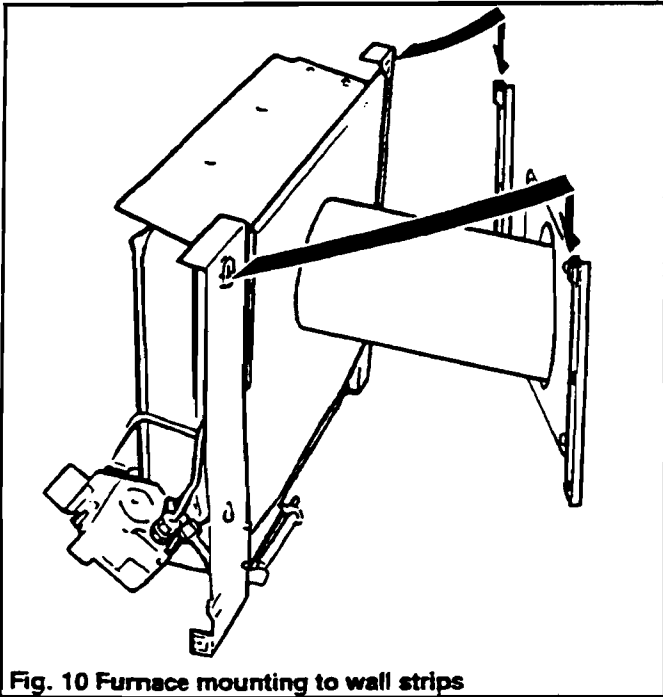

Fig. 10 Furnace mounting to wall strips

- 6.8 Secure the furnace to the wall with two wood screws. Fit a wood screw through each of the holes about 5" up from the bottom of the furnace back. The screws should pass through the lower holes in the wall mounting strips and into the wall (see figure 11).

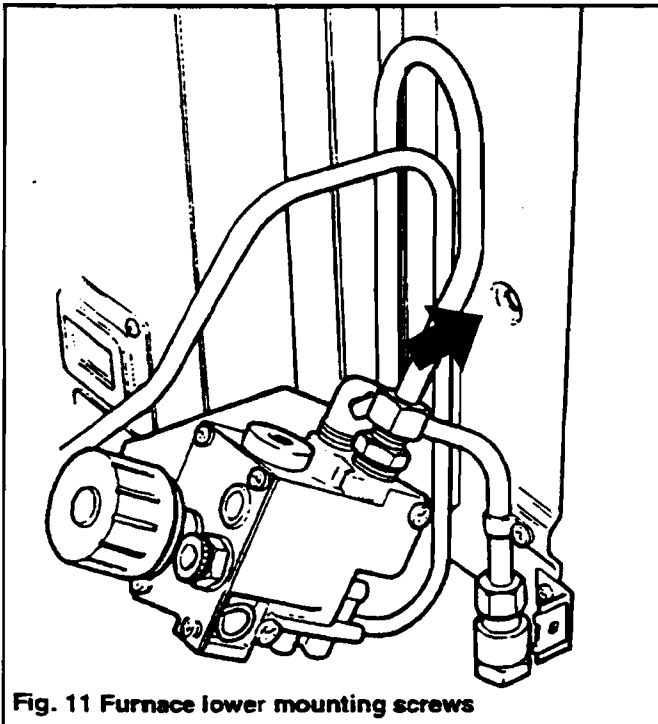

Fig. 11 Furnace lower mounting screws

- 6.9 Place a wall plate over the outside wall end of the terminal with the dished projection facing inside. Push the plate up to the wall so that the dished projection locates inside the vent shield tube (see figure 12). Mark the wall plate fixing holes on the wall. Remove the plate.
- 6.10 Drill the fixing holes in the wall and insert plugs if necessary.
- 6.11 Replace the wall plate locating it firmly inside the shield tube.
- 6.12 Fit the sealing ring over the vent unit and push into the wall plate.
- 6.13 Fit the remaining wall plate over the vent unit with the dished projection facing outwards. Line up the screw holes and start the fixing screws. Apply a clear silicone rubber sealant under the edges of the wall plates and tighten the screws. Apply a bead of sealant round the vent tube where it exits the wall plate (see figure 12).

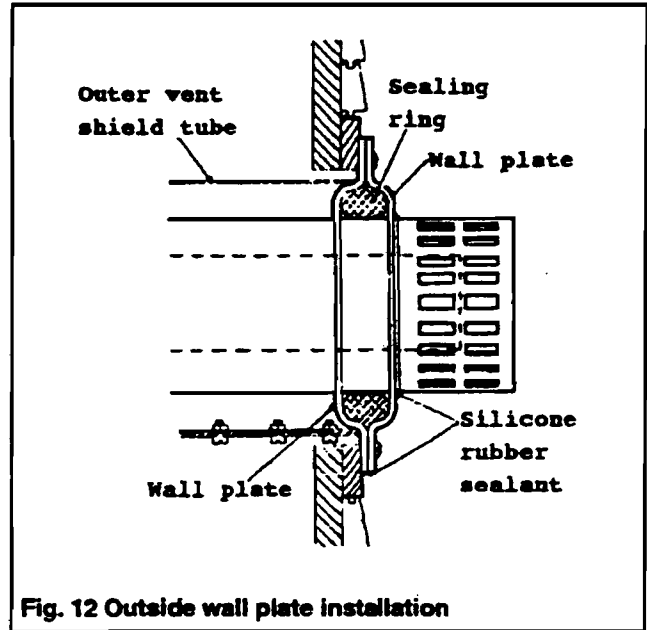

Fig. 12 Outside wall plate installation



## 7. GAS LINE INSTALLATION & CHECKS

- 7.1 Connect the 1/2"NPT inlet connector to the furnace inlet pipe at the bottom right of the appliance.
- 7.2 Route the gas supply line to the inlet connection connector.
- 7.3 Use only new black iron or steel pipes or copper tubing if acceptable - check local codes. *Note that in USA copper tubing must be internally tinned for protection against sulfur compounds.*
- 7.4 Unions in gas lines should be of ground joint type.
- 7.5 The gas supply line must be sized and installed to provide a supply of gas sufficient to meet the maximum demand of the appliance without undue loss of pressure.
- 7.6 Sealants used must be resistant to the action of all gas constituents including LP gas. Sealants should be applied lightly to male threads to ensure excess sealant does not enter gas lines.
- 7.7 The supply line should include a manual shut-off valve to allow the appliance to be disconnected for servicing.
- 7.8 A plugged 1/8"NPT tapping must be installed in the line. The tapping must be accessible for test gauge connection and be immediately upstream of the gas supply connection to the appliance.
- 7.9 Pressure test the supply line.
  - The appliance and its individual shut-off valve must be disconnected from the gas supply piping system during any pressure testing of that system at test pressures in excess of 1/2psig (3.5kPa).
  - The appliance must be isolated from the gas supply piping system by closing its individual manual shut-off valve during any pressure testing of the gas supply piping system at test pressures equal to or less than 1/2psig (3.5kPa).
  - Failure to either disconnect or isolate the appliance during pressure testing may result in regulator or valve damage. Consult your dealer in this case.
- 7.10 All piping and connections must be tested for leaks after installation or servicing. All leaks must be corrected immediately.

When testing for leaks:

  - Make sure that the control knob is at the "Off" position.
  - Open the manual shut-off valve.
  - Test for leaks by applying a liquid detergent or soap solution to all joints. Bubbles forming

indicate a gas leak. **Never use an open flame to check for leaks.**

- Correct any leak detected immediately.

### 7.11 Check manifold pressure.

- 7.11.1 The burner manifold pressure is controlled by regulator within the thermostat unit. The correct pressure range is shown in the table in section 2 of this manual. Check pressure as follows.
- 7.11.2 Move outer case close to furnace and reconnect the ignition wire to the igniter button unit.
- 7.11.3 Fit manometer to manifold pressure test tapping point. Tapping is the point nearest the front at bottom of thermostat unit (see figure 13).
- 7.11.4 Turn control to Pilot. Press igniter button to light pilot then turn to "Hi".
- 7.10.5 The manifold pressure should be within the limits shown in the table in section 2 of this manual.
- 7.11.6 If pressure is outside the limits, adjust by turning the regulator screw located at the top of the thermostat (see figure 13).

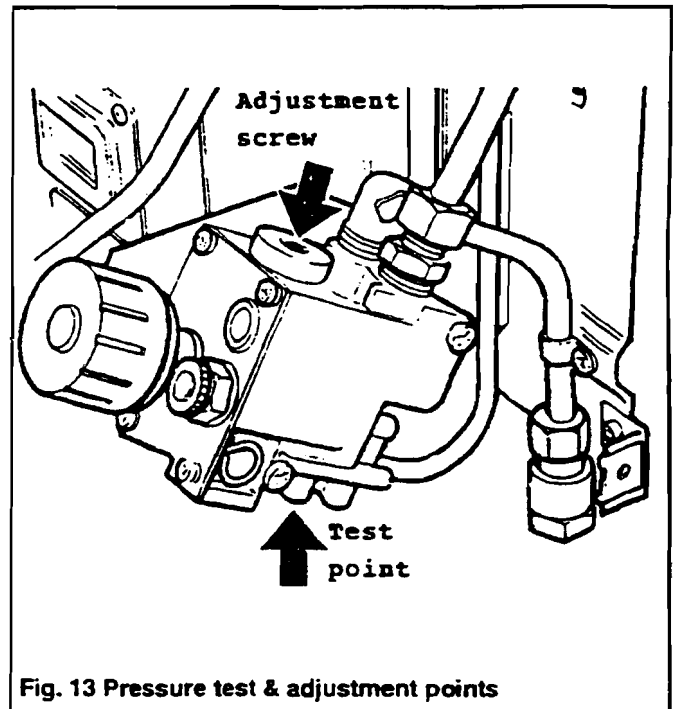

Fig. 13 Pressure test & adjustment points

## 8. FINAL INSTALLATION & CHECKS

- 8.1 Detach the igniter wire from the igniter button.
- 8.2 Refit the outer case over the furnace. Refit and tighten the screws at the bottom corners.
- 8.3 Reconnect the igniter wire to the igniter button.
- 8.4 Check ignition and thermostat control operation (See owner's lighting instructions further on in this manual).
- 8.5 Instruct the owner how to operate the appliance.
- 8.6 Recommend that the appliance is inspected and, if necessary, serviced at least once a year.
- 8.7 Point out the location of the supply shut off valve and its operation.
- 8.8 Point out the location of the vent terminal. Advise that, for safe and efficient operation, no objects should be placed within 2 feet (60cm) of the vent terminal.

## 9. OWNER'S INFORMATION

*The operating instructions are also on a label chained to the back of the furnace.*

### 9.1 Safety device

For your safety this appliance is fitted with a flame supervision device which will shut off the gas supply if, for any reason, the pilot flame goes out. This device incorporates a fixed probe which senses the heat from the pilot flame. If the probe is cool, the device will prevent any gas flow unless the gas control knob is kept pushed in at the pilot position. See full lighting instructions on next page.

### 9.2 Cleaning

Only clean when the furnace is cold.

The front cover must be cleaned at least twice a year to make sure that there is not any build up of lint etc. over the holes.

The rest of the appliance should only need occasional wiping with a clean damp cloth and mild detergent. Dry and polish with a soft cloth.

Do not use abrasive cleaners on any part of the furnace.

### 9.3 Checks

A periodic check of the flame should be made by looking through the pilot viewing window. See the illustration in the lighting instructions on the next page.

9.3.1 The appliance area must always be kept clear and free from combustible materials, gasoline and other flammable vapors and liquids.

9.3.2 the vent terminal outdoors should be inspected regularly to make sure that it is not obstructed by dirt, snow, insects, leaves etc.

9.3.3 The whole vent system should be checked regularly by a qualified service person. We recommend annually.

If detached, the vent-air intake system must be properly reassembled and resealed by a qualified service person as described in the installation section of this manual.

### 9.4 Servicing

If you require any attention to your appliance, contact your supplier quoting the model number.

The repair parts are shown in the separate repair parts leaflet. Please always quote part number and description when requesting spare parts.

## FOR YOUR SAFETY READ BEFORE LIGHTING

**WARNING:** If you do not follow these instructions exactly, a fire or explosion may result causing property damage, personal injury or loss of life.

- A. This appliance has a pilot which must be lighted by hand. When lighting the pilot, follow these instructions exactly.
- B. **BEFORE LIGHTING** smell all round the appliance area for gas. Be sure to smell next to the floor because some gas is heavier than air and will settle on the floor.

### WHAT TO DO IF YOU SMELL GAS

- Do not try to light any appliance.
  - Do not touch any electric switch; do not use any phone in your building.
  - Immediately call your gas supplier from a neighbor's phone. Follow the gas supplier's instructions.
  - If you cannot reach your gas supplier, call the fire department.
- C. Use only your hand to push in or turn the gas control knob. Never use tools. If the knob will not push in or turn by hand, don't try to repair it, call a qualified service technician. Force or attempted repair may result in a fire or explosion.
- D. Do not use this appliance if any part has been under water. Immediately call a qualified service technician to inspect the appliance and to replace any part of the control system and any gas control which has been under water.

## LIGHTING INSTRUCTIONS

1. STOP! Read the safety information above.
2. Turn the control knob clockwise ↻ to "OFF"
3. Wait five (5) minutes to clear out any gas. If you then smell gas, STOP! Follow "B" in the safety information above. If you don't smell gas, go to next step.
4. Find the pilot. It is behind the front case grille towards the bottom right corner.
5. Turn the control knob counterclockwise ↺ "PILOT" and depress knob.
6. Keep control knob depressed and push in igniter button. This should ignite pilot.
7. Keep control knob depressed for a further ten (10) seconds then release. The pilot should remain alight. If pilot does not light or remain alight, repeat steps 2 through 7.
  - If knob does not pop up when released, stop and immediately call your service technician or gas supplier.
  - If pilot will not stay lit after several tries, turn the gas control knob to "OFF" and call your service technician or gas supplier.
8. When pilot is alight, turn control knob counterclockwise ↺ to desired setting between "LO" and "HI".

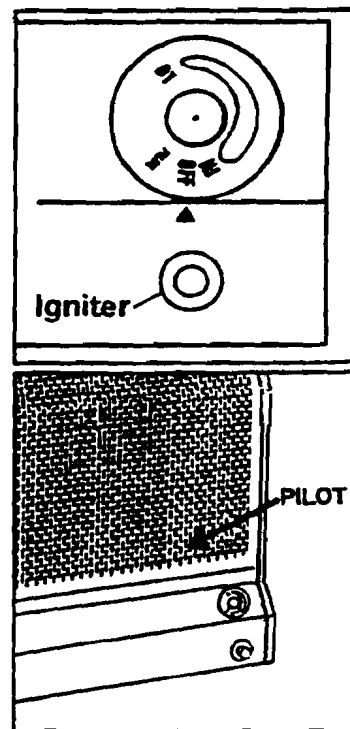

## TO TURN OFF GAS TO APPLIANCE

Turn the control knob clockwise ↻ to "OFF". Do not force.