

Installation Manual



G3

Direct Vent Gas Fireplace Insert
Gas Fireplace
natural gas 739VN
propane gas 739VP

with
AutoFire™

Canadian Patent 2,717,779 Issued October 24 2017
US Patent 10,060,624 Issued August 28 2018
US Patent 10,935,246 Issued March 2 2021

Installer: Place model/serial number here.

Installer: Leave this manual with the appliance.
Consumer: Retain this manual for future reference.

⚠ WARNING:
FIRE OR EXPLOSION HAZARD
Failure to follow safety warnings exactly could result in serious injury, death, or property damage.

Do not store or use gasoline or other flammable vapors and liquids in the vicinity of this or any other appliance.

WHAT TO DO IF YOU SMELL GAS

- Do not try to light any appliance.

- Do not touch any electrical switch; do not use any phone in your building.
- Leave the building immediately.
- Immediately call your gas supplier from a neighbor's phone. Follow the gas supplier's instructions.
- If you cannot reach your gas supplier, call the fire department.

Installation and service must be performed by a qualified installer, service agency or the gas supplier.

⚠ DANGER



Hot glass will cause burns.
Do not touch glass until cooled.
Never allow children to touch glass.

A barrier designed to reduce the risk of burns from the hot viewing glass is provided with this appliance and must be installed for the protection of children and other at-risk individuals.

This appliance may be installed in an after-market permanently located, manufactured (mobile) home where not prohibited by local codes. This appliance is only for use with the type of gas indicated on the rating plate. This appliance is not convertible for use with other gases, unless a certified kit is used.

INSTALLER: Leave this manual with the appliance.
CONSUMER: Retain this manual for future reference.

Massachusetts:

The piping and final gas connection must be performed by a licensed plumber or gas fitter in the State of Massachusetts. Also, see Carbon Monoxide Detector requirements in this manual, page 35.

⚠ WARNING

This product can expose you to chemicals including Benzene, which is known to the State of California to cause cancer and birth defects or other reproductive harm. For more information go to www.P65Warnings.ca.gov.

Note: Natural gas, in its original state, contains Benzene.

This appliance is a domestic room-heating appliance. It must not be used for any other purposes such as drying clothes, etc.

This appliance is suitable for installation in a bedroom or bed sitting room.

Ce guide est disponible en français sur demande.



We recommend a US Certified National Fireplace Institute (NFI) specialist install our gas hearth products.



The information contained in this manual is believed to be correct at the time of printing. Miles Industries Ltd. reserves the right to change or modify any information or specifications without notice. Miles Industries Ltd. grants no warranty, implied or stated, for the installation or maintenance of your heater, and assumes no responsibility for any consequential damage(s).

© Copyright Miles Industries Ltd., 2023. All rights reserved.
Designed and manufactured for Miles Industries Ltd.

Welcome to Valor®

This appliance has been professionally installed by:

Dealer Name: _____

Phone: _____

Please read this manual BEFORE installing and operating this appliance.

| | |
|--|-----------|
| Fireplace Safety | 4 |
| Specifications | 6 |
| Kits and Accessories..... | 7 |
| Dimensions and Cavity..... | 8 |
| Clearances | 9 |
| Installation Planning..... | 10 |
| Before Installation | 10 |
| Concept | 11 |
| Venting..... | 12 |
| Preparation | 14 |
| Existing Fireplace | 14 |
| Installation | 15 |
| Window and Fan..... | 15 |
| Venting System and Appliance | 16 |
| Gas Supply..... | 17 |
| Liner Panels | 18 |
| Fuel Beds | 20 |
| Birch Log Kit 739VBLK | 20 |
| Driftwood Kit 739VDWK..... | 23 |
| Traditional Log Kit 739VLSK..... | 26 |
| Window Re-Installation and Verification..... | 29 |
| Batteries and Remote Control..... | 30 |
| Operation and Aeration Verification | 31 |
| Accessories | 32 |
| Side Shrouds | 32 |
| Front, Trim and Barrier Screen | 32 |
| Handset Wall Holder | 32 |
| Wiring Diagram..... | 33 |
| Approved Venting Components | 34 |
| Commonwealth of Massachusetts | 35 |
| Appendix A - Lighting Instructions Plate..... | 36 |
| Appendix B - Remote Control Operation | 37 |
| Appendix C - Spare Parts..... | 41 |

Fireplace Safety

This manual contains very important information about the safe installation and operation of the fireplace. Read and understand all instructions carefully before installing and operating the fireplace. Failure to follow these instructions may result in possible fire hazard and will void the warranty.

Replacement manuals are available by contacting the Valor Customer Service at 1-800-468-2567, or by visiting valorfireplaces.com.

WARNING: Extremely Hot!

Heat and flammability

- Some parts of the fireplace are extremely hot, particularly the glass window. Use the barrier screen provided or a gate to reduce the risk of severe burns.
- The glass windows can exceed 500°F at full capacity.
- Always keep the appliance clear and free from combustible materials, gasoline, and other flammable vapors and liquids.
- Be aware of hot wall surfaces! The wall directly above the fireplace can get very hot when the fireplace heats. Although safe, it may reach temperatures in excess of 200°F (93°C) depending on choice of optional accessories. Do not touch!
- Be aware of hot shelf/hearth/floor surfaces! Any projections directly around the fireplace can get very hot when the fireplace heats. Although safe, they may reach temperatures in excess of 200°F (93°C) depending on their elevation. Be careful of touching these! Do not put objects on the hearth or shelf. Temperature of projection surfaces will be reduced when barrier screen is installed.
- Some materials or items, although safe, may discolor, shrink, warp, crack, peel, and so on because of the heat produced by the fireplace. Avoid placing candles, paintings, photos and other combustible objects sensitive to heat or furniture within 36 inches (0.9 m) around the fireplace.
- Solid wood flooring in front of the fireplace (if allowed) may shrink during the heating season due to heat.
- Due to high temperatures, the appliance should be located out of traffic areas and away from furniture and draperies.
- Clothing or other flammable material should not be placed on or near the appliance.

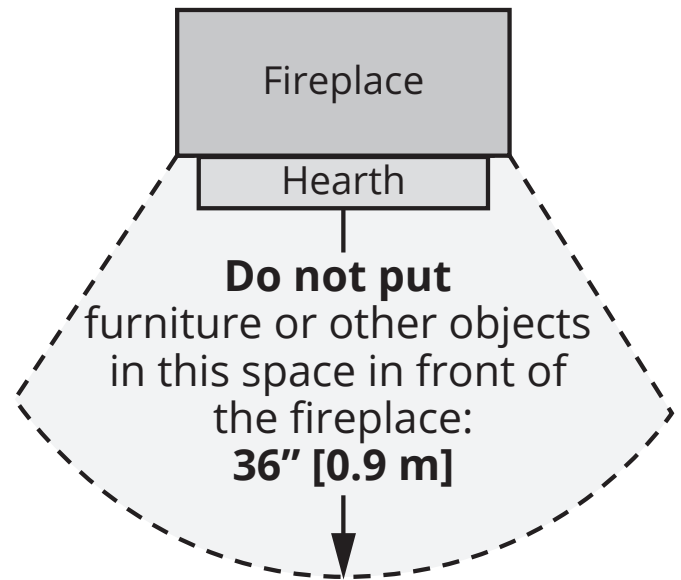

Barrier Screen and Safety

- A barrier designed to reduce the risk of burns from the hot viewing glass is provided with this appliance and must be installed for the protection of children and other at-risk individuals.
- Children and adults should be alerted to the hazards of high surface temperature and should stay away to avoid burns or clothing ignition.
- Young children should be carefully supervised when they are in the same room as the appliance. Toddlers, young children, and others may be susceptible to accidental contact burns. A physical barrier is recommended if there are at-risk individuals in the house. To restrict access to a fireplace or stove, install an adjustable safety gate to keep toddlers, young children, and other at-risk individuals out of the room and away from hot surfaces.
- Any safety screen, guard, or barrier removed for servicing an appliance, must be replaced prior to operating the appliance.

Fireplace Safety

Glass window



WARNING

Do not operate this appliance with the glass front removed, cracked, or broken.

Do not strike or slam the glass front.

Replacement of the glass front should be performed by a licensed or qualified service person.

- The glass front assembly must be in place and sealed before the unit can be placed into safe operation.
- The glass front assembly must only be replaced as a complete unit, as supplied by the fireplace manufacturer. No substitute material may be used.
- Do not use abrasive cleaners on the glass front assembly. Do not attempt to clean the glass when it is hot.

Venting

- This unit must be used with a vent system as described in this manual. No other vent system or components may be used.
- Never obstruct the flow of combustion and ventilation air. Keep the front of the appliance clear of all obstacles and materials for servicing and proper operation.
- This gas fireplace and vent assembly must be vented directly to the outside and must never be attached to a chimney serving a separate solid fuel burning appliance. Each gas appliance must use a separate vent system. Common vent systems are prohibited.

Intended use

- This appliance is designed and approved as a supplemental heater and provides the potential for most energy conservation when used while attended. The use of an alternate primary heat source is advisable.
- This unit is not for use with solid fuel.
- Do not use this heater as a temporary source of heat during construction.

Installation and Servicing

- Installation and repair should be done by a qualified service person. The appliance should be inspected before use and at least annually by a professional service person. More frequent cleaning might be required due to excessive lint from carpeting, bedding material, et cetera. It is imperative that control compartments, burners, and circulating air passageways of the appliance be kept clean.
- Do not use this appliance if any part has been under water. Immediately call a qualified service technician to inspect the appliance and to replace any part of the control system and any gas control that has been under water.

Specifications

Approval & Codes

This appliance is certified to ANSI Z21.88/CSA 2.33 American National Standard / CSA Standard for Vented Gas Fireplace Heaters for use in Canada and USA, and to CGA 2.17-91 High Altitude Standard in Canada. This appliance is for direct vent installations.

This appliance complies with CSA P.4.1-15 Testing method for measuring annual fireplace efficiencies.

The installation must conform to local codes or, in the absence of local codes, with the National Fuel Gas Code, ANSI Z223.1/NFPA 54 or the Natural Gas and Propane Installation Code CAN/CGA-B149.1. Only qualified licensed or trained personnel should install this appliance.

This appliance must be electrically grounded in accordance with local codes, or, in the absence of local codes, with the National Electrical Code, ANSI/NFPA 70 or the Canadian Electrical Code, CSA C22.1.

Ratings

| Model | 739VN | 739VP |
|-----------------------------------|---------------|---------|
| Gas | Natural | Propane |
| Altitude (Ft.)* | 0-4,500 feet* | |
| Input Maximum (Btu/h) | 24,000 | 24,000 |
| Input Minimum (Btu/h) | 13,000 | 13,000 |
| Manifold Pressure (in w.c.) | 3.2 | 10.0 |
| Minimum Supply Pressure (in w.c.) | 5.0 | 11.0 |
| Maximum Supply Pressure (in w.c.) | 10.0 | 14.0 |
| Main Burner Injector Marking | 82-750 | 92-260 |
| Pilot Injector Marking | 51 | 30 |
| Min. Rate By-Pass Screw | 185 | 125 |

*High Altitude Installations

Input ratings are shown in BTU per hour and are certified without deration for elevations up to 4,500 feet (1,370 m) above sea level.

For elevations above 4,500 feet (1,370 m) in USA, installations must be in accordance with the current ANSI Z223.1 and/or local codes having jurisdiction. Heating value of gas in some areas is reduced to compensate for elevation—consult your local gas utility to confirm.

For installations at elevations above 4,500 feet (1,370 m) in Canada, please consult provincial and/or local authorities having jurisdiction.

Supply Gas

Heater engine 739VN is used with natural gas.

Heater engine 739VP is used with propane gas.

The supply pressure must be between the limits shown in the Ratings section.

The supply connection is 3/8" NPT female and located on the left side of the control valve. The gas line entry point is on the bottom left hand side of the fireplace. See "Gas Supply" on page 17 for connection details.

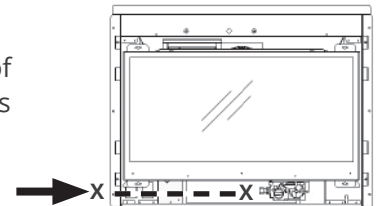

Conversion Kits

The 739V is supplied as natural gas or propane gas and is field convertible between fuels. See instructions packaged with the conversion kits for further information.

Electrical

The 739V is designed to run on battery power and does not require an electrical source to operate as a heater. However, if the appliance is fitted the 755CFK—Circulating Fan Kit, a grounded power source is required.



WARNING

NO ELECTRICAL CONNECTION ALLOWED for any outdoor installation!

Floor/Hearth

This appliance is approved for installation into existing solid-fuel burning fireplaces only. Two screws provided can be used underneath at the back of the appliance, to level it. Or, combustible material such as plywood and so on may be used for leveling and shimming beneath the unit. This appliance does not require a hearth other than to support the weight of certain fronts.

Outdoor Conversion Kit

The 739V models are supplied standard for indoor applications and may be adapted for installation in specific "outdoor" applications protected from weather as defined in the GV60CKO outdoor conversion kit manual.

Kits and Accessories

Required Kits

| Fuel Beds (choose one) | | |
|--|---------------------------|---------|
| 739VDWK | Driftwood Log Set | |
| 739VBLK | Birch Log Set | |
| 739VLSK | Traditional Log Set | |
| Liners (choose one) | | |
| 739RGL | Reflective Glass Panels | |
| 739FBL | Fluted Black Panels | |
| 739VRL | Valor Red Brick Panels | |
| Fronts and Backing Plates (choose one) | Barrier Screen | |
| 741 | Contemporary Steel Fronts | 4003360 |
| 742 | Traditional Cast Front | 4003293 |
| 743 | FenderFire Double Door | w doors |
| 744 | FenderFire Single Door | w door |
| 745 | Clearview Front | 4003313 |
| 765 | Contemporary Surrounds | 4003426 |
| 772 | Matte Black Front | 4004666 |

Above information accurate at the time of printing and subject to change without notice.

Optional Accessories

| Outer Surrounds, Trims & Frets | |
|--|---|
| See your dealer for your choice of Outer Surrounds, Trims & Frets. | |
| Gas Conversion Kits | |
| 739VNGK | Conversion Kit to Natural Gas |
| 739VPGK | Conversion Kit to Propane Gas |
| Other Accessories | |
| 1265WSK | Wall Switch Kit |
| RBWSK | Remote Battery & Wall Switch Kit |
| 755CFK* | Circulating Fan Kit |
| GV60CKO* | Outdoor Fireplace Conversion Kit |
| Hearth Gate | Hearth gates such as Cardinal's VersaGate are available at retail stores carrying safety products for children. |



WARNING

*** NO ELECTRICAL CONNECTION ALLOWED for any outdoor installation!**

Dimensions and Cavity

Fireplace Dimensions

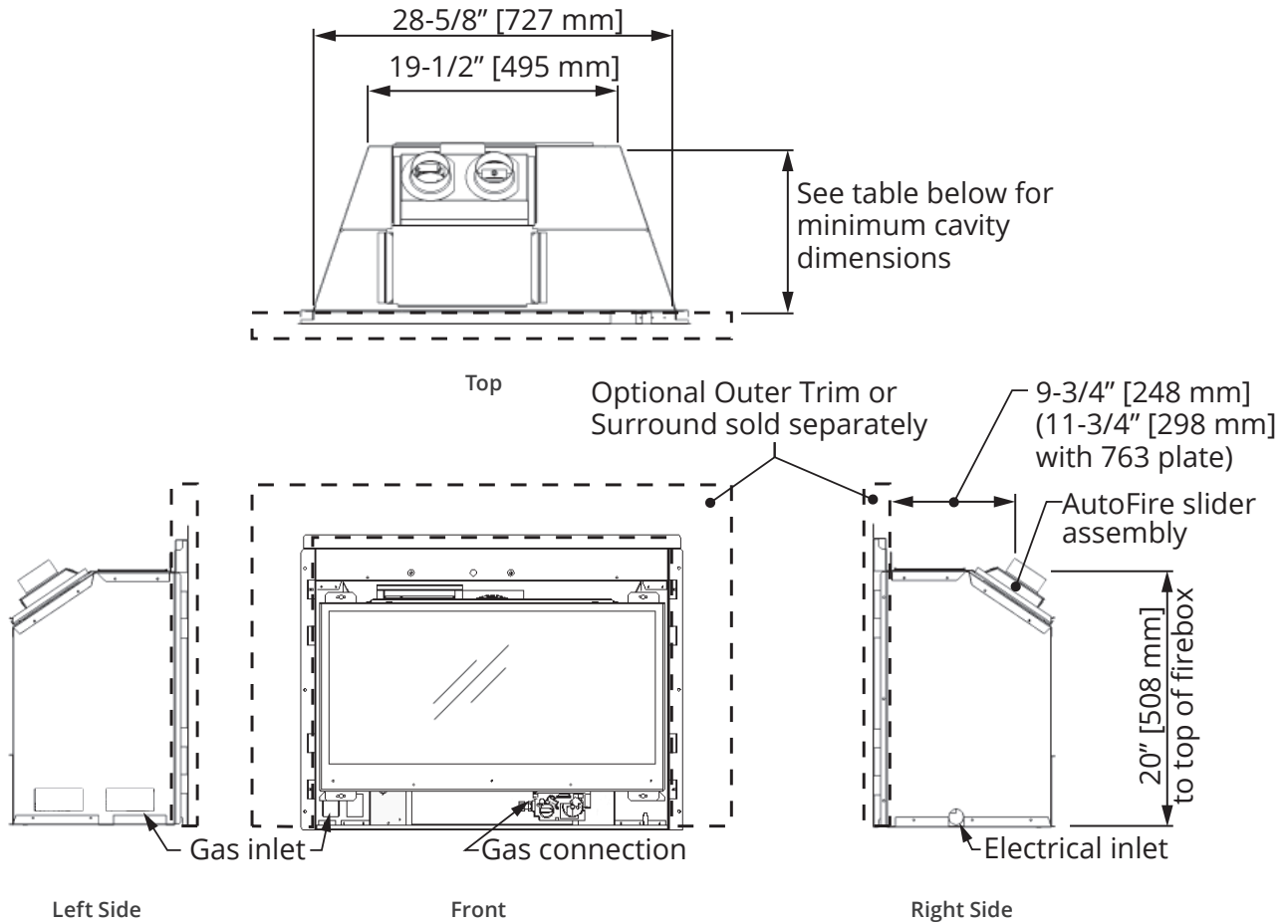

Cavity

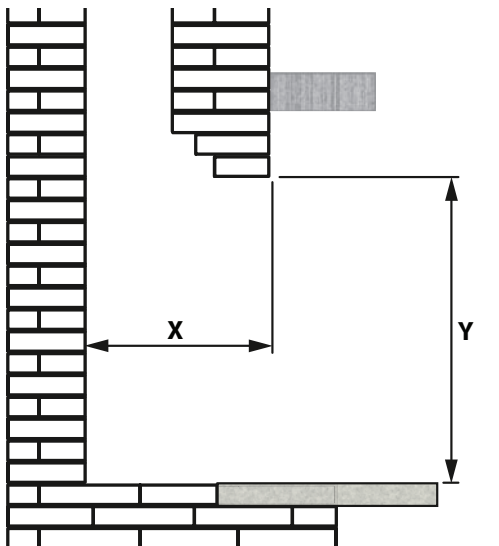

Minimum Cavity Dimensions

Check that masonry step does not interfere with install dimensions or vent pipe.

If mantel is combustible, see the following section for allowable clearances.

| Outer Trims | 746CTK, 748CTK, 756ST, 767STB, 757ST, 715CV, 764PF | 747DTK, 7530TK | 763BPB |
|--------------------|---|---------------------|---------------------|
| Minimum Depth (X) | 12-7/8" [327 mm] | 12-1/4" [312 mm] | 14-3/4" [375 mm] |
| Minimum Height (Y) | 20-1/2" [521 mm] | 20-1/2" [521 mm] | 24" [610 mm] |
| Minimum Width | 28" [711 mm] | 28" [711 mm] | 31" [788 mm] |

Clearances

Combustible Mantel and Sidewall

Combustible Mantel

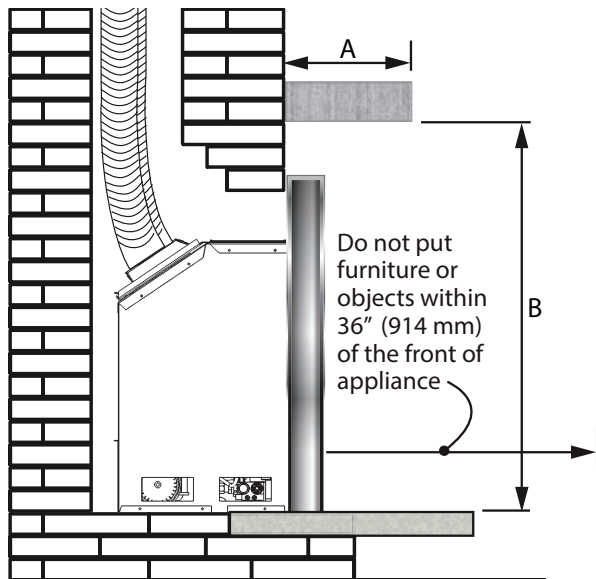

| | | | | |
|---------------------|-------------|-----------------|--------------|--------------|
| Mantel Projection A | 1 [25] | 1-6 [25-152] | 9 [229] | 12 [305] |
| Mantel Height B* | 36 [914] | 39 [991] | 42 [1067] | 45 [1143] |

inches [mm]

*Measure taken from underside of mantel to finished hearth or surface that the unit is sitting on.

Finishing Materials

Combustible Materials: Materials made of or surfaced with wood, compressed paper, plant fibers, plastics, or other material that can ignite and burn, whether flame proofed or not, or plastered or unplastered.

Non-Combustible Materials: Material which will not ignite and burn. Such materials are those consisting entirely of steel, iron, brick, tile, concrete, slate, glass or plasters, or any combination thereof.

Materials that are reported as passing ASTM E 136, Standard Test Method for Behavior of Materials in a Vertical Tube Furnace at 750 °C.

⚠ WARNING

Some materials or items, although safe, may discolor, shrink, warp, crack, peel, and so on because of the heat produced by the fireplace. Avoid placing candles, paintings, photos, and other items sensitive to heat around the fireplace.

Sidewall

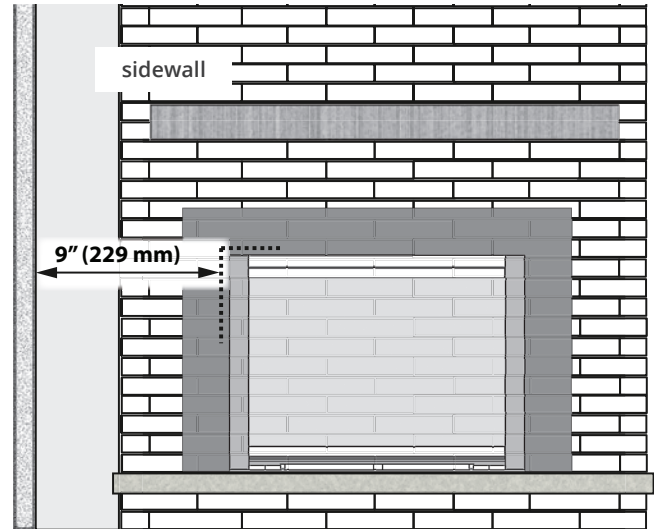

Minimum distance from side of appliance (liner box) to combustible wall: 9" (229 mm).

Mantel legs projecting forward less than 6" (152 mm) may be located within 5" (127 mm) of the side of the appliance (liner box).

Floor/ Hearth Clearances

Combustible shims/supports or provided leveling screws may be used beneath the appliance to level or raise the appliance within the existing fireplace cavity.

Combustible flooring/hearths in front of the appliance are allowed provided they are no higher than the base of the appliance. Carpet, vinyl flooring should be kept back to a minimum of 12" (305 mm) from the front of the insert. The gas insert does not require a hearth.

⚠ WARNING

HOT HEARTH/FLOOR! The hearth or floor in front of the fireplace may become very hot when the fireplace heats. Do not use the hearth as a seat or shelf. Solid wood flooring in front of the fireplace (if allowed) may shrink during the heating season due to heat.

⚠ WARNING

HOT GLASS! The use of a screen in front of the glass is highly recommended, particularly in households with children

Installation Planning

Before Installation



Caution

Only qualified, license, or trained personnel should install this appliance.

Before Installation

1. YOU NEED TO KNOW FROM THE HOMEOWNER:
 - What trim, front, and optional accessories (if any) will be installed with this unit.
2. Unpack the appliance and recycle the packaging.
3. Check that you have everything, using the Pack Content sheet. Also, check that you have:
 - Fuel bed (packed separately)
 - Liner panels (packed separately)
 - Venting accessories
 - Electrical accessories (if using a fan kit)*
 - Any other accessories
4. Carefully read the Installers Checklist included with the fireplace for the installation sequence.



WARNING

**NO ELECTRICAL CONNECTION ALLOWED
for any outdoor installation!**

Installation Planning

Concept

This appliance may **ONLY** be installed in an existing unaltered, functioning solid-fuel burning fireplace with a working flue and constructed of non-combustible material.

This appliance may be installed in outdoor, weather protected environments as defined in the GV60CKO Outdoor Conversion Kit instruction manual.

DO NOT install into combustible construction. This appliance is **NOT APPROVED** for installation with a zero clearance kit.

WARNING

HOT HEARTH / FLOOR! The hearth or floor in front of the fireplace may become very hot when the fireplace heats. Do not use the hearth as a seat or shelf. Solid wood flooring in front of the fireplace (if allowed) may shrink during the heating season due to heat.

WARNING

Some materials or items, although safe, may discolor, shrink, warp, crack, peel, and so on because of the heat produced by the fireplace. Avoid placing candles, paintings, photos, and other items sensitive to heat around the fireplace.

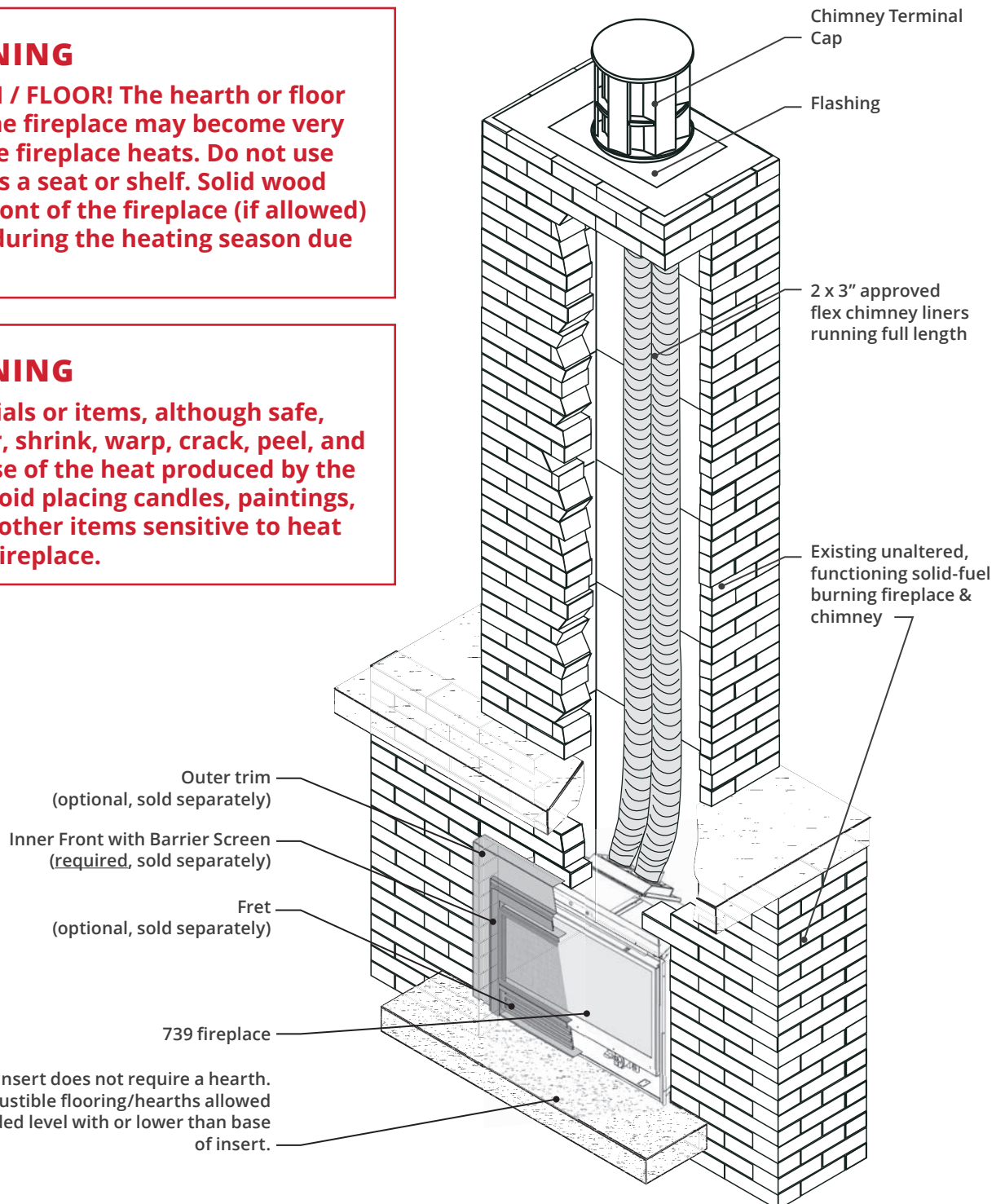

Typical Vent Installation

See "Approved Venting Components" on page 34 of this manual.

Vent Location

The vent terminal must be located through the roof. This direct vent appliance is designed to operate when an undisturbed airflow hits the outside vent terminal from any direction. Check local codes for allowable vertical vent termination.

Venting Table

| | |
|--------------------------------|---|
| Maximum vertical height | 40 ft (measured to bottom of termination) |
| Minimum vertical height | 10 ft (measured to bottom of termination) |
| Maximum horizontal run | 4 ft (measured center to center of pipe) |
| Maximum offset angle | 45° (sweeping bend to allow for obstructions) |

Venting Notes

Where possible, avoid joining flex pipes. If joints are required, use an approved connector and seal joints with RTV high temp sealant.

Horizontal offset is permissible to allow for routing around masonry projections. Avoid bending flex pipe over a 45 degrees radius where possible.

Flex liners may only be installed into solid-fuel burning fireplace and chimney systems (no combustible constructions).

The appliance must not be connected to a chimney flue serving a separate solid-fule burner appliance.

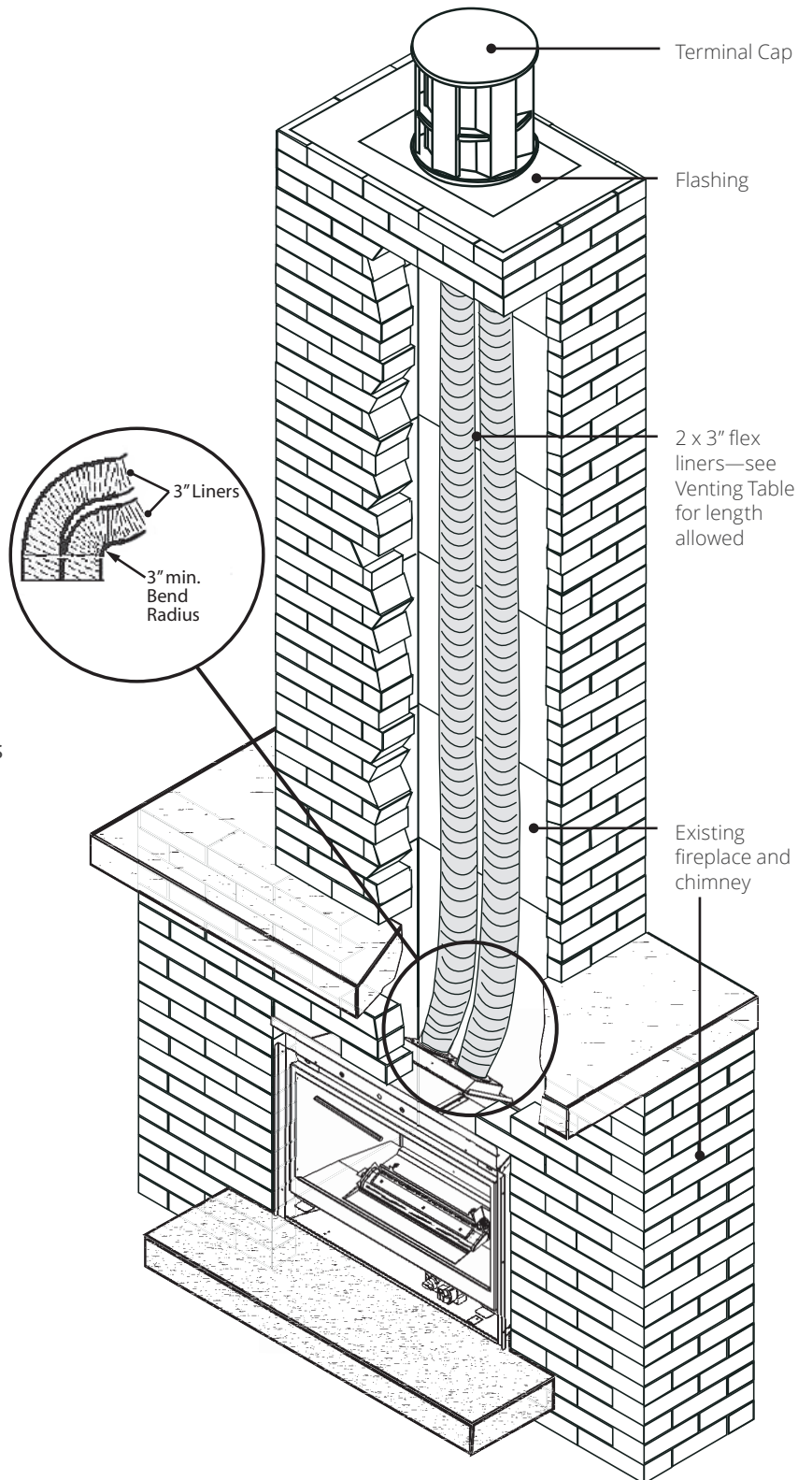

Venting

Concept

Alternate Venting with optional 720SWK-M—Co-linear sidewall kit

The appliance may also be vented using the optional 720SWK-M—Co-linear sidewall kit—see installation instructions supplied with the kit.

NOTE

Depending of the length of the vertical vent run, the AutoFire vent plate may need to be replaced by the vent plate included with the 720SWK-M terminal—see instructions provided with the terminal.

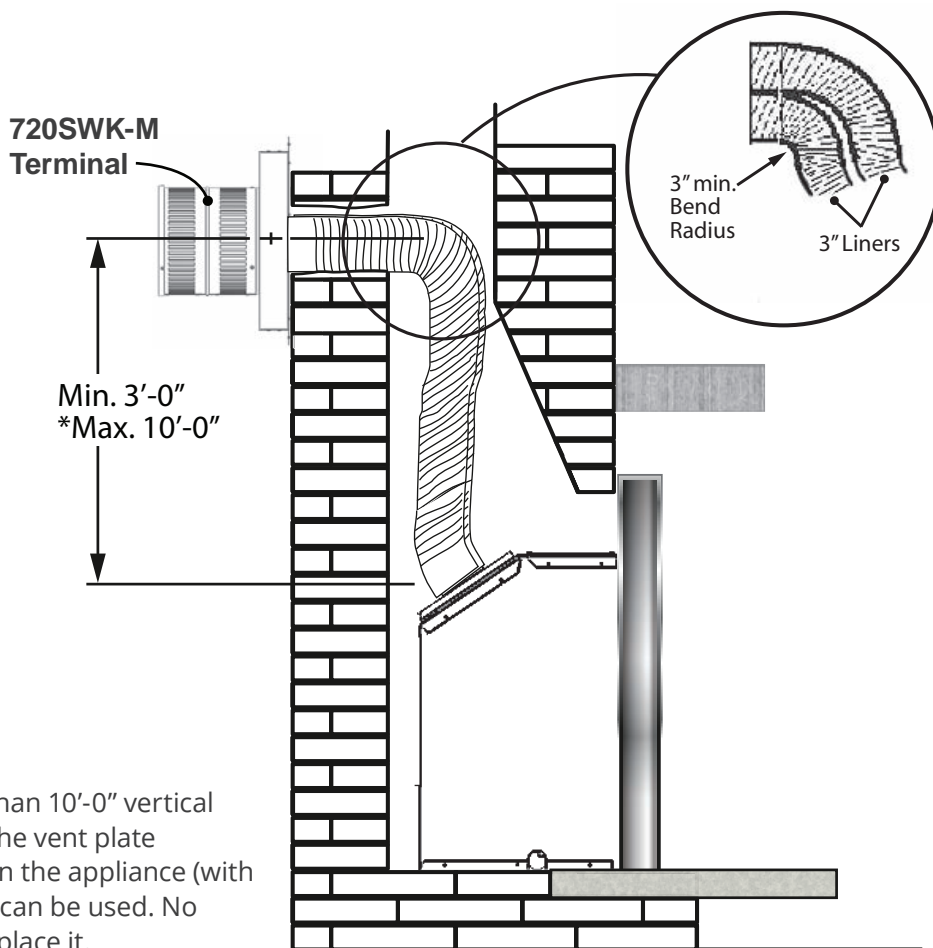

* If more than 10'-0" vertical vent run, the vent plate supplied on the appliance (with restrictor) can be used. No need to replace it.

Preparation

Existing Fireplace

Existing Fireplace Preparation

A few points must be considered before inserting the 739 into an existing fireplace cavity. Generally, no modifications are allowed to the existing fireplace that will compromise the integrity of the existing fireplace.

Components that are bolted or screwed on such as dampers or baffles may be removed to accommodate the installation of the 739 engine.

Cutting away any sheet metal parts of the existing fireplace to accommodate the installation of the 739 is prohibited.

Check with local authorities if in doubt.

Clean Fireplace and Chimney

Have the chimney swept and the fireplace cavity including ash dumps and clean-outs cleaned before installing the 739 heater and vent liners. Any creosote or soot residue remaining in the fireplace cavity chimney or clean-out may cause odors or stains once the 739 insert is installed. Consult with chimney sweep for information on how best to clean.

Existing Dampers

Factory-built, zero-clearance fireplaces will require the damper to be removed in order to install the vent liners. These dampers are usually bolted into place. Dampers in masonry fireplaces must be fixed open and may remain in place.

Ash Retaining Curbs

Some fireplaces (particularly factory-built) have a raised curb at the front edge to retain ashes. Check the dimensions carefully to ensure the 739 engine will fit behind any raised curb (some curbs may be removed separately from the refractory base).

Gas Line Routing

Plan the routing of the gas line before proceeding. Utilize the existing hole for the gas line of the factory-built fireplace.

If the fireplace has no access hole, carefully drill an access hole of 1.5 inch (38 mm) or less through the lower sides or bottom of the firebox. The access hole must be plugged with non-combustible insulation after the gas supply line has been installed.

See *Dimensions* section for detailed location of gas inlet. Also, take into consideration whether or not a fan or shut-off valve will interfere when planning routing of the gas line.

Existing Glass Doors and Wire Screens

Existing glass doors must be permanently removed prior to installing the 739 insert.

Combustible Mantels

Combustible mantel clearances must conform to those required for the original solid-fuel fireplace into which the 739 is being installed.

Attach Warning Conversion Plate to Existing Fireplace

(Label supplied loose with 739 heater)

Attach the "This fireplace has been converted..." label to **the existing fireplace** using screws or other mechanical means and store any removed parts in back of the existing fireplace for future use.

Installation

Window and Fan

Remove Window

The window is held in place by four spring-loaded bolts, two at the top and two at the bottom.

1. To remove the window, turn each bolt a quarter turn to disengage the bolt pin.
2. Gently pull the bottom of the window outward and unhook it from the firebox's top.
3. Set the window aside in a safe place to avoid damage.

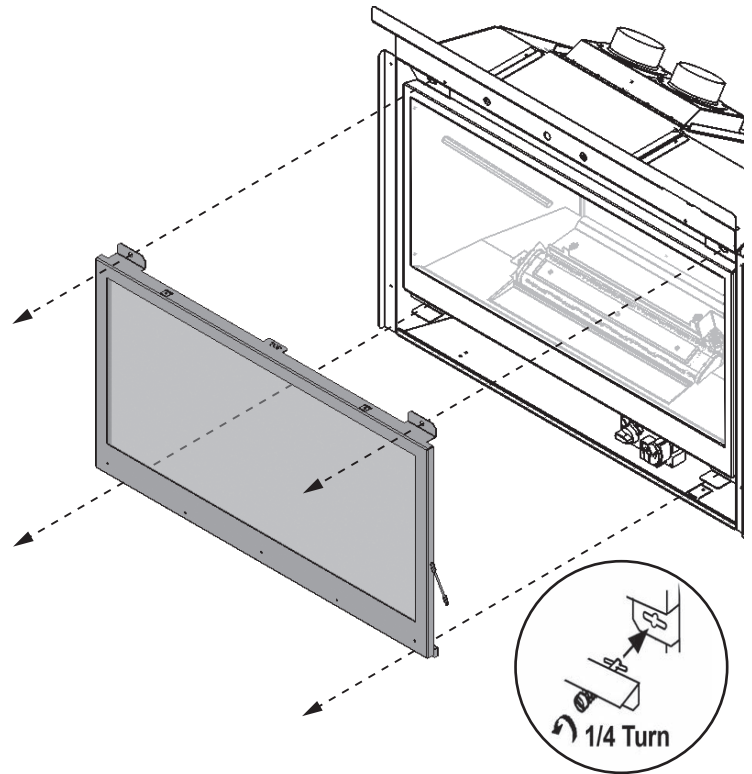

Install Fan (if used)

If the 755CFK—Circulating Fan Kit (blower) is to be installed, we suggest that you do it now.

The fan cavity is accessible from the back of the firebox to facilitate its installation. If the fan is retrofitted after the installation of the appliance, the burner module will need to be removed. Therefore, we recommend that, where possible, the fan be installed before the appliance is fitted into the cavity.

Refer to instructions provided with the 755CFK to install the fan.

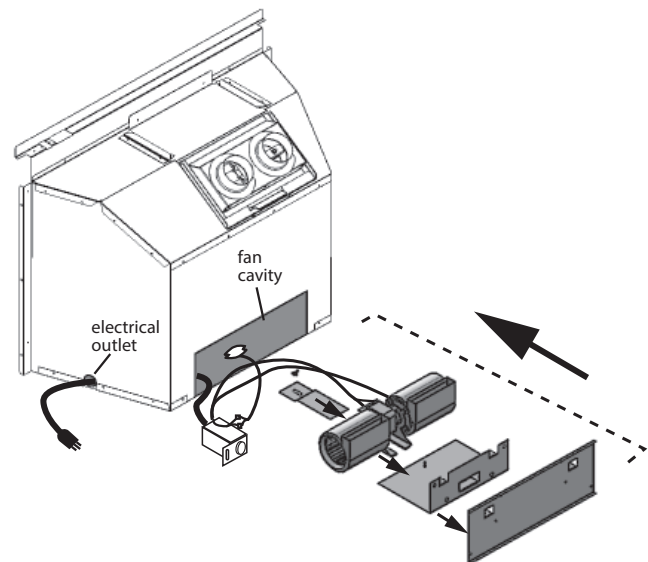

WARNING

**NO ELECTRICAL CONNECTION ALLOWED
for any outdoor installation!**

Installation

Venting System and Appliance

Connect Venting

IMPORTANT: This appliance's venting system is room sealed and therefore, does not require room air to be used in the combustion process.

1. Rough-in two 3" diameter vent liners into the existing chimney system from the roof. Be careful not to tear or damage the liners in the process. It may be easier to install both liners at the same time rather than one at a time. Leave plenty of liners at the bottom to facilitate the connection of the liners to the vent slider. **It is best to leave the top termination until later.** Designate and mark the top and bottom of one liner as "EXHAUST" to avoid confusion later.
2. Release the two screws retaining the vent slider to the front of the firebox. Remove the slider from the firebox by sliding it towards the back of the firebox.
3. Fit the two liners ensuring that the exhaust liner is connected to the identified "EXHAUST" vent collar. Secure liners to collars with hose clamps (included) and 2 tapping screws per liner.
4. Slide the firebox onto the vent slider in the cavity taking care not to damage the liners. **Make sure that the rear edge of the slider is hooked over the cleat on the firebox.** Secure the vent slider to the front of the firebox with two screws removed earlier.
5. From the roof, pull the liners and fit the flashing.
6. Fit the terminal cap ensuring that the exhaust liner is connected to the exhaust vent collar. Secure with screws.
7. Seal the terminal and flashing from water penetration as required.

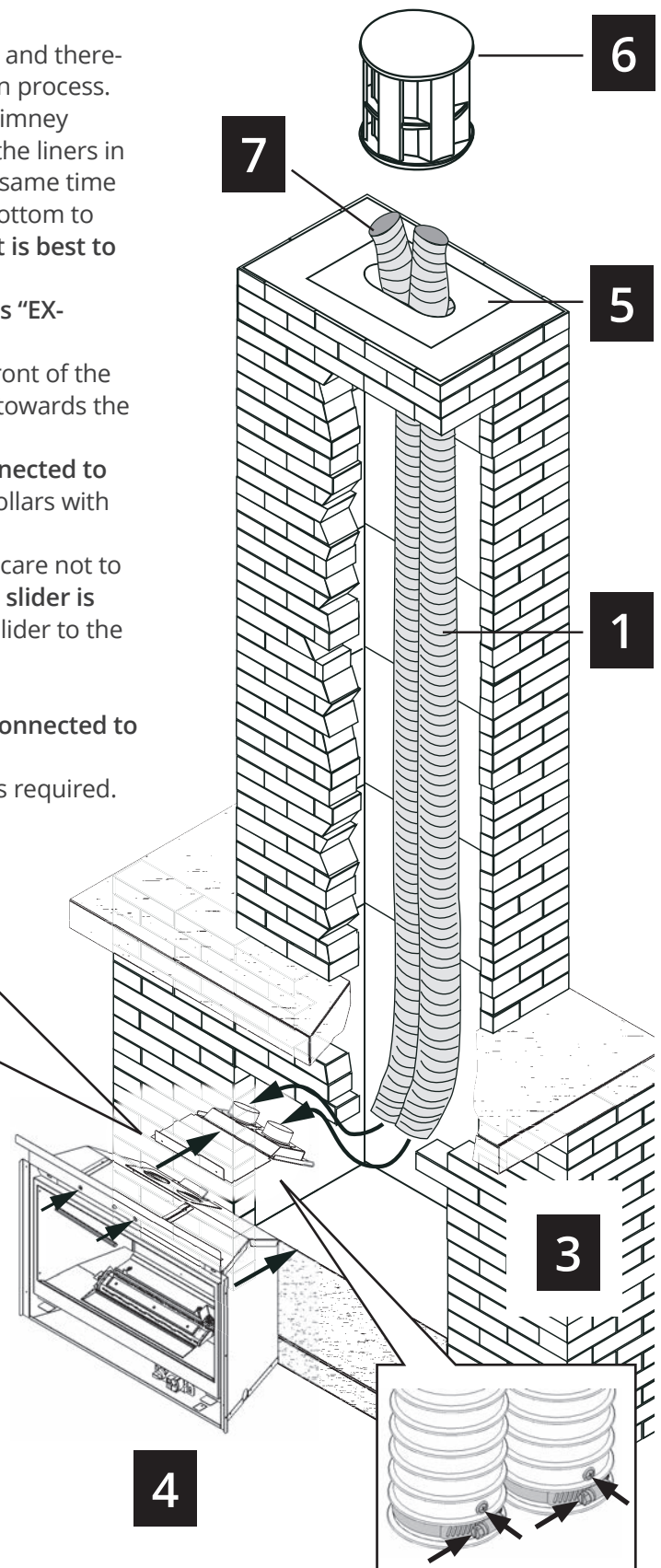
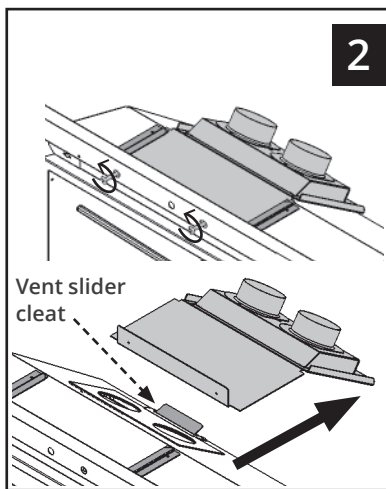

⚠ WARNING

Failure to position the parts in accordance with these diagrams or failure to use only parts specifically approved with this appliance may result in property damage or personal injury.

Installation

Gas Supply

Connect Gas Supply

The gas supply inlet connection is a 3/8" NPT female connector and is located on the left hand side of the control valve.

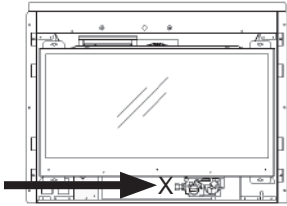

Use only new black iron or steel pipes, CSST, or copper tubing if acceptable—check local codes. Note that in USA, copper tubing must be internally tinned for protection against sulfur compounds.

The burner module and gas train on this appliance may be removed as a unit for servicing. The flex pipe supplied with the unit provides a union for removal of the module.

Unions in gas lines should be of ground joint type.

The gas supply line must be sized and installed to provide a supply of gas sufficient to meet the maximum demand of the appliance without undue loss of pressure.

Sealant used must be resistant to the action of all gas constituents including LP gas. Sealant should be applied lightly to male threads to ensure excess sealant does not enter gas lines.

Pressure test the supply line for leaks.

The appliance and its individual shut-off valve must be disconnected from the gas supply piping system during any pressure testing of that system at test pressures in excess of 1/2 psig (3.5 kPa).

The appliance must be isolated from the gas supply piping system by closing its equipment shut-off valve during any pressure testing of the gas supply piping system at test pressures equal to or less than 1/2 psi (3.5 kPa).

Failure to either disconnect or isolate the appliance during pressure testing may result in regulator or valve damages and void the warranty. Consult your dealer in case of damages.

Pressure Test Points

The minimum supply pressure is given in the section "Specifications" on page 6 of this manual.

All piping and connections must be tested for leaks after installation or servicing. All leaks must be corrected immediately.

When testing for leaks:

- Make sure that the appliance is turned off.
- Open the manual shut-off valve.
- Test for leaks by applying a liquid detergent or soap solution to all joints. Bubbles forming indicate a gas leak.



WARNING

NEVER USE an open flame to check for leaks. Correct any leak detected immediately.

The pressure test tapping locations are shown in the figure below. An internal regulator within the valve controls the burner manifold pressure.

The correct pressure range is shown in the table in section "Specifications" on page 6. The pressure check should be made with the burner alight and at its highest setting. See "Appendix A - Lighting Instructions Plate" on page 36 for full lighting details.

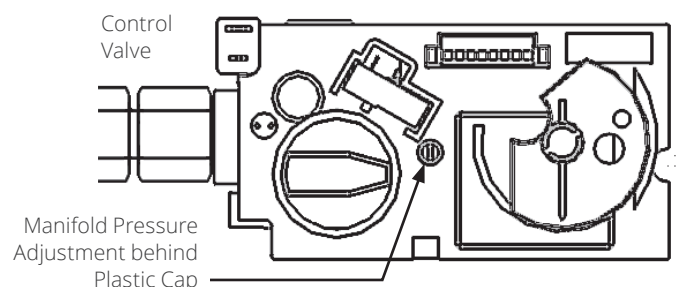
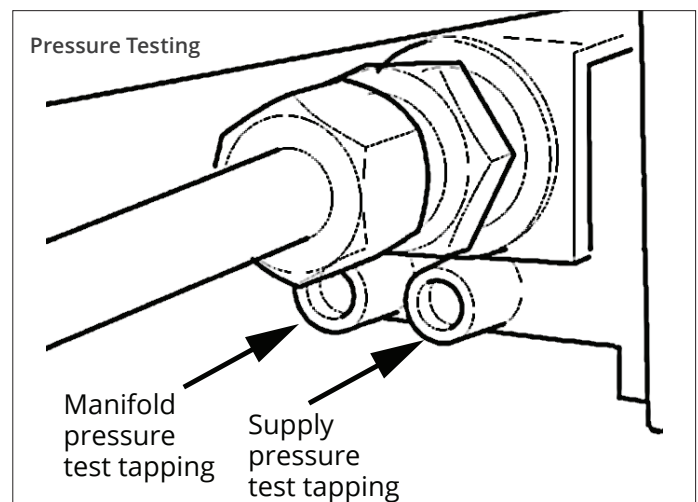

Installation

Liner Panels

Install Liners

The following guidelines apply for all liners (with the exception of the 739RGL Reflective Glass Liners—see the installation manual supplied with that liner kit for details).

1. Inside the firebox, on the top of each side, release the screw of the side brick anchors (one per side) just enough to allow them to rotate.



2. Remove the fuel bed support (2 screws).

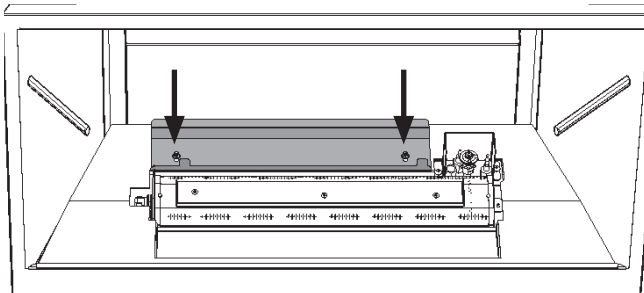

3. Remove the burner cover (2 screws).

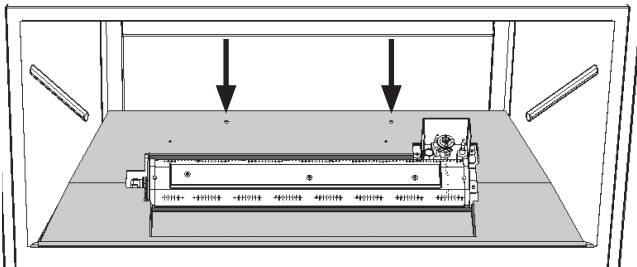

4. Rotate the anchor up and out of the way and slide the left hand side panel against the firebox side. The panel should be parallel to the edge of the burner plate. Slide the panel forward. Rotate the anchor back down to hold the panel.

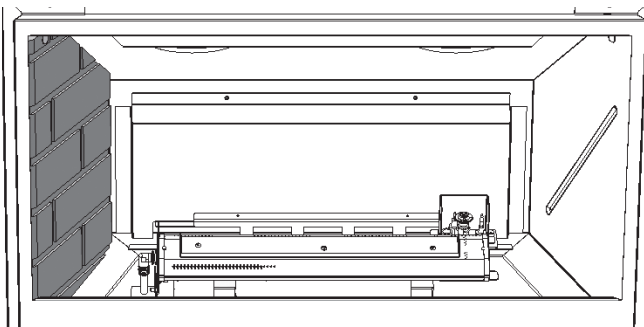

5. Place the rear panel against the back of the firebox resting it on the ledge at bottom. Two tabs are holding it. Slide it behind the left side panel to hold it.

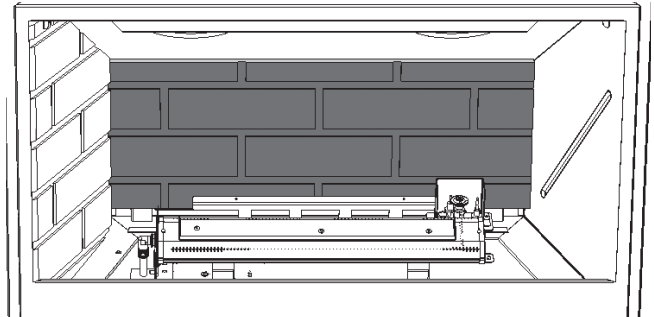

6. Rotate the anchor up and out of the way and slide the right hand side panel against the firebox side. The panel should be parallel to the edge of the burner plate. Rotate the anchor back down to hold the panel.

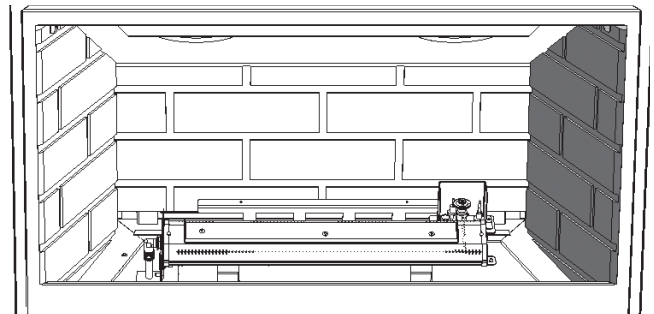

7. Tighten the side brick anchors on each side of the firebox.



8. Reinstall the burner cover being careful not to scratch the brick while inserting it into the firebox. Secure it (2 screws).

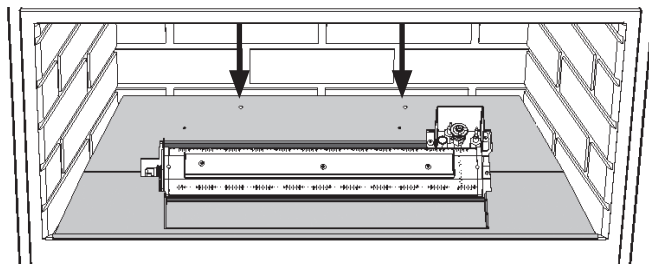

Installation

Liner Panels

9. Reinstall the fuel bed support without tightening the screws yet; slide it as far back as possible and then, tighten the two screws.

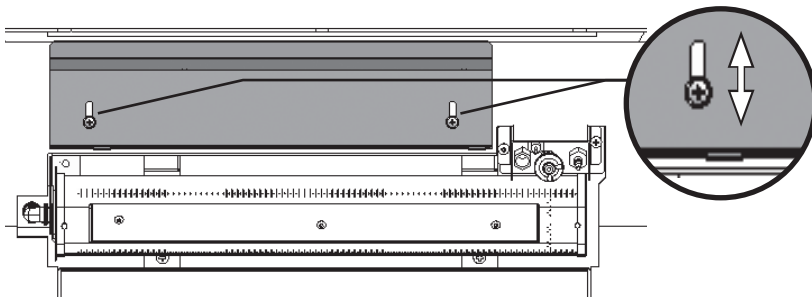
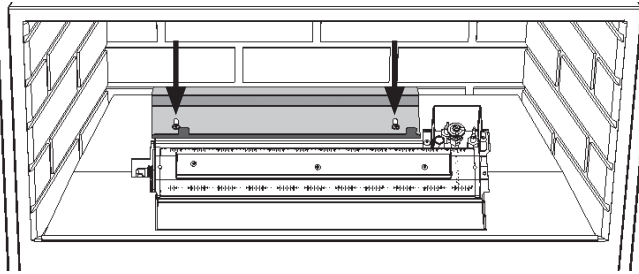

Generally, the fuel bed support, as installed above, will generate the best flame for any of the log sets. However, its position can be adjusted in certain circumstances.

Moving the log support forward will allow more impingement/glow/flame height; moving the log support backward will do the opposite.

Installation

Fuel Beds

Birch Log Kit 739VBLK

Material required

- Birch Log Kit, which contains:
 - 7 logs
 - 3 ember chunks
 - 1 2-cup bag of embers
- Gloves, if desired, non included

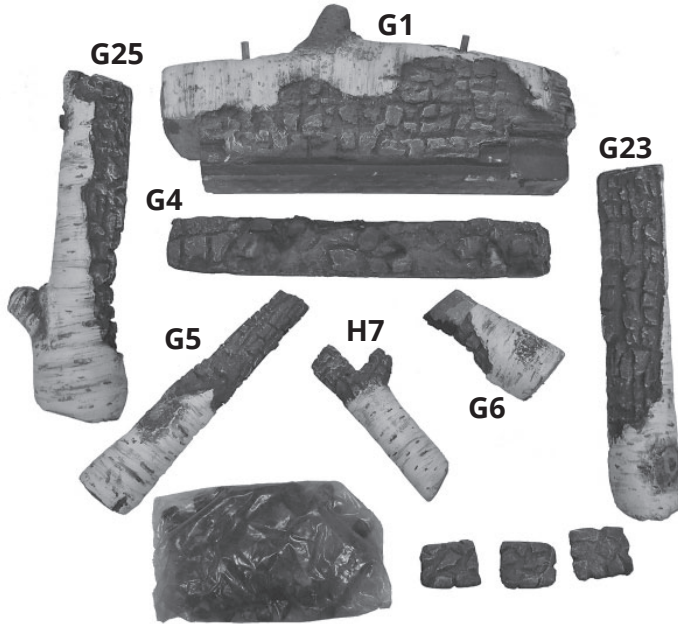

Installation

Carefully unpack the kit. Note each log has its own number stamped on the bottom. Some logs have pegs to help place them.

1. Place G4 ember bed onto the burner, placing the groove under the log on the burner's front top rail as indicated.

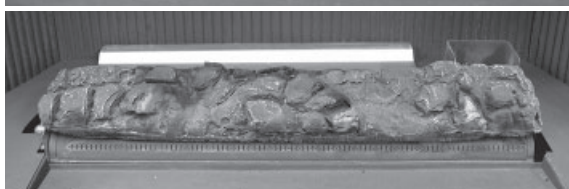
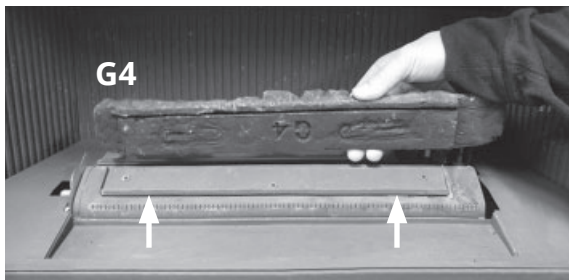

Log G4 installed

2. Place log G1 behind the burner on the fuel bed support and slide it forward until it touches the front vertical tabs of the support. Slide the log to the right so it rests against the pilot shield.

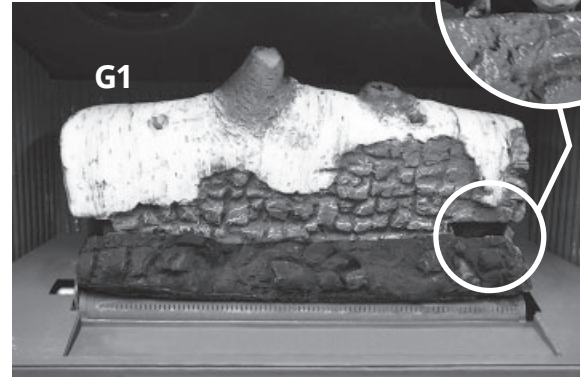

3. Place embers, by hand, in the cavity in front of the burner as indicated.



4. Place log G25 on the left pin of G1 resting the other end on the burner cover left side of the embers.

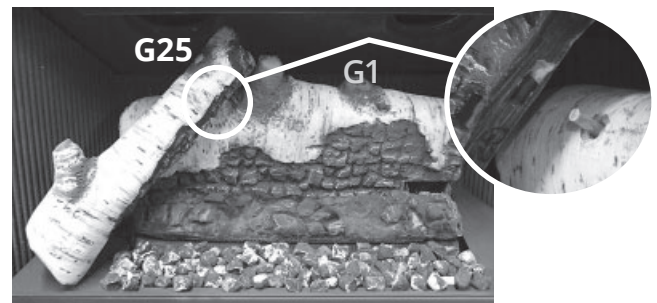

5. Place log G23 on the right pin of G1 resting the other end on the burner cover right of the embers.

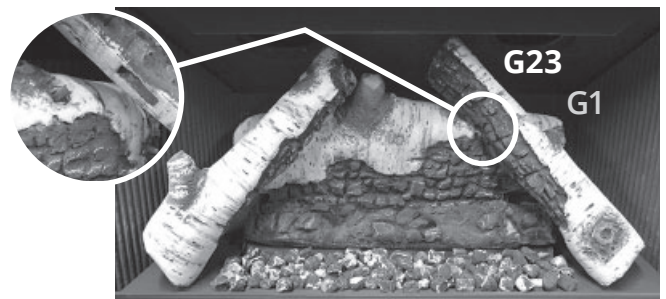

Installation

Fuel Beds

- Place the burned end of log G6 on top of the ember bed and rests its other end on the embers as indicated. Ensure the notch on the log is on top.

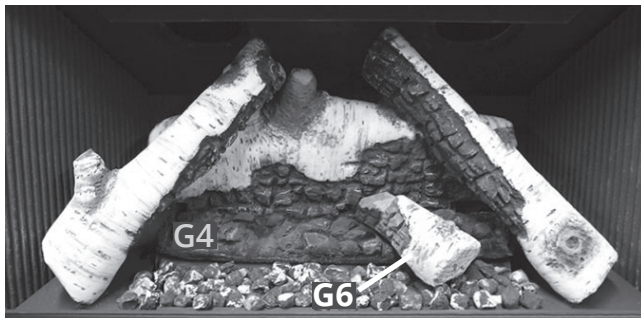
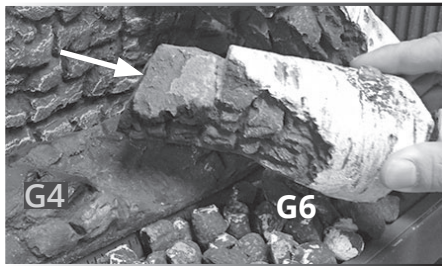

Log G6 installed

- Place the burned end of log G5 on the notch of G6 and rests its other end on the embers.

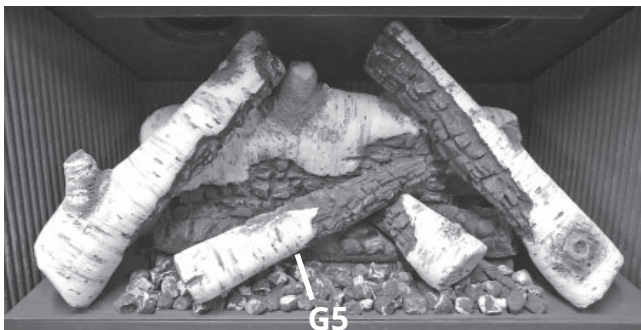
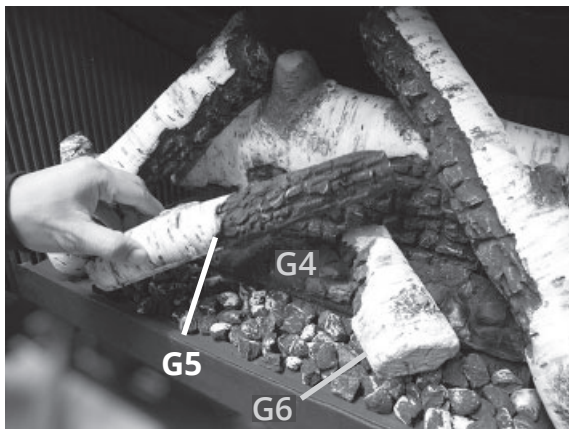

Log G5 installed

- Place log H7 resting its light part on G5 and its forked end on the ember bed G4 under log G25. The short end of the fork should be near the rear log G1.

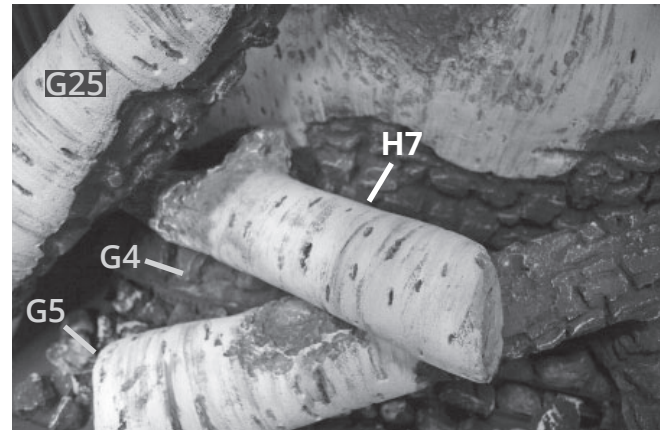

Log H7 installed

Installation

Fuel Beds

- Place ember chunks on the ember bed between the logs.



Ember chunks installed

IMPORTANT

Approved for use only with the ceramic embers provided with your Valor fireplace. The use of any other products may void your fireplace warranty.

WARNING

Choking Hazard! Ensure that the fireplace area is clear of embers as these could be ingested by small children. Vacuum area after installation.

739VBLK installed

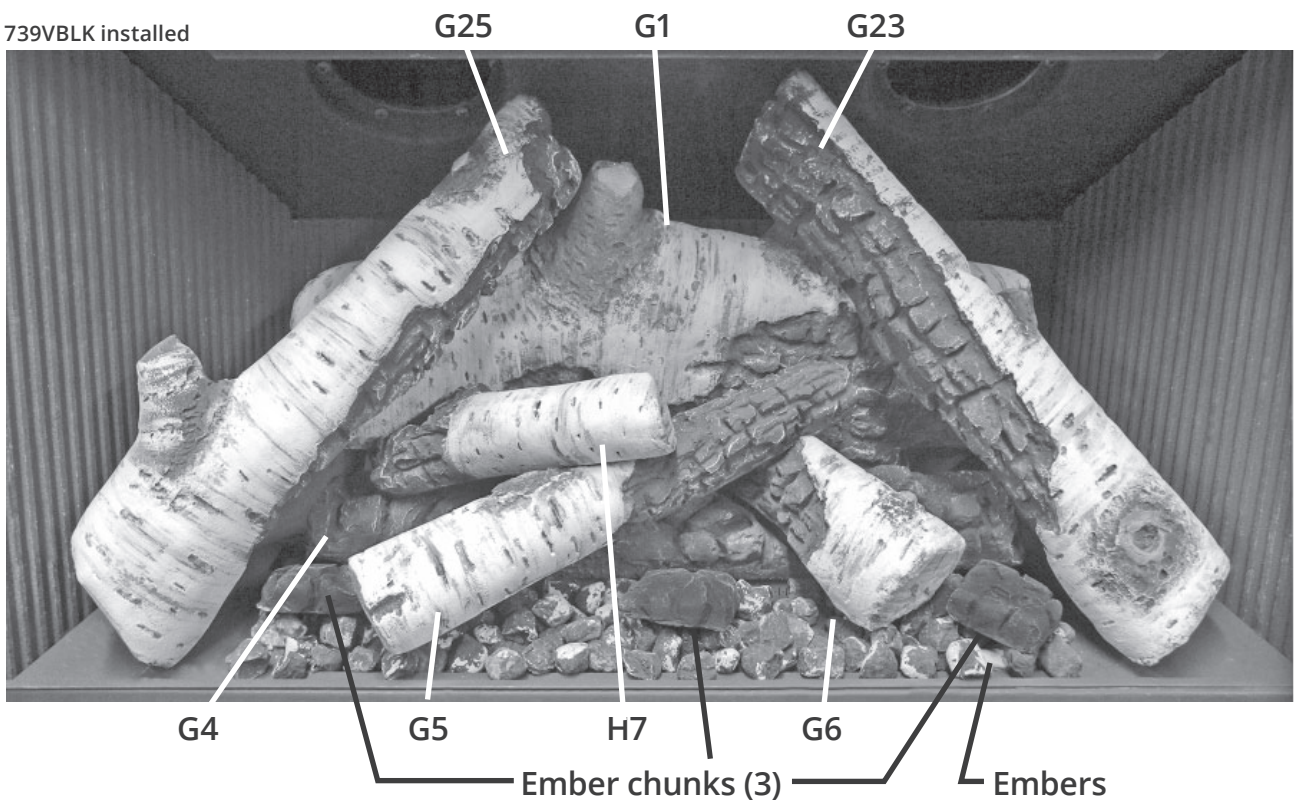

Installation

Fuel Beds

Driftwood Kit 739VDWK

Material required

- Driftwood Log Kit, which contains:
 - 7 logs
 - 3 pebbles
 - 1 2-cup bag of embers
- Gloves, if desired

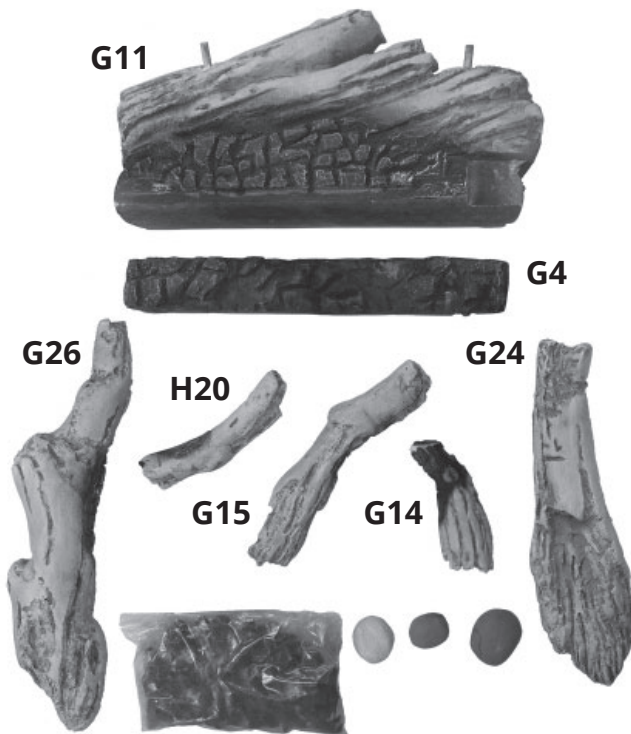

Installation

Carefully unpack the kit. Note that each log has its own number stamped on the bottom. Some logs have pegs to help place them.

Install the logs as shown below.

1. Install G4 ember bed onto the burner, placing the groove under the log on the burner's front top rail as indicated.

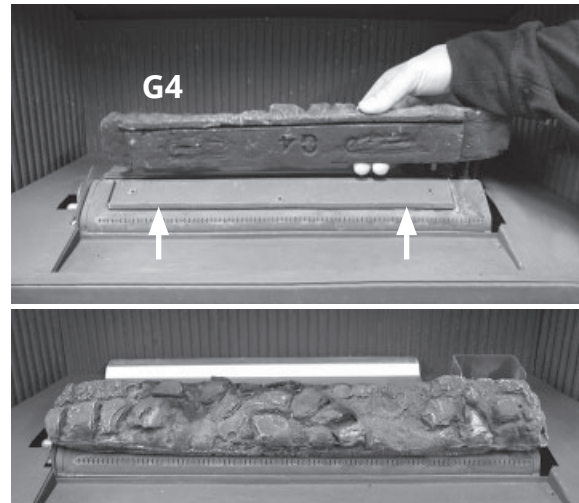

Ember bed G4 installed

2. Place embers, by hand, in the cavity in front of the burner as indicated.

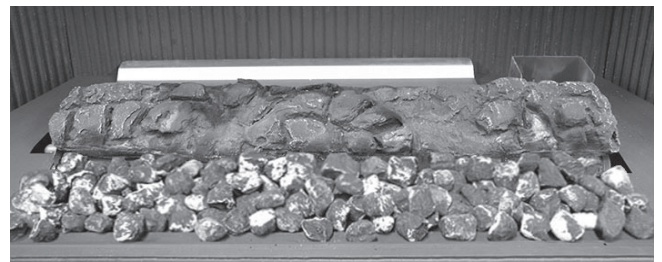

3. Place log G11 behind the burner on the fuel bed support and slide it forward until it touches the front vertical tabs of the support. Slide the log to the right so it rests against the pilot shield.

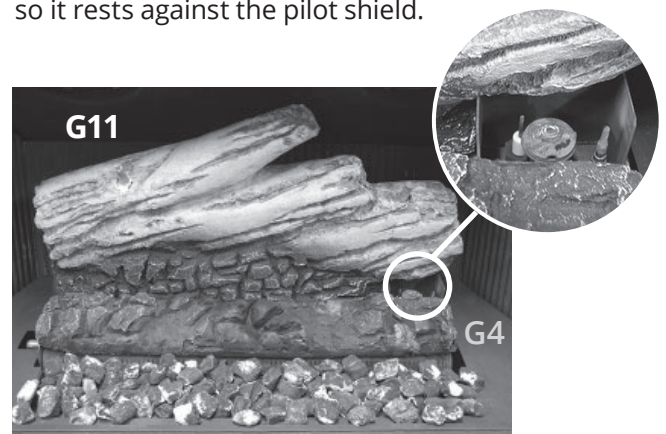

Installation

Fuel Beds

4. Install G26 placing it over the left pin on G11 and resting its other end left of the embers' cavity.

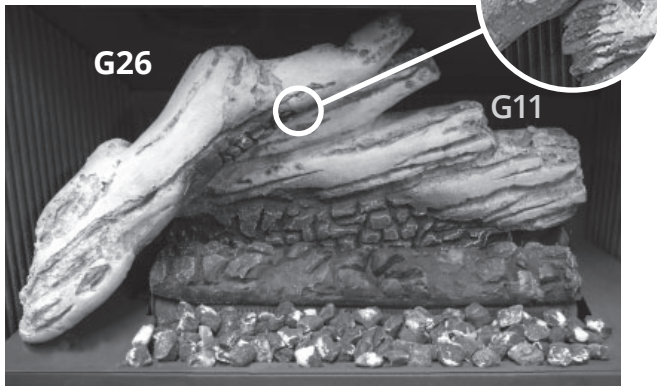

7. Place G15 on the notch of G14 and rest its other end on the embers.



5. Install G24 placing it over the right pin on G11 and resting its other end right of the embers' cavity.

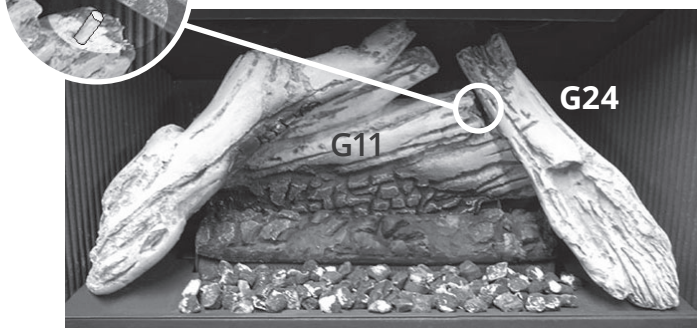

Logs G14 and G15 installed

6. Place G14 burned end in the flatter area on G4 ember bed and the other end on embers, ensuring the notch on G14 is at the top.



8. Place H20 on top of G15 and rest its other end on G4 ember bed under G26.

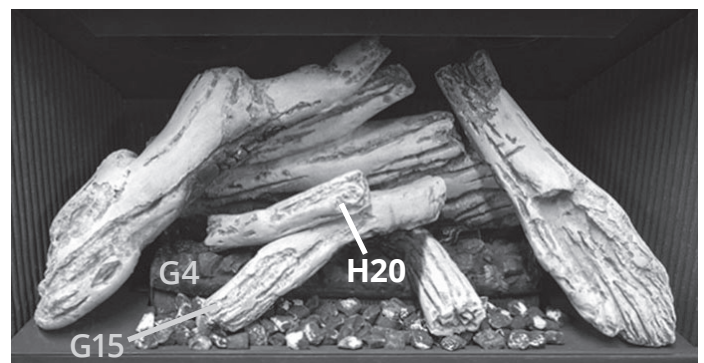

Installation

Fuel Beds

- Place ceramic pebbles on the embers between the logs as shown.

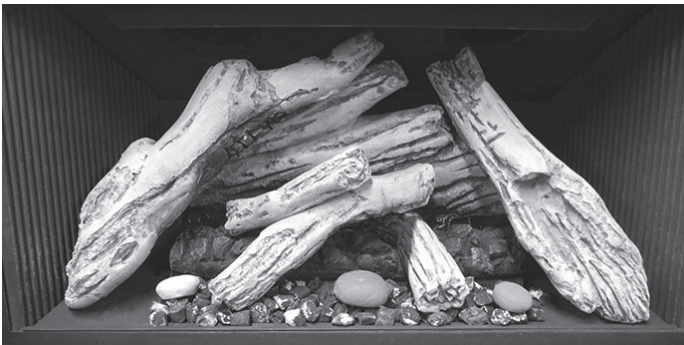

Pebbles installed

IMPORTANT

Approved for use only with the ceramic embers provided with your Valor fireplace. The use of any other products may void your fireplace warranty.

WARNING

Choking Hazard! Ensure that the fireplace area is clear of embers as these could be ingested by small children. Vacuum area after installation.

739VDWK installed

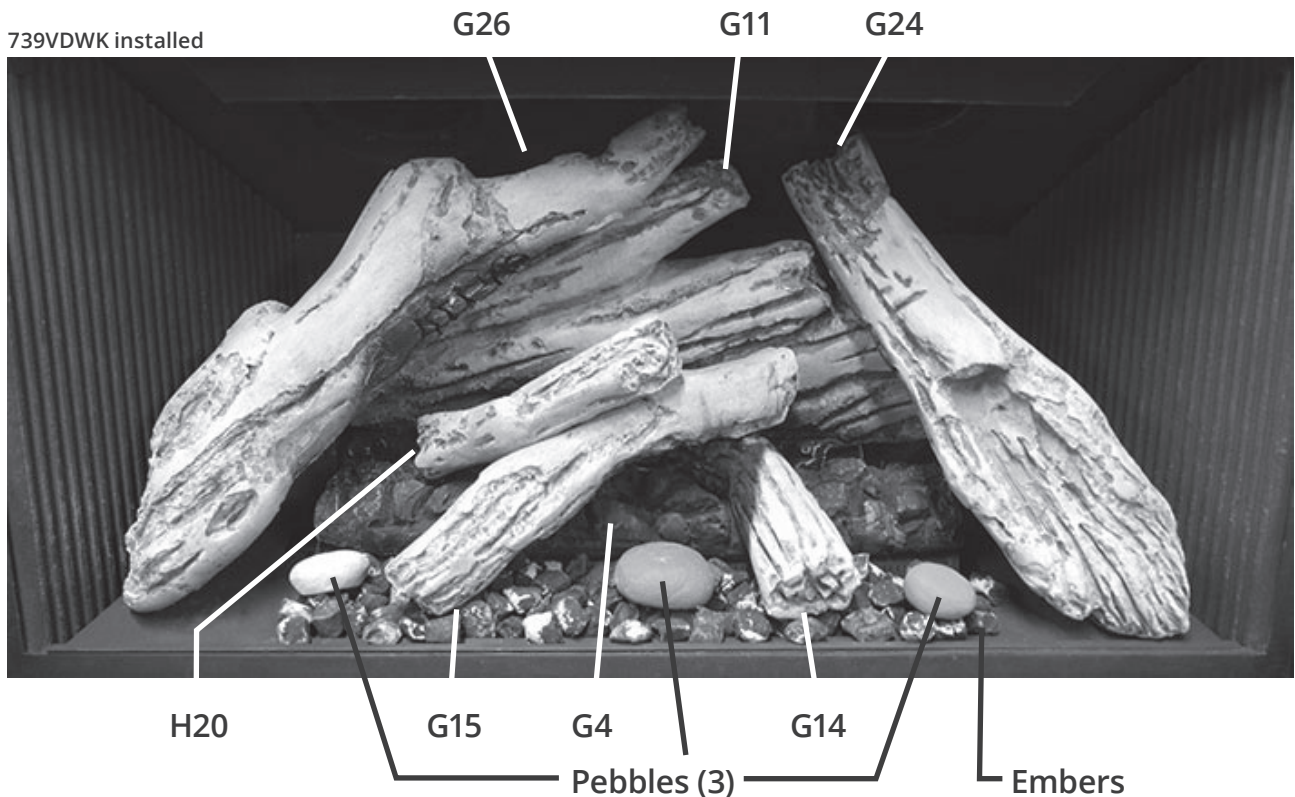

Installation

Fuel Beds

Traditional Log Kit 739VLSK

Material required

- Traditional Log Kit, which contains:
 - 7 logs
 - 3 ember chunks
 - 1 2-cup bag of embers
- Gloves, if desired, not included



Installation

Carefully unpack the kit. Note each log has its own number stamped on the bottom. Some logs have pegs to help place them.

1. Install G4 ember bed onto the burner, placing the groove under the log on the burner's front top rail as indicated.

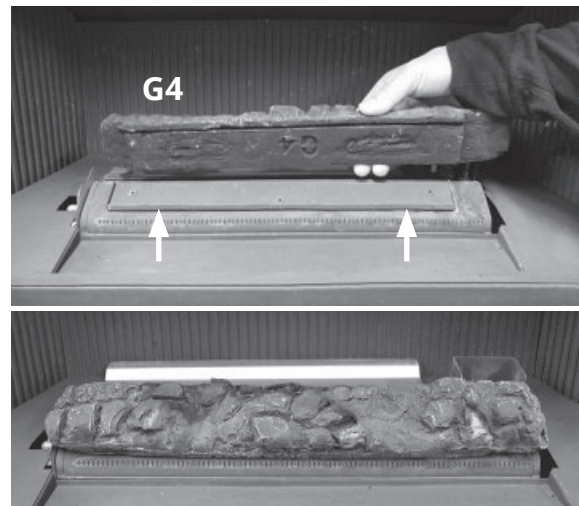

Ember bed G4 installed

2. Place embers, by hand, in the cavity in front of the burner as indicated.

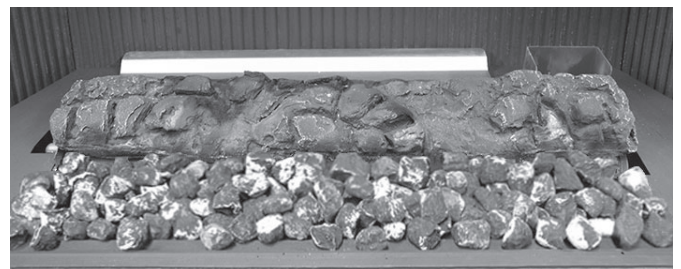

3. Place log G21 behind the burner on the fuel bed support and slide it forward until it touches the front vertical tabs of the support. Slide the log to the right so it rests against the pilot shield.

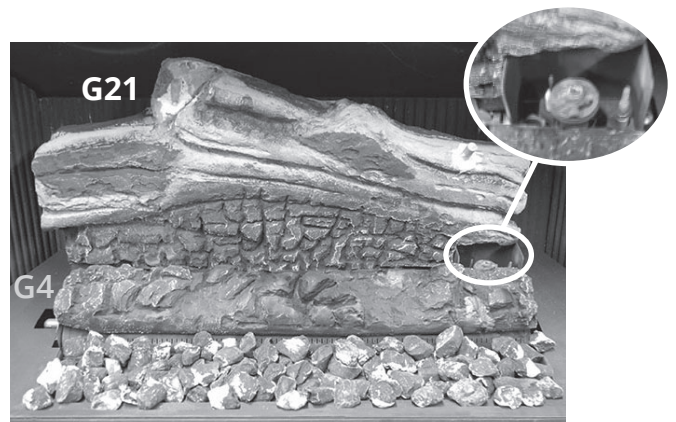

Installation

Fuel Beds

4. Install G20 placing it over the left pin on G21 and resting its other end left of the embers' cavity.

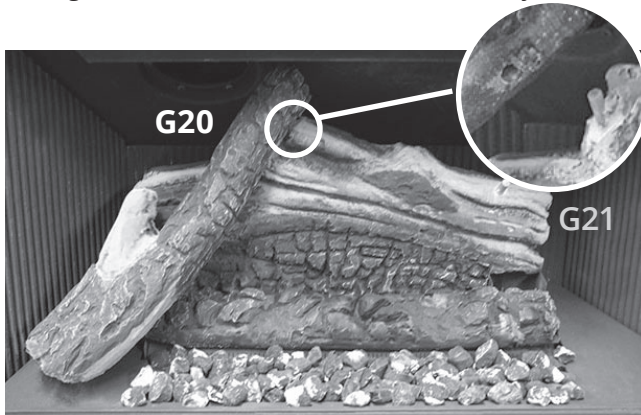

5. Install G9 placing it over the right pin on G21 and resting its other end right of the embers' cavity.

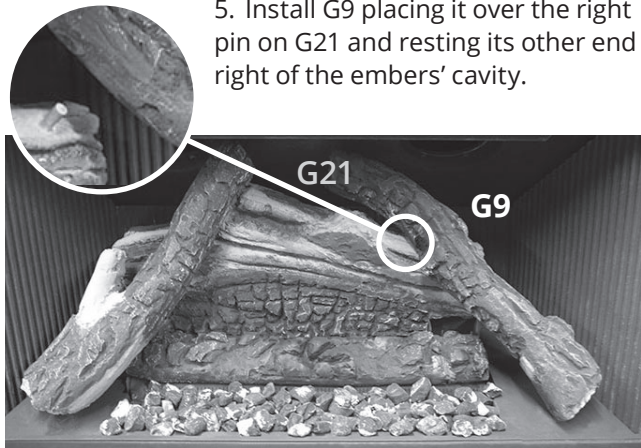

6. Place G10's burned end in the flatter area on G4 ember bed and the other end on embers, ensuring the notch on G10 is at the top.

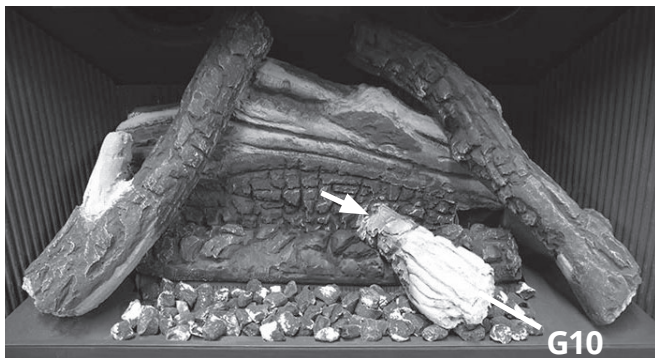
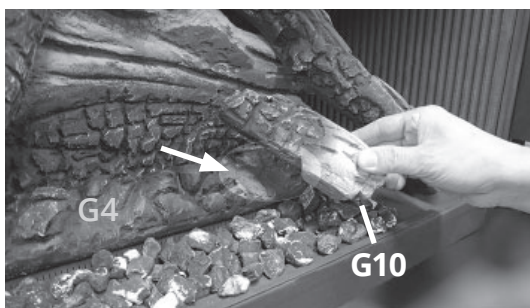

Log G10 installed

7. Place G16 on the notch of G10 and rest its other end on the embers.



8. Insert H28, fork short end down, behind G20 and rest it on G4 ember bed; rest its light end on G16.

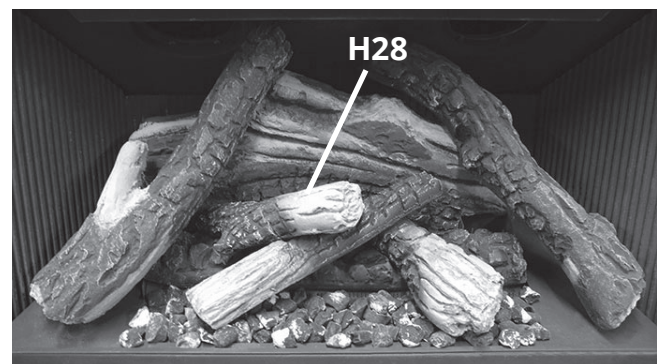
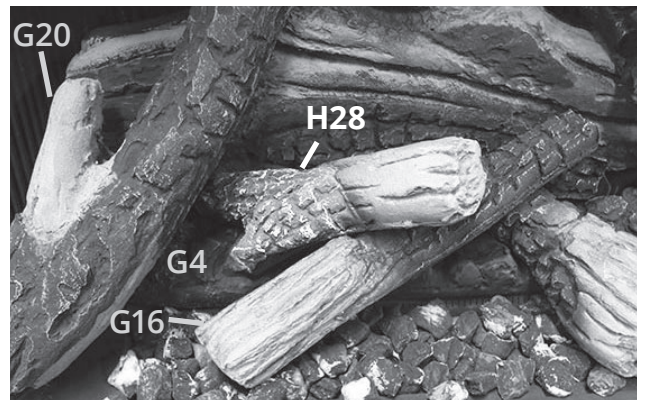

Log H28 installed

Installation

Fuel Beds

- Place ceramic ember chunks on the embers between the logs as shown.



Ember chunks installed

IMPORTANT

Approved for use only with the ceramic embers provided with your Valor fireplace. The use of any other products may void your fireplace warranty.

WARNING

Choking Hazard! Ensure that the fireplace area is clear of embers as these could be ingested by small children. Vacuum area after installation.

739VLSK installed

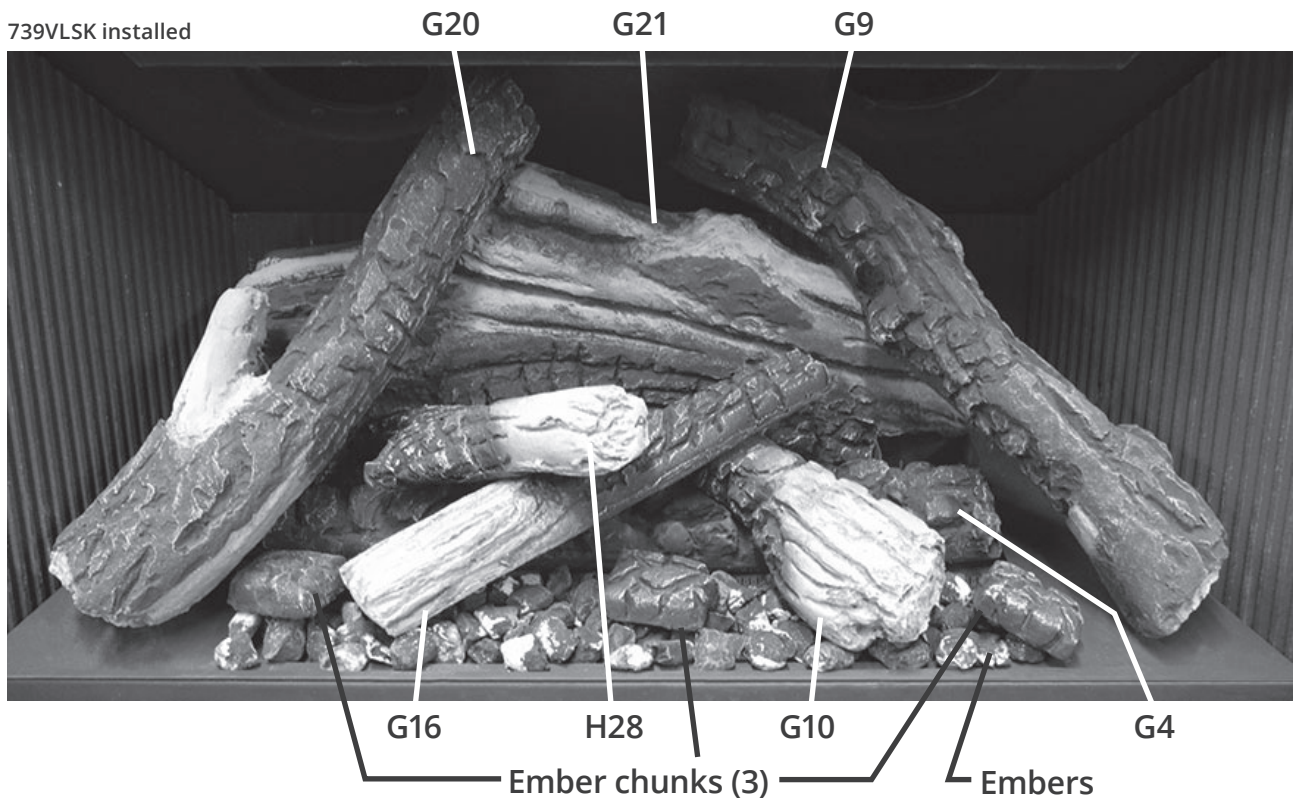

Installation

Window Re-Installation and Verification

Refit and Check Window

1. To refit the window, place the window against the firebox's opening frame. Ensure that the wider part of the window frame is at the bottom. The top is marked TOP.

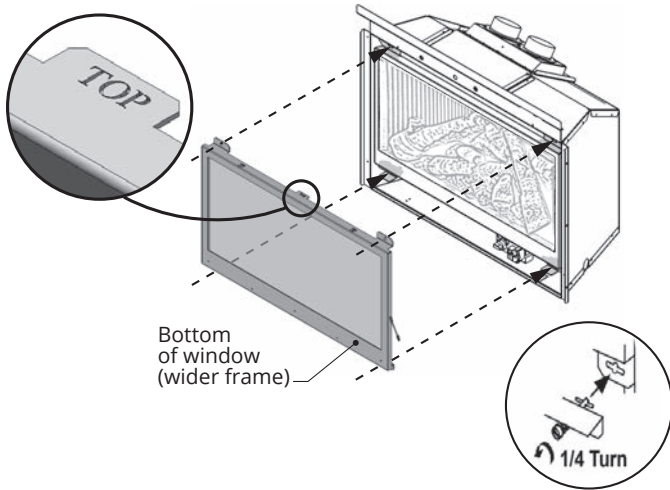

1. While you hold the window, push in and turn the two bottom spring-loaded bolts a quarter turn to engage their pin into the firebox's tabs.
2. Push the top of the window against the firebox and fasten the two top spring-loaded bolts a quarter turn.
3. Pull out and release the top and bottom of the window and release it to ensure the springs return it.
4. Apply firm hand pressure around the window frame to ensure it is sealed tight against the firebox.
5. If the Hot Glass Warning plate has been removed from the front lower corner of the window, reinstall it by sliding it between the glass and the frame as indicated below.

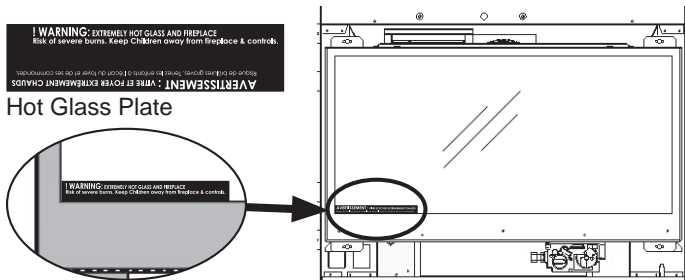

! WARNING

The window unit must be correctly installed, fastened and sealed after servicing or serious bodily injury and/or damage to the appliance may result.

To ensure a safe operation:

- Double-check that the bottom of the window frame is correctly installed on the bottom support tabs;
- Verify that the bolts are hooked properly to the window tabs then;
- Pull out and release the top and bottom of the window to insure the springs return it;
- Ensure the window is sealed before operation.

! WARNING

Failure to install the window correctly can:

- Leak carbon monoxide.
- Affect the performance of the fireplace.
- Damage components.
- Cause overheating resulting in dangerous conditions.

Damage caused by incorrect window installation is not covered by the Valor Warranty.

Installation

Install Battery Holder

The batteries that power the receiver need to be installed and placed prior to synchronization and use.

1. Take the receiver from under the firebox.
2. The battery holder and cable are supplied with the appliance. Insert 4 x 1.5V high quality alkaline batteries in the battery holder and 1 x 9V battery in the remote handset.



3. Connect the cable to the receiver.
4. Connect the other end of the cable to the battery holder.

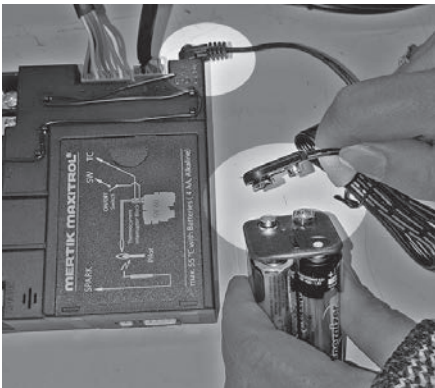

5. Place the receiver and battery holder as shown under the firebox, to the right of the control valve (placement may vary with installed options).

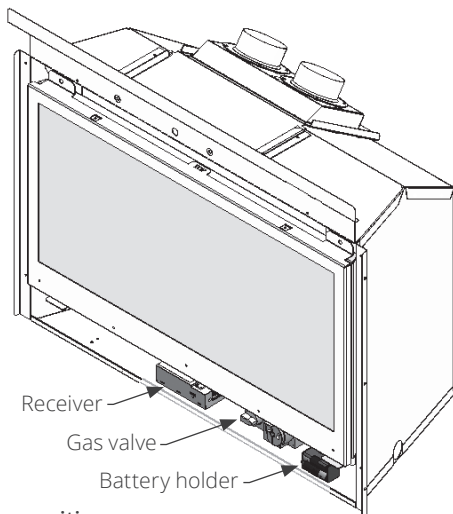

Battery holder position

Batteries and Remote Control

6. Use a heat resistant tie to gather any extra cable between the receiver and the battery holder.

Caution

DO NOT let the cable touch the underside of the burner plate above, it will melt during operation.

Pair Remote Control Receiver and Handset

The receiver and handset of the remote control system must be initially paired before first use.

1. Locate the RESET button on the front face of the receiver.



2. With a thin object, press and hold the receiver's reset button until you hear one short and one long beep. Release the button after the second beep.
3. Within the subsequent 20 seconds, press the small flame button  on the remote handset until you hear two short beeps confirming the pairing is set.

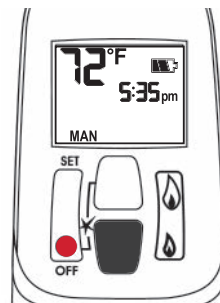

This is a one-time setting only and is not required when changing the batteries in the remote handset. The remote control system is now ready to use.

Installation

Operation and Aeration Verification

Check Operation

Turn the fireplace flame up and down using the remote control to confirm that the full range of inputs is achieved—see “Appendix B - Remote Control Operation” on page 37.

Adjust Aeration (if necessary)

Light the fire and allow the unit to warm up for 10–15 minutes to evaluate the flame picture. Burners are equipped with an adjustable shutter to control primary aeration. See the figures below. The shutters are factory-set to an aeration gap which will give optimum performance for the vast majority of installations.

Depending of fuel bed used, altitude and other considerations, the flame picture may be improved by adjusting the aeration. The need for adjustment should be determined only by operating the appliance with the fuel bed, liners and window installed and evaluating the flame picture after a 15-minute warm-up.

Increasing aeration (opening air shutter) will cause the flames to appear more transparent and blue showing more ceramic effects glow.

Decreasing aeration (closing air shutter) will cause the flames to appear more yellow or orange showing less ceramic effects glow.

Too little aeration may result in black carbon forming and dropping into the firebox.

Air Shutter

The air shutter adjustment lever is located under the firebox. If the trim or front is already installed, remove the barrier screen at the front of the fireplace.

To adjust the air shutter:

1. Locate the aeration lever under the firebox on the left side.

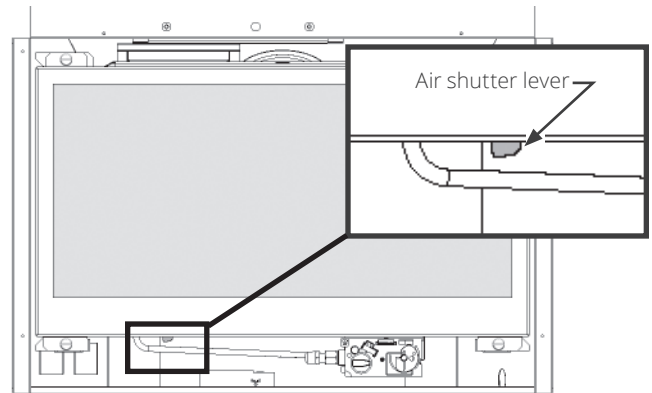

2. Move the lever left or right to the desired position.

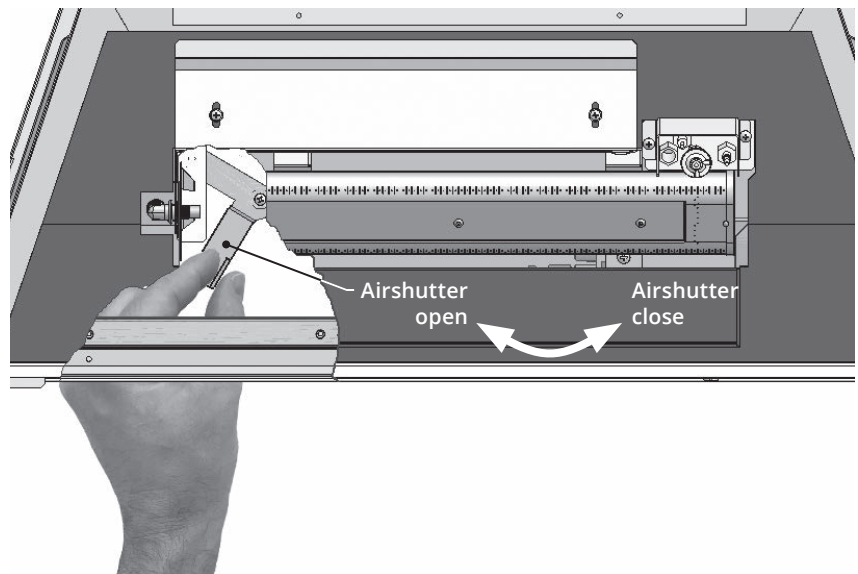

Installation

Accessories

Side Shrouds

The side shrouds are required to install the front on the appliance. They are supplied with the engine.

Fit them to the appliance outer case as indicated (2 screws/side).

Note that some backing plate may need to be installed before the shroud. See instructions supplied with the front, trim, backing plate for installation specifics.

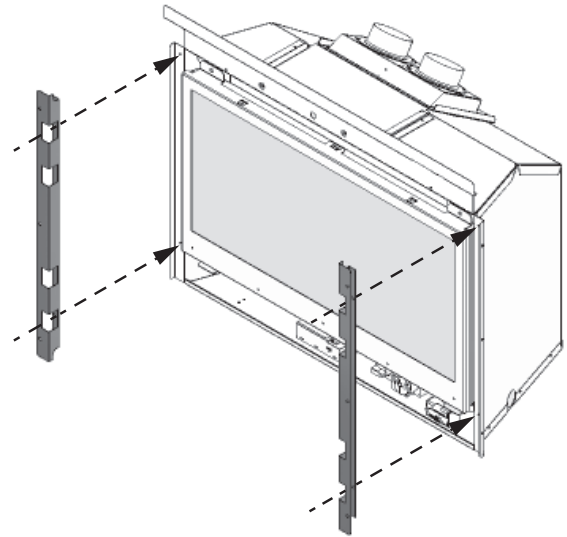

Front, Trim and Barrier Screen

Install the front, trim or backing plate chosen by the customer for their fireplace. Install as well the barrier screen which is provided with the front or trim.

Show the customer how to access the controls when the front or trim are installed and how to remove them.

Follow the instructions provided with the front, trim and backing plate and leave those instructions behind for the customer's further reference.

Handset Wall Holder

The remote control kit for this fireplace comes complete with a wall-mounted holder. This holder is not required in all installations but is provided as an optional feature for those customers who wish to mount the remote handset to the wall.

To install the holder to the wall, find a convenient location and use the hardware provided with the kit.

See the diagram below for required hardware and configurations. Note that the holder can be installed at the base of a light switch plate.

IMPORTANT. The location of the remote control handset is important to assure proper temperature regulation. To obtain a constant temperature, we recommend that the handset should be between 3 and 15 feet away from the appliance **but not directly above it.** We also advise that the handset should be located away from any other heat source and not in direct sunlight as this may affect the temperature sensor located in the remote handset.

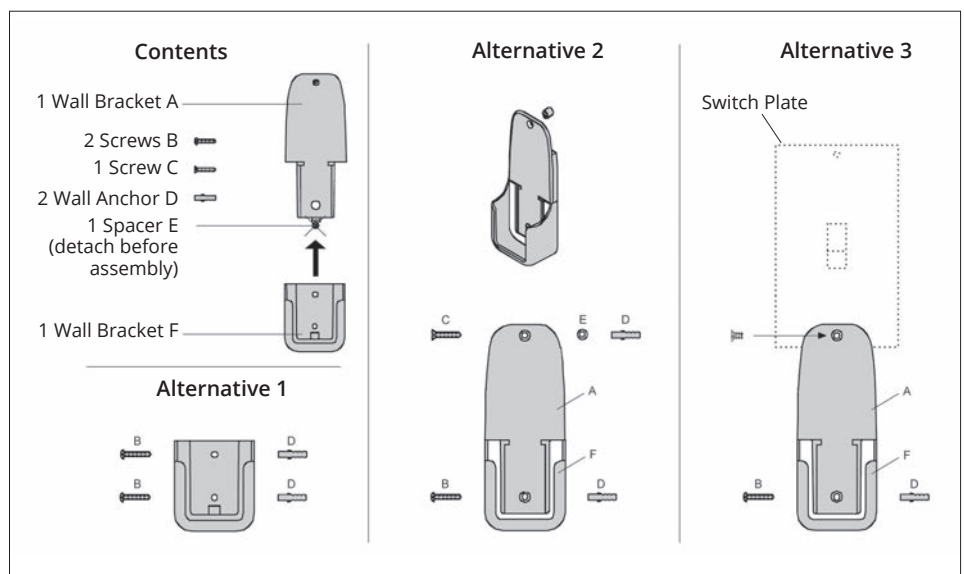

Wiring Diagram

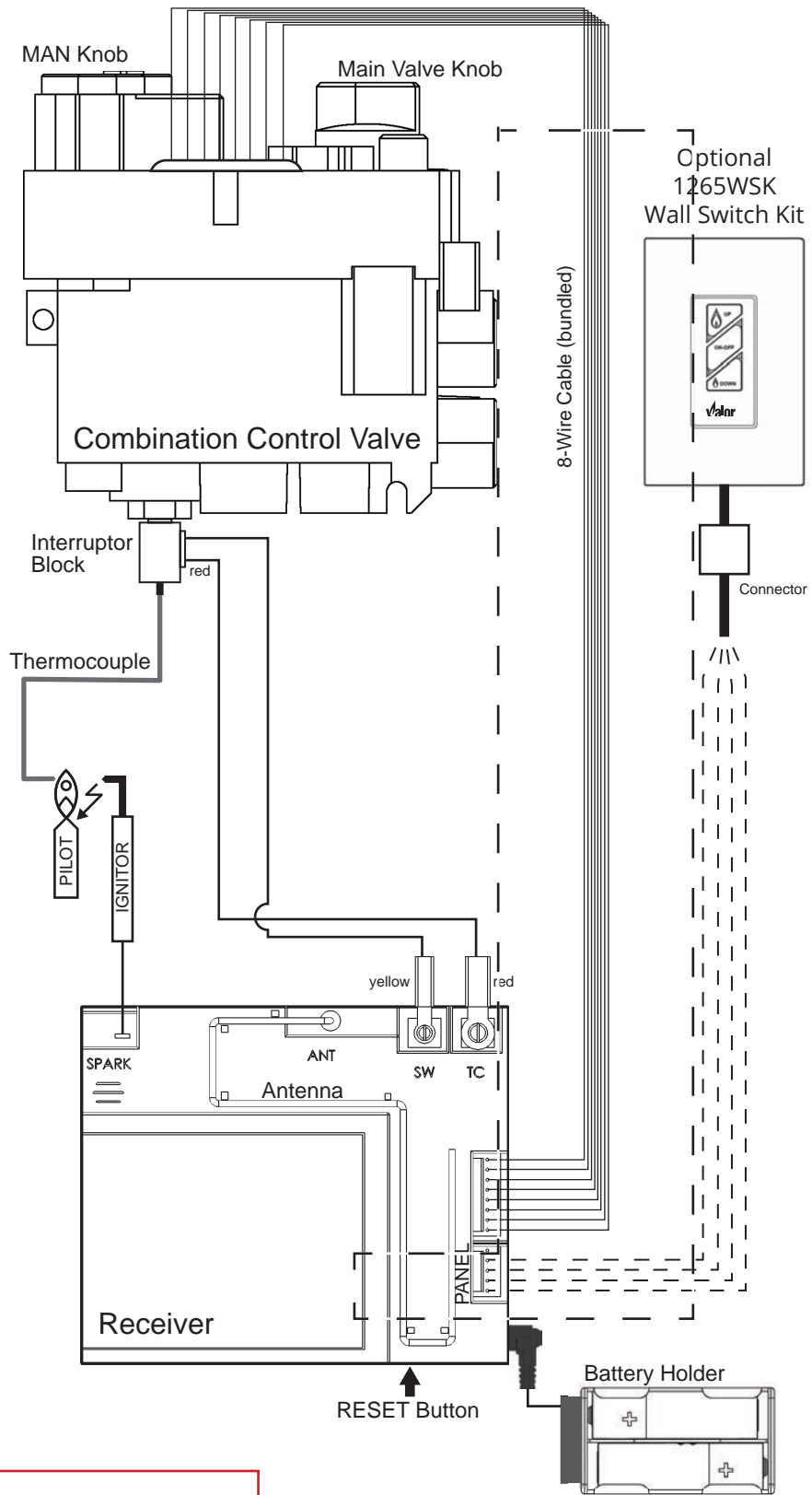

GV60 Wiring Diagram



WARNING

NO ELECTRICAL CONNECTION ALLOWED
for any outdoor installation!

Approved Venting Components

| Approved Direct Vent Suppliers for Valor Models 700 ³ , 739 ² , 780 ³ and 785 ⁴ | | | | | | | |
|---|-----------------------------------|---|---|------------------|----------------------|---|--|
|   Venting Parts Description | | Venting Parts Code / availability by Manufacturer | | | | | |
| | | DURA-VENT | SELKIRK | ICC EXCEL DIRECT | AMERIVENT | MILES INDUSTRIES | BDM |
| Termination Caps | Vertical | Standard Co-axial | 46DVA-VC | 4DT-VT | — | 4DVC 4DH-1313 | — DVR6-VCH DVR6-VCSB |
| | | High Wind Co-axial | 46DVA-VCH | — | TM-4SVT | — | — |
| | | Extended Co-axial | 46DVA-VCE | — | — | — | — |
| | Horizontal | Co-linear | 46DVA-CL33 46DVA-CL33H 46DVA-CL33P | — | TM-IVT | HCL-99-33 HCL-913-33 HCL-1313-33 | 559CLT 940033B 940033HWS 940033RD |
| — | | | — | — | — | 720SWK-M for 739M & 739V 720SWK-M2 for 700M & 780M | — |
| Vent Adapters / Couplers | Universal Adapter 3” Flex Coupler | | 2150 | — | TM-CFAA3 | — | 95090390 |
| | Co-linear Flex Connector | | 46DVA-ADF | — | — | — | — |
| | Co-linear-to-Co-axial Adapter | | 46DVA-GK 46DVA-CLTA | — | TM-4CTA | 4DCAT33 | — |
| Aluminum Flexible Liner | 3” diameter | | NOTE: 2-ply liner approved to CAN/ULC S635 suitable for venting gas appliances. As manufactured by Z-Flex, Flexmaster and others. | | | | |
| | | | 2280 Series | AF3-35L | TM-ALK33 TM-ALT33 | — | — |
| Flashings | Roof Flashing 0/12-6/12 | | 46DVA-F6 | 4DT-AF6 | TF-4FA | 4DF (0/12-5/12) | — DVR6-AF012 |
| | Roof Flashing 7/12-12/12 | | 46DVA-F12 | 4DT-AF12 | TF-4FB | 4DF12 (6/12-12/12) | — DVR6-AF712 |
| | Flat Roof Flashing | | 46DVA-FF | — | TF-4F | — | — DVR6-TCF |
| | Masonry Flashing | | — | — | TF-4MF | — | 559FSK |

- Notes:**
1. Follow instructions supplied with each manufacturer's components.
 2. The 720SWK-M Sidewall Kit can only be installed on the 739M and 739V models.
 3. The 720SWK-M2 Sidewall Kit can only be installed on the 700M and 780M models.
 4. The 720SWK-M2 Sidewall Kit CANNOT be installed on the 785Y models.

Commonwealth of Massachusetts

State of Massachusetts Carbon Monoxide Detector/Vent Terminal Signage Requirements

For all side wall horizontally vented gas fueled equipment installed in every dwelling, building or structure used in whole or in part for residential purposes, including those owned or operated by the Commonwealth and where the side wall exhaust vent termination is less than seven (7) feet above finished grade in the area of the venting, including but not limited to decks and porches, the following requirements shall be satisfied:

1. INSTALLATION OF CARBON MONOXIDE DETECTORS.

At the time of installation of the side wall horizontal vented gas fueled equipment, the installing plumber or gas fitter shall observe that a hard wired carbon monoxide detector with an alarm and battery back-up is installed on the floor level where the gas equipment is to be installed. In addition, the installing plumber or gas fitter shall observe that a battery operated or hard wired carbon monoxide detector with an alarm is installed on each additional level of the dwelling, building or structure served by the side wall horizontal vented gas fueled equipment. It shall be the responsibility of the property owner to secure the services of qualified licensed professionals for the installation of hard wired carbon monoxide detectors.

a. In the event that the side wall horizontally vented gas fueled equipment is installed in a crawl space or an attic, the hard wired carbon monoxide detector with alarm and battery back-up may be installed on the next adjacent floor level.

b. In the event that the requirements of this subdivision can not be met at the time of completion of installation, the owner shall have a period of thirty (30) days to comply with the above requirements; provided, however, that during said thirty (30) day period, a battery operated carbon monoxide detector with an alarm shall be installed.

2. APPROVED CARBON MONOXIDE DETECTORS. Each carbon monoxide detector as required in accordance with the above provisions shall comply with NFPA 720 and be ANSI/UL 2034 listed and IAS certified.

3. SIGNAGE. A metal or plastic identification plate shall be permanently mounted to the exterior of the building at a minimum height of eight (8) feet above grade directly in line with the exhaust vent terminal for the horizontally vented gas fueled heating appliance or equipment. The sign shall read, in print size no less than one-half (1/2) inch in size, "GAS VENT DIRECTLY BELOW. KEEP CLEAR OF ALL OBSTRUCTIONS".

4. INSPECTION. The state or local gas inspector of the side wall horizontally vented gas fueled equipment shall not approve the installation unless, upon inspection, the inspector observes carbon monoxide detectors and signage installed in accordance with the provisions of 248 CMR 5.08(2)(a)1 through 4.

(b) EXEMPTIONS: The following equipment is exempt from 248 CMR 5.08(2)(a)1 through 4:

1. The equipment listed in Chapter 10 entitled "Equipment Not Required To Be Vented" in the most current edition of NFPA 54 as adopted by the Board; and

2. Product Approved side wall horizontally vented gas fueled equipment installed in a room or structure separate from the dwelling, building or structure used in whole or in part for residential purposes.

(c) MANUFACTURER REQUIREMENTS - GAS EQUIPMENT VENTING SYSTEM PROVIDED. When the manufacturer of Product Approved side wall horizontally vented gas equipment provides a venting system design or venting system components with the equipment, the instructions provided by the manufacturer for installation of the equipment and the venting system shall include:

1. Detailed instructions for the installation of the venting system design or the venting system components; and

2. A complete parts list for the venting system design or venting system.

(d) MANUFACTURER REQUIREMENTS - GAS EQUIPMENT VENTING SYSTEM NOT PROVIDED.

When the manufacturer of a Product Approved side wall horizontally vented gas fueled equipment does not provide the parts for venting the flue gases, but identifies "special venting systems", the following requirements shall be satisfied by the manufacturer:

1. The referenced "special venting system" instructions shall be included with the appliance or equipment installation instructions; and

2. The "special venting systems" shall be Product Approved by the Board, and the instructions for that system shall include a parts list and detailed installation instructions.

(e) A copy of all installation instructions for all Product Approved side wall horizontally vented gas fueled equipment, all venting instructions, all parts lists for venting instructions, and/or all venting design instructions shall remain with the appliance or equipment at the completion of the installation.

Appendix A - Lighting Instructions Plate

FOR YOUR SAFETY, READ BEFORE LIGHTING

WARNING: If you do not follow these instructions exactly a fire or explosion may result causing property damage, personal injury or loss of life.

A. This appliance has a pilot which must be lighted by hand or by remote control. Follow these instructions exactly. To save gas, turn the pilot off when not using the appliance for a prolonged period of time.

B. **BEFORE LIGHTING**, smell all around the appliance area for gas. Be sure to smell next to the floor because some gas are heavier than air and will settle on the floor.

WHAT TO DO IF YOU SMELL GAS

- Do not try to light any appliance.
- Do not touch any electric switch; do not use any phone in your building.
- Immediately call your gas supplier from a neighbor's phone. Follow the gas supplier's instructions.
- If you cannot reach your gas supplier, call the fire department.

C. Use only your hand to push in or turn the control knobs. Never use tools. If the knobs will not push in or turn by hand, don't try to repair them; call a qualified service technician. Force or attempted repair may result in a fire or explosion.

D. Do not use this appliance if any part has been under water. Immediately call a qualified service technician to inspect the appliance and to replace any part of the control system and any gas control, which has been under water.

LIGHTING INSTRUCTIONS

1. STOP! Read the safety information above

2. TO CLEAR ANY GAS, turn main valve off by pressing OFF (red dot) button on remote handset (1).

- Wait five (5) minutes to clear out any gas, then smell for gas, including near the floor. If you smell gas, STOP! Follow "B" in the safety information above on this label. If you don't smell gas, go to the next step.

3. **AUTOMATIC IGNITION:** MAN-knob (2) in ON position. Ensure Flame Adjustment knob (3) is set to lowest setting (U) (Fig. 1). Locate the pilot (Fig. 3) inside firebox.

- On the remote control handset, press the OFF button (red dot) and large flame button (🔥) simultaneously; a short acoustic signal confirms the start has begun.
- Further short acoustic signals indicate the ignition process is in progress.
- When the pilot is lit, the Flame Adjustment knob (3) will automatically rotate to the highest setting.
- Press the small flame button (🔥) on the remote.

4. **MANUAL IGNITION:** MAN-knob (2) in MAN position (Fig. 2).

With the window off, locate the pilot (Fig. 3) inside firebox.

- Set Flame Adjustment knob (3) to the lowest setting (U).
- Push down the metallic core (4) with a pin or similar instrument; this will establish the pilot gas flow.
- Light gas at the pilot (5) with a match.
- Continue holding down metal core (4) for about 10 seconds; after release, pilot should remain lit.
- If the pilot will not stay lit after several tries, turn the gas control knob (3) to OFF (U) and call your local service technician or gas supplier.
- Reinstall the window and set the MAN-knob (2) to ON; turn Flame Adjustment knob (3) up (U) or down (U) manually or use the flame buttons (🔥) (🔥) on the remote control handset to adjust the flame height.

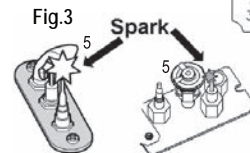
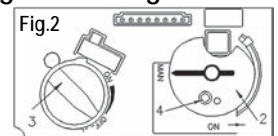
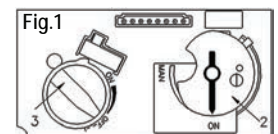
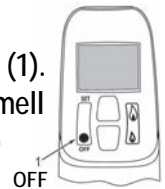

TO TURN OFF GAS TO APPLIANCE

1. **AUTOMATIC SHUT-OFF** (using the remote control handset):

- Press and hold the small flame on the remote control handset to shut-off the main burner gas flow;
- Press "OFF" button (red dot) on remote handset to shut-off the appliance, including pilot flame.

Appendix B - Remote Control Operation

Radio Frequency

315 MHz for USA and Canada.

This device complies with Part 15 of the FCC Rules and with Industry Canada license-exempt RSS standard(s). Operation is subject to the following two conditions:

- (1) this device may not cause harmful interference, and
- (2) this device must accept any interference received, including interference that may cause undesired operation.

NOTE: Before using the remote control system for the first time, the receiver and the handset must be synchronized. See the section *Remote Control Pairing*.

IMPORTANT: BEFORE YOU BEGIN, please note that on this system, the settings of time, temperature and automatic ON/OFF **can only be programmed when the function display is flashing.** Be patient when programming as it can take a few seconds to set.

Note: In the TEMP or TIMER modes, the remote handset senses the room temperature and adjusts the flame accordingly.

To communicate, the handset should be within 15 feet (4.5 meters) of the fireplace.

Do not leave the handset on the mantel or hearth.

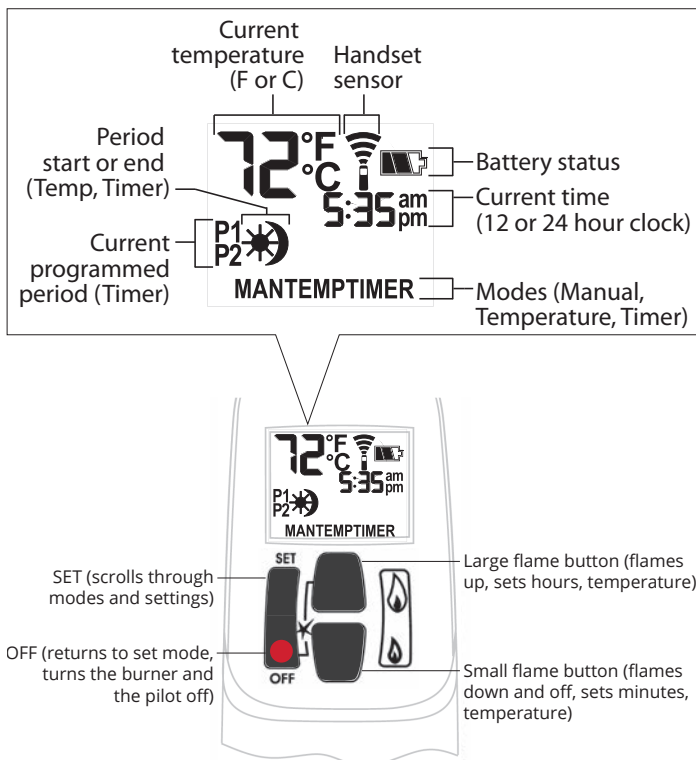

Turn Fireplace ON

Press ● + 🔥 buttons until you hear a short beep; release buttons.

Beeping continues until pilot is lit.

Burner lights to maximum flame height and handset goes automatically to manual (MAN) mode.

NOTES:

On the valve, MAN button must be at ON, in full counter-clockwise position ↺.

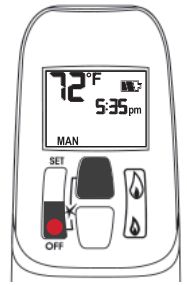

Turn Fireplace OFF

Press ● button.

When pilot is just turned off, wait 2 minutes to light it again.

Standby Mode (Pilot Flame)

Press and hold 🔥 to set fireplace to pilot.

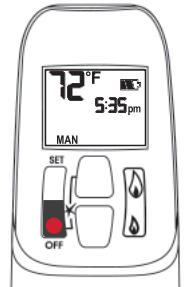

Adjust Flames Height

With pilot lit, press and hold buttons:

- 🔥 = increase flame height
- 🔥 = decrease flame height or set to pilot

For fine adjustment, tap buttons.

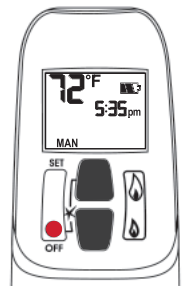

Express Low and High Fire

Double-click buttons:

- 🔥 = increase flame to maximum height "HI"
- 🔥 = decrease flame minimum height "LO"

NOTE: Flame goes to high fire first before going to designated low fire.

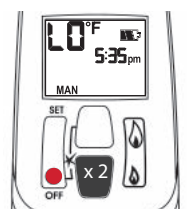
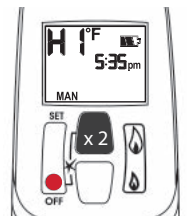

Appendix B - Remote Control Operation

Setting °C/24-hr or °F/12-hr clock

In MAN mode, press and hold ● + 🔥 buttons until temperature / clock display changes from

°F / 12-hour ↔ °C / 24-hour

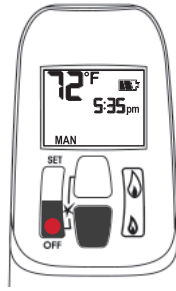

Setting Time

The time display will flash after either:

- installing the battery, or
- pressing 🔥 + 🔥

To set the time, press buttons:

🔥 = hour

🔥 = minutes

Press ● or wait to go back to MAN.

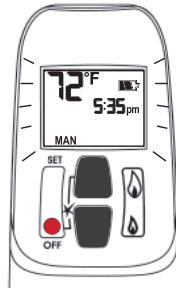

Modes of Operation

Briefly pressing SET cycles through modes of operation.

MAN > ⚙️ TEMP > 🌙 TEMP > TIMER > 🔥

NOTE: Press 🔥 or 🔥 to reach MAN mode.

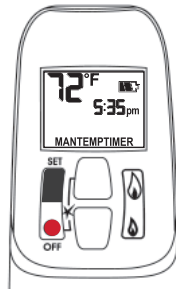

MAN Manual Mode

Manual flame height adjustment.



⚙️ TEMP Daytime Temperature Mode

When pilot is lit, room temperature is measured and compared to set temperature. Flame height automatically adjusts to reach Daytime Set Temperature.



🌙 TEMP Night time Setback Temperature Mode

When pilot is lit, room temperature is measured and compared to set temperature. Flame height automatically adjusts to reach Night Time Setback Temperature.

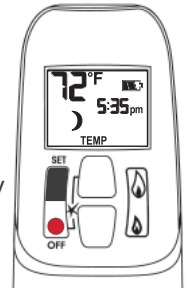

TIMER Timer Mode

When pilot is lit, two periods of time (P1 and P2) can be programmed to use Daytime and Night time temperatures at specific times.

Note: Display shows set temperature every 30 seconds.

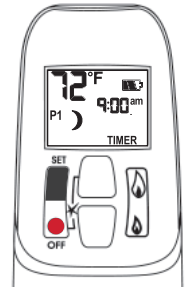

Set the different parameters when they are flashing.

Appendix B - Remote Control Operation

Setting high / low Temperatures

Setting "DAYTIME" high temperature.

Default Settings:  TEMP 23 °C/74 °F

Press SET to scroll to  TEMP

Hold SET button until TEMP flashes.

To set  Daytime Temperature:

 = increases temperature.

 = decreases temperature.

Press  or wait to complete setting.

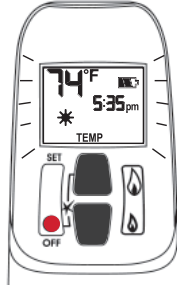

Setting "NIGHT TIME SETBACK" low temperature.

Default Settings:  TEMP "--" (OFF)

Press SET to scroll to  TEMP

Hold SET button until TEMP flashes.

To set  Night Time Temperature:

 = increases temperature.



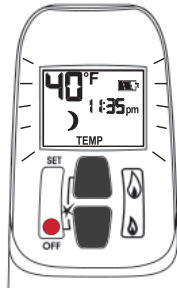

 = decreases temperature.

Press  or wait to complete setting.



Setting Program Timers



You can program two periods of time between 12 am and 11:50 pm in each 24-hour cycle.

Programs P1 and P2 must be set in the following order during a 24-hour cycle: P1 , P1 , P2  and P2 .

 = Day Time temperature (high) program period

 = Night Time temperature (low) program period





Default Settings:

Program 1: P1  06:00 am P1  08:00 am





Program 2: P2  11:50 pm P2  11:50 pm

Press SET to scroll to .



If P1  = P1  or P2  = P2 , programming is cancelled.

To keep fireplace ON all night, set P2  at 11:50 am and P1  at 12:00 am.

If you want to program only one period, program P1  and P1  with desired times then P2  and P2  with the same time as P1 .

Setting P1 time—high temperature.

Hold SET button until P1  is displayed and time flashes.

To set time:

 = hour

 = minutes

Press  or wait to complete setting.

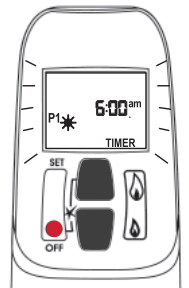

Setting P1 time—low temperature.

Hold SET button until P1  is displayed and time flashes.

To set time:

 = hour

 = minutes

Press  or wait to complete setting.

Appendix B - Remote Control Operation

Setting P2 high and low temperature times.

Repeat same steps as Setting P1.

When all settings are complete, press ● to save them.

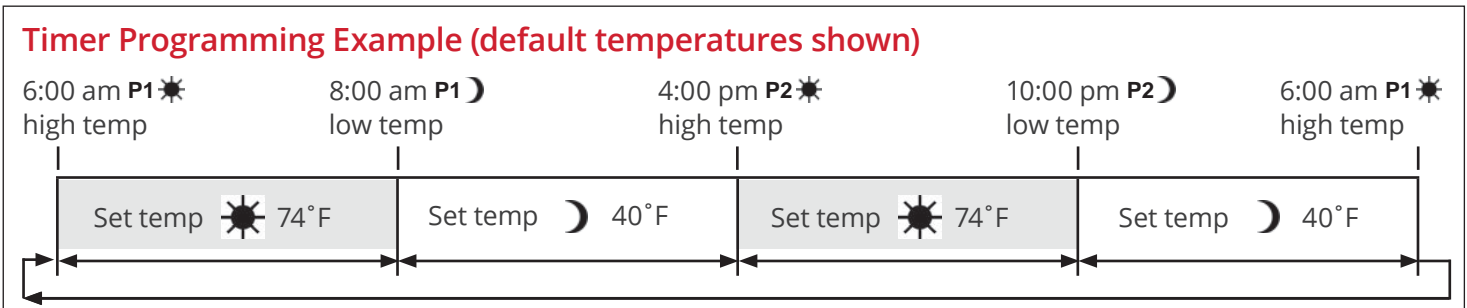

Automatic Turn Down

8-Hour no Motor Movement

The valve will turn to pilot flame if there is no motor movement for an 8-hour period.

Automatic Shut-Off

Low Batteries Receiver. With low battery power in the battery holder the system shuts off the fire completely. This does not apply when the power supply is interrupted.

On-Demand Pilot (7 Day Shut-Off). This green feature eliminates gas energy consumption during extended appliance inactivity. When the appliance is inactive for an extended period of time the system automatically extinguishes the pilot. This feature helps the consumer realize cost benefits by automatically eliminating energy consumption during non-heating months and limited use.

The programmed length of inactivity to activate the system is specified by the appliance manufacturer and cannot be altered in the field.

Low Battery Indication

⚠ Caution

DO NOT USE a screwdriver or other metallic object to remove batteries from holder. This could cause a short-circuit.

Handset: The battery icon  will show when the battery needs to be replaced. Replace with one 9 V **alkaline** battery.

Battery holder: Frequent 'beeps' for 3 seconds when the valve motor turns indicate the batteries need to be replaced in battery holder. Replace with four 1.5 V **alkaline** batteries.

Handset / Receiver Match

The remote control handset and receiver are programmed to function together. In case of a replacement of the handset or the receiver, you will need to reset the receiver to allow them to function together. Contact your dealer for details.

Appendix C - Spare Parts

| | Description | Part Number |
|----|-------------------------------------|-------------|
| 1 | AutoFire vent plate assembly | 4006539 |
| 2 | Exhaust vent plate gasket | 4001662 |
| 3 | 2.5-4.5" hose clamp (2) | 4000768 |
| 4 | Fan closure plate | 4001136 |
| 4a | Levelling screws (2) | 4000242 |
| 5 | Side brick anchors (2) | 4001283 |
| 6 | Top mounting bracket | 4000136AZ |
| 7 | Side mounting brackets (2) | 4000135AZ |
| 8 | Rear log support | 4008289 |
| 9 | Burner cover platform | 4008432AH |
| 10 | Port cover | 4001820 |
| 11 | Window assembly | 4001378 |
| 12 | Hot glass warning plate | 4003093 |
| 13 | Module assembly (natural gas) | 4008735S |
| | Module assembly (propane) | 4008736S |
| 14 | Platform fixing bracket | 4008430 |
| 15 | Burner with bracket | 4007354AH |
| 16 | Burner mounts (2) | 4008431 |
| 17 | Flat washers (2) | 4007638 |
| 18 | Nuts, M5 x 8 Hex (2) | 110K290 |
| 19 | Anti-flashback shield | 4007629 |
| 20 | Air shutter (natural gas) | 4007136 |
| | Air shutter (propane) | 4008699 |
| 21 | Spring tension washer | 4007460 |
| 22 | Steel flat washer | 4007461 |
| 23 | Injector elbow 82-750 (natural gas) | 4000738 |
| | Injector elbow 92-260 (propane) | 9730007 |
| 24 | Pilot shield | 4008555AH |
| 25 | Pilot assembly (natural gas) | 4000727 |
| | Pilot assembly (propane) | 4000728 |
| 26 | Thermocouple | 4000061 |
| 27 | Pilot injector #51 (natural gas) | 4000735 |
| | Pilot injector #30 (propane) | 4000736 |
| 28 | Pilot hood 2-flame (offset) | 4000730 |
| 29 | Pilot hood spring clip | 4008520 |
| 30 | Pilot tube | 4000732 |
| 31 | Electrode, short | 4001856 |
| 32 | Nut for short electrode | 4001855 |
| 33 | Pilot mounting bracket | 4007142 |
| 34 | Pilot sealing plate | 4002910 |
| 35 | Burner module plate | 4008779 |
| 36 | Gasket, module plate rear | 4000175 |
| 37 | Gasket, module plate right side | 4000174 |
| 38 | Gasket, module plate front | 4000173 |

| | Description | Part Number |
|----|--------------------------------------|-------------|
| 39 | Gasket, module plate left side | 4000181 |
| 40 | Gasket, injector pipe | 620C016 |
| 41 | Thermal switch retainer | 4001519 |
| 42 | Link bracket, aeration | 4008697 |
| 43 | Aeration lever | 4008698 |
| 44 | Spring washer, 3/16 x 9/16 (2) | 4006691 |
| 45 | #10-24 Steel reverse lock nut (2) | 4007890 |
| 46 | #10 x 0.562 washers (2) | 4006692 |
| 47 | M4 prevailing type hex nut zp | 4006045 |
| 48 | Screw M4-10 PN HD PH zinc | 100D095 |
| 49 | Pipe, valve to injector elbow | 4008917 |
| 50 | Valve mount | 4000141 |
| 52 | GV60 Valve assembly (natural gas) | 4008862X |
| | GV60 Valve assembly (propane) | 4008863X |
| 53 | Thermocurrent interruptor | 4001037 |
| 54 | Receiver PLUS | 4001911 |
| 55 | Yellow cable to interruptor | 4002096 |
| 56 | Red cable to interruptor | 4001035 |
| 57 | Ignition cable 500 mm | 4001039 |
| 58 | Insulating sleeve, ignition cable | 4002244 |
| 59 | Wiring harness GV60 valve | 4001187 |
| 60 | Remote control handset PLUS | 4001910 |
| 61 | Handset wall holder | 9000008 |
| 62 | Battery holder BH-343-3B6 | 4006553 |
| 63 | Battery holder cable 1500 mm | 4006552 |
| 64 | GV60 valve repair kit (not included) | 4004544 |
| 65 | Ceramic liner sets (complete) | |
| | Fluted black | 739FBL |
| | Valor Red Brick | 739VRL |
| | Reflective glass | 739RGL |
| 66 | Rear panel | |
| | Fluted black | 4001814 |
| | Valor Red Brick | 4001811 |
| | Reflective glass | 4005017 |
| 67 | Left hand panel | |
| | Fluted black | 4001812 |
| | Valor Red Brick | 4001809 |
| | Reflective glass | 4005015 |
| | Filler panel | 4005018 |
| 68 | Right hand panel | |
| | Fluted black | 4001813 |
| | Valor Red Brick | 4001810 |
| | Reflective glass | 4005016 |

Appendix C - Spare Parts

| | Description | Part Number |
|----|-------------------------------|-------------|
| | Side spacers for RH panel (4) | 4004711AH |
| 69 | Birch log kit | 739VBLK |
| | Birch log #G1 | 4008159 |
| | Birch log #G23 | 4008768 |
| | Birch log #G25 | 4008952 |
| | Birch log #G5 | 4008163 |
| | Birch log #G6 | 4008164 |
| | Birch log #H7 | 4007465 |
| | Ember bed #G4 | 4008162 |
| | Ember chunks (3) | 4008764 |
| | Embers, large, 2-cup bag | 4008304 |
| 70 | Driftwook kit | 739VDWK |
| | Driftwood log #G24 | 4008769 |
| | Driftwood log #G11 | 4008169 |
| | Driftwood log #G14 | 4008172 |
| | Driftwood log #G15 | 4008305 |
| | Driftwood log #G26 | 4008953 |
| | Driftwood log #H20 | 4007499 |
| | Ember bed #G4 | 4008162 |
| | Pebbles (3) | 4008173 |
| | Embers, large, 2-cup bag | 4008304 |
| 71 | Traditional log kit | 739VLSK |
| | Traditional log #H28 | 4007505 |
| | Traditional log #G9 | 4008167 |
| | Traditional log #G21 | 4008763 |
| | Traditional log #G20 | 4008762 |
| | Traditional log #G16 | 4008306 |
| | Traditional log #G10 | 4008168 |
| | Ember bed #G4 | 4008162 |
| | Ember chunks (3) | 4008764 |
| | Embers, large, 2-cup bag | 4008304 |

Appendix C - Spare Parts

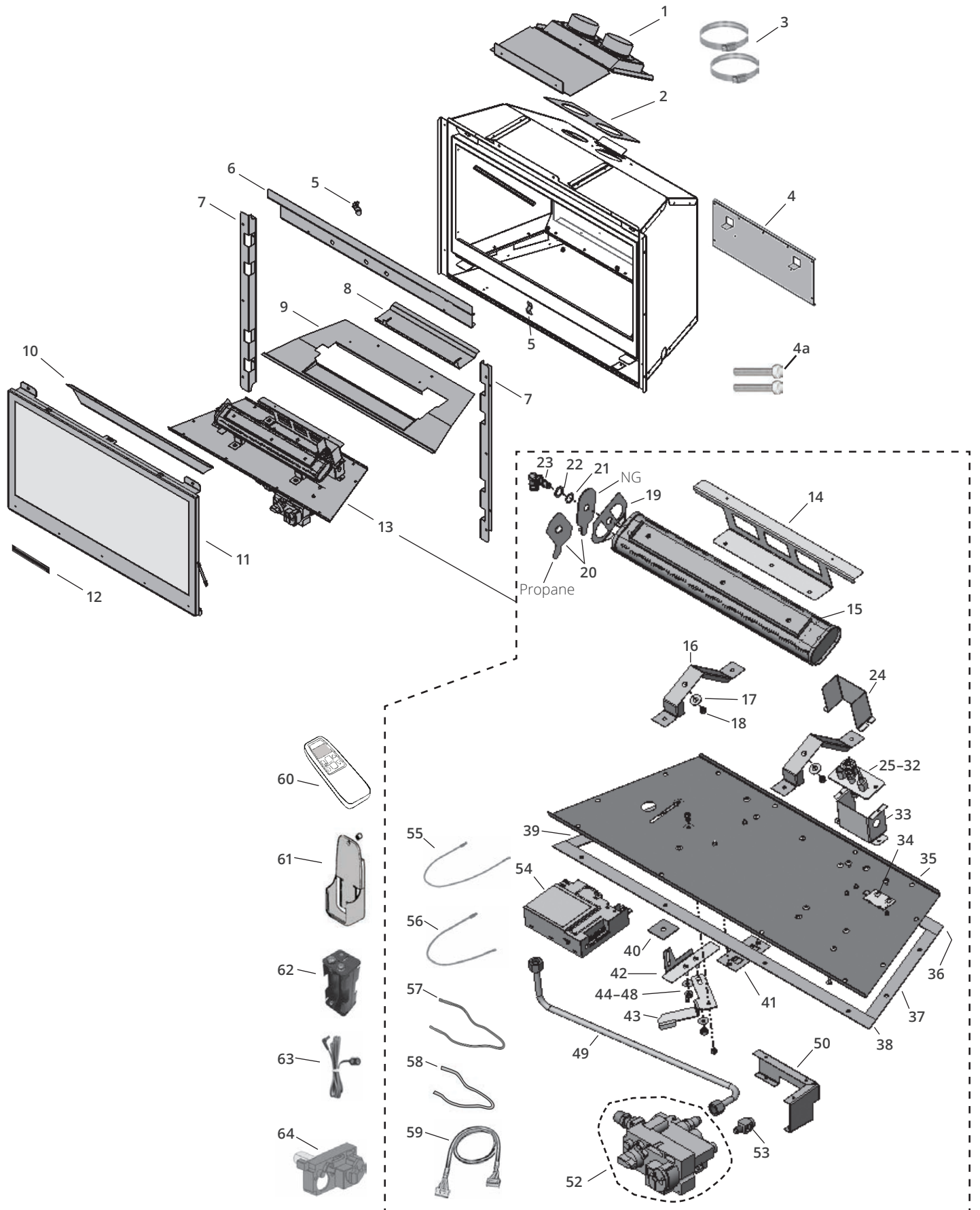

Appendix C - Spare Parts

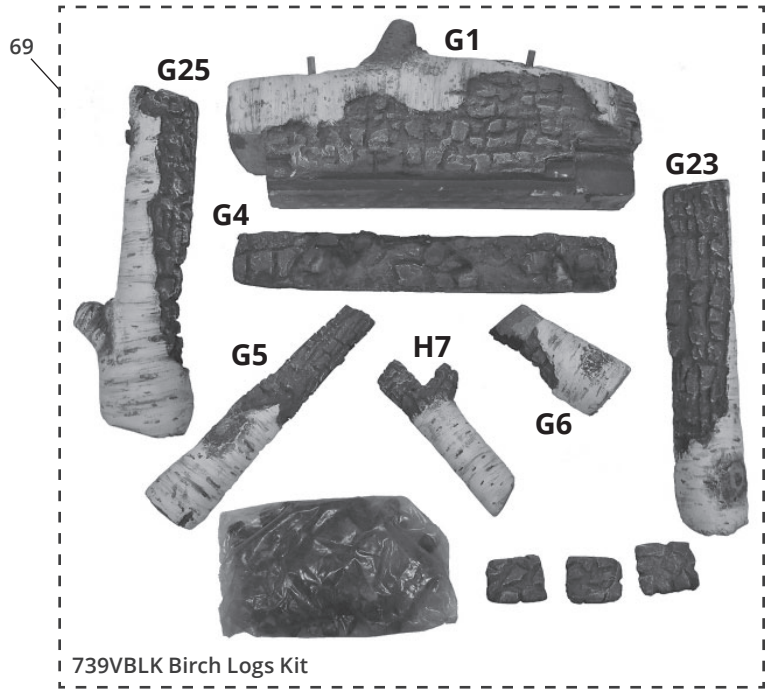
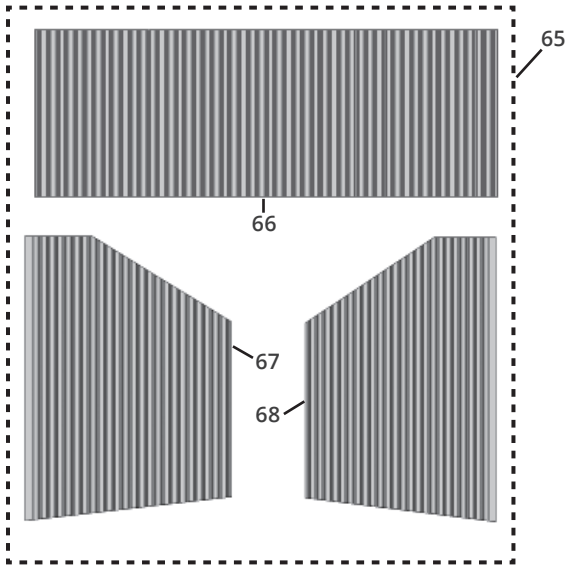

739VBLK Birch Logs Kit

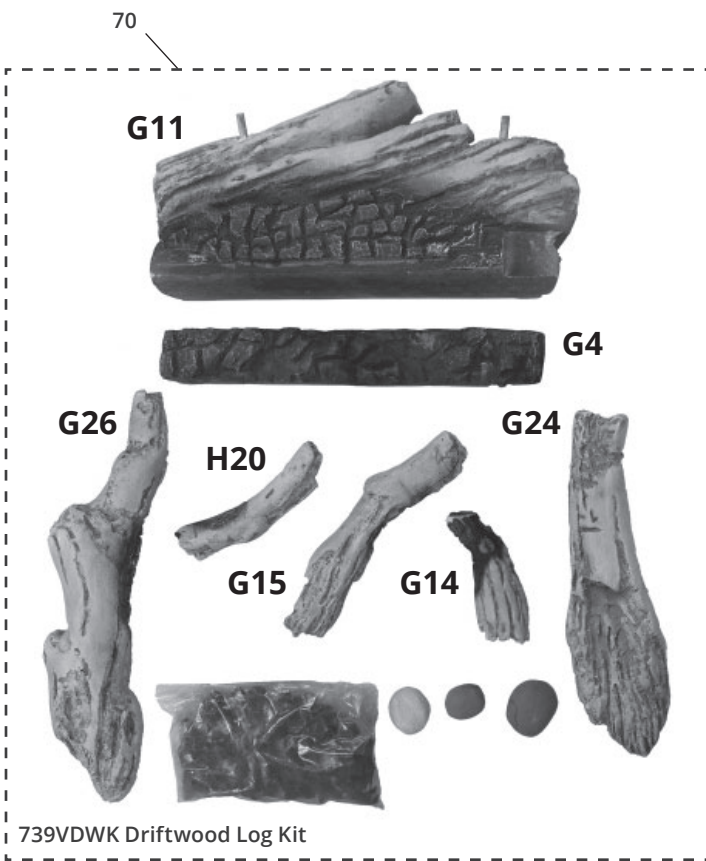

739VDWK Driftwood Log Kit



739VLSK Traditional Log Kit