

Homeowner's Manual



LX

Gas Fireplaces

natural gas 2100PKN / 2200KN / 2200LKN / 2200RKN

propane gas 2100PKP / 2200KP / 2200LKP / 2200RKP

⚠ WARNING:
FIRE OR EXPLOSION HAZARD
Failure to follow safety warnings exactly could result in serious injury, death, or property damage.

Do not store or use gasoline or other flammable vapors and liquids in the vicinity of this or any other appliance.

WHAT TO DO IF YOU SMELL GAS

- Do not try to light any appliance.

- Do not touch any electrical switch; do not use any phone in your building.
- Leave the building immediately.
- Immediately call your gas supplier from a neighbor's phone. Follow the gas supplier's instructions.
- If you cannot reach your gas supplier, call the fire department.

Installation and service must be performed by a qualified installer, service agency or the gas supplier.

⚠ DANGER



Hot glass will cause burns.

Do not touch glass until cooled.

Never allow children to touch glass.

A barrier designed to reduce the risk of burns from the hot viewing glass is provided with this appliance and must be installed for the protection of children and other at-risk individuals.

This appliance may be installed in an after-market permanently located, manufactured (mobile) home where not prohibited by local codes. This appliance is only for use with the type of gas indicated on the rating plate. This appliance is not convertible for use with other gases, unless a certified kit is used.

INSTALLER: Leave this manual with the appliance.

CONSUMER: Retain this manual for future reference.

Massachusetts:

The piping and final gas connection must be performed by a licensed plumber or gas fitter in the State of Massachusetts. Also, see Carbon Monoxide Detector requirements in the fireplace installation manual.

⚠ WARNING

This product can expose you to chemicals including Benzene, which is known to the State of California to cause cancer and birth defects or other reproductive harm.

For more information go to www.P65Warnings.ca.gov.

Note: Natural gas, in its original state, contains Benzene.

The information contained in this manual is believed to be correct at the time of printing. Miles Industries Ltd. reserves the right to change or modify any information or specifications without notice. Miles Industries Ltd. grants no warranty, implied or stated, for the installation or maintenance of your heater, and assumes no responsibility for any consequential damage(s).

© Copyright Miles Industries Ltd., 2024. All rights reserved.
Designed and manufactured for Miles Industries Ltd.



We recommend a US Certified National Fireplace Institute (NFI) specialist install our gas hearth products.

Valor Fireplaces
190-2255 Dollarton Highway
North Vancouver, BC, Canada V7H 3B1
T 604.984.3496 F 604.984.0246
valorfireplaces.com

Welcome to Valor®

Thank you for purchasing a **Valor Fireplace**. We appreciate your business and wish you many happy years enjoying your new fireplace.

Your new radiant gas heater is a technical appliance that must be installed by a qualified dealer. Each Valor® fireplace is fully tested during the production process for your safety and comfort.

Your unit has been professionally installed by:

Dealer Name: _____

Phone: _____

If you experience any problems, call your dealer immediately. To avoid injury or damage to your fireplace, do not try to repair the unit yourself.

Your Valor Fireplace

Here are some important details about your Valor fireplace, should you need to contact your dealer.

Model: _____

Serial: _____

Options: _____

Please ask your installer for these details if they are not already provided, or see page 7.

Important—Register your warranty

Registration of your Valor is highly recommended, and can be completed by scanning the QR code on the serial number label placed on the fireplace's installation manual cover by the installer or by visiting valorfireplaces.com/warranty.

Completing your registration enables us to properly address any warranty or service-related concerns that you may have. This information is strictly for customer service and warranty purposes, and will never be shared with any third party.

Homeowner: Please read this manual before operating this appliance, and save for future reference.

Contents

Safety and your fireplace	4
Child safety and your fireplace.....	6
Getting started.....	7
First time operation.....	7
Locating fireplace and lighting information.....	7
Parts of your fireplace.....	8
Operating your fireplace	9
Fireplace control devices.....	9
Preventing inadvertent ignition	10
Replacing batteries.....	11
Replacing light bulbs	12
Annual service and maintenance.....	13
Cleaning your fireplace	14
Checking pilot and burner flames.....	18
Frequently asked questions.....	20
Valor® warranty.....	22
Valor® outdoor installation warranty.....	23
Appendix A-Remote control operation.....	24
Appendix B-Wall switch operation	31

Safety and your fireplace

This manual contains very important information about the safe operation and maintenance of your fireplace. Read and understand all instructions carefully before operating your fireplace. Failure to follow these instructions may result in possible fire hazard and will void the warranty.

Replacement manuals are available by contacting Valor Customer Service at 1-800-468-2567, or by visiting valorfireplaces.com.

WARNING: Extremely Hot!

Heat and flammability

- Some parts of your fireplace are extremely hot, particularly the glass window. Use the provided barrier screen and a gate to reduce the risk of severe burns.
- The glass windows can exceed temperatures of 500°F at full capacity.
- Always keep the appliance clear and free from combustible materials, gasoline, and other flammable vapors and liquids.
- Be aware of hot wall surfaces. The wall directly above the fireplace can get very hot when the fireplace heats. Although safe, it may reach temperatures in excess of 200° F depending on choice of trims or optional accessories. Do not touch!
- Be aware of hot surfaces in front of the fireplace windows. A shelf directly in front of the fireplace can get very hot when the fireplace heats. Although safe, they may reach temperatures in excess of 200° F depending on elevation of the shelf. Do not place anything on it.
- Some materials or items, although safe, may discolor, shrink, warp, crack, or peel due to the heat produced by the fireplace. Avoid placing candles, paintings, photos and other combustible objects sensitive to heat or furniture within 36 inches (0.9 m) around the fireplace.
- Solid wood flooring in front of the fireplace (if allowed) may shrink during the heating season due to heat.
- Due to its high temperature, the appliance should be located away from high-traffic areas, furniture, and draperies.
- Clothing or flammable material should not be placed on or near the appliance.

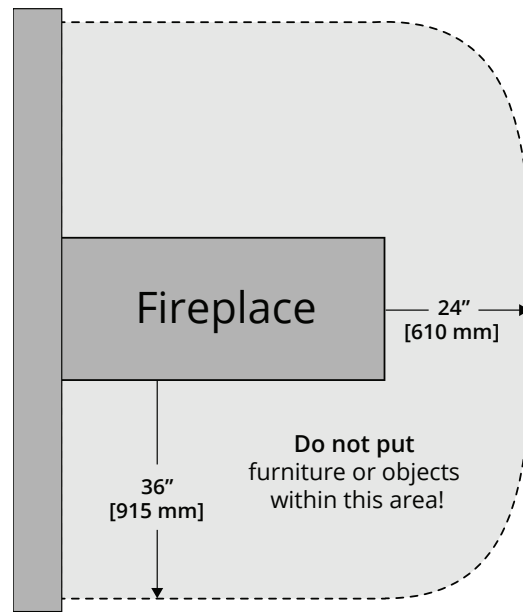

Barrier screen and safety

- A barrier designed to reduce the risk of burns from the hot viewing glass is provided with this appliance and shall be installed for the protection of children and other at-risk individuals.
- Children and adults should be alerted to the hazards of high surface temperature and should stay away to avoid burns or clothing ignition.
- Young children should be carefully supervised when they are in the same room as the appliance. Toddlers, young children, and others may be susceptible to accidental contact burns. A physical barrier is recommended if there are at-risk individuals in the house. To restrict access to a fireplace or stove, install an adjustable safety gate to keep toddlers, young children, and other at-risk individuals out of the room and away from hot surfaces.
- Any safety screen, guard, or barrier removed for servicing an appliance must be replaced prior to operating the appliance.

Safety and your fireplace

Glass window

WARNING

Do not operate this appliance with the glass front removed, cracked, or broken.

Do not strike or slam the glass front.

Replacement of the glass front should be performed by a licensed or qualified service person.

- The glass window fronts must be in place and sealed before the unit can be placed into safe operation.
- The glass fronts must only be replaced as complete units, as supplied by the fireplace manufacturer. No substitute material may be used.
- Do not use abrasive cleaners on the glass front assembly. Do not attempt to clean the glass front when it is hot.

Venting

- This unit must be used with a vent system as described in the installation manual. No other vent system or components may be used.
- Never obstruct the flow of combustion and ventilation air. Keep the front of the appliance clear of all obstructions for optimal operation and ease of servicing.
- This unit must be vented directly outside and must never be attached to a chimney serving a separate solid fuel burning appliance. Each gas appliance must use a separate vent system. Common vent systems are prohibited.

Intended use

- This appliance is designed and approved as a supplemental heater to be used while attended. The use of an alternate primary heat source is advisable.

- This unit is not for use with solid fuel.
- Do not use this heater as a temporary source of heat during construction.

Initial and annual inspection

- Installation and repair should be performed by a qualified service person. The appliance should be inspected before use and at least annually by a professional service person. More frequent cleaning might be required due to excessive lint from carpeting, bedding material, etc. It is imperative that control compartments, burners, and circulating air passageways of the appliance be kept clean.
- Do not use this appliance if any part has been under water. Immediately call a qualified service technician to inspect the appliance and to replace any part of the control system and any gas control that has been under water.

Maintenance

- Keep the unit's control compartment, burner, and circulating air passageways clean to enable adequate combustion and ventilation air.
- Inspect the external vent cap on a regular basis to ensure that no debris, plants, trees, or shrubs are interfering with air flow.

WARNING

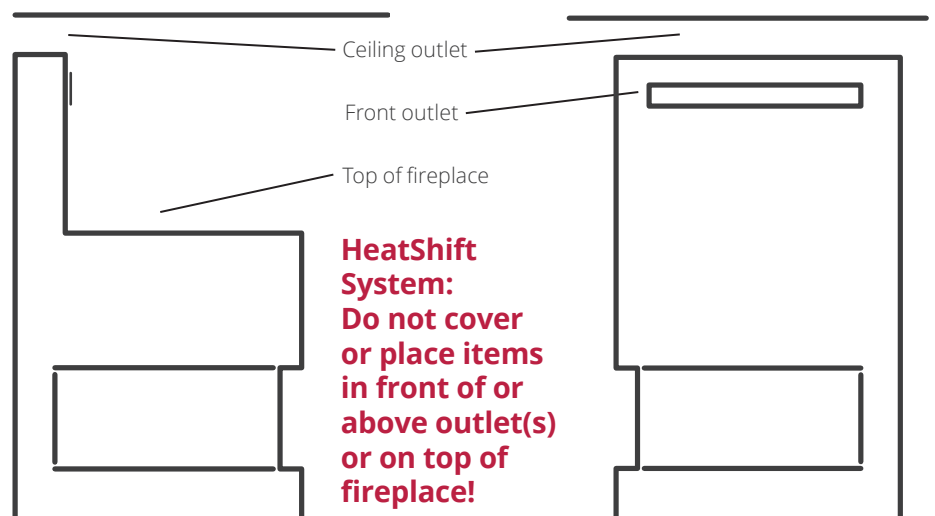

Child safety and your fireplace

DANGER



Hot glass will cause burns.

Do not touch glass until cooled.

Never allow children to touch glass.

A barrier designed to reduce the risk of burns from the hot viewing glass is provided with this appliance and must be installed for the protection of children and other at-risk individuals.

A heating gas appliance does require safe handling. For this reason, we very strongly recommend children not be allowed to touch the fireplace or its controls.

Read and carefully follow all safety warnings and operating instructions contained in this manual, and follow these important child safety precautions and recommendations:

- Parts of your Valor Fireplace become extremely hot while in operation. The glass window temperature can exceed 500° F at full capacity.
- Do not let children touch the glass or any parts of your fireplace even after it is turned off, as the surfaces will remain hot for some time.
- Even momentary contact with a hot glass surface can cause a severe burn, including when the fireplace is operating at reduced heating capacity.
- The glass window will remain hot for an extended period of time after the fireplace has been turned off. Make sure that children do not touch the fireplace during the cool down period.
- Children and adults should be alerted to the hazards of high surface temperature and should stay away to avoid burns or clothing ignition.
- Young children should be carefully supervised when they are in the same room as the appliance. Toddlers, young children, and others may be susceptible to accidental contact burns.
- A physical barrier is recommended if there are at-risk individuals in the house. To restrict access to a fireplace or stove, install an adjustable safety gate to keep toddlers, young children, and other at-risk individuals out of the room and away from hot surfaces.
- Keep the remote control handset out of reach of children at all times. A child safety lockout feature is included with your remote control, see page 10 for details.
- Make sure that the fireplace, including the pilot light, is completely turned off when children are present and close supervision is not available—see page 9 and page 10 for details.
- If the fireplace is not going to be used for an extended period of time, remove the batteries from the remote control handset and battery holder under the firebox. It is recommended that batteries are replaced annually —see page 11 for details.

Getting started

First time operation

When operating your new fireplace for the first time, some vapors may be released due to the burning of curing compounds used during manufacturing. They may cause a slight odor and could cause the flames to be the full height of the firebox, or even slightly higher, for the first few hours of operation.

It is also possible that these vapors could set off any smoke detection alarms in the immediate vicinity. These vapors are quite normal on new fireplaces. We recommend opening a window to vent the room. After a few hours of use, the vapors will have disappeared and the flames will be at their normal height.

Valor automatic gas shut-off

For your safety, Valor fireplaces are fitted with a flame supervision device which will shut-off the gas supply if, for any reason, the pilot flame goes out. This device incorporates a fixed probe, which senses the heat from the pilot flame. If the probe is cool, the device will prevent any gas flow unless manually lighting the pilot. See the full Fireplace and Lighting Information card attached to the fireplace or as reproduced in Appendix A of the Installation Manual.

Locating fireplace and lighting information

The Fireplace and Lighting Information card is located on a card under the firebox, below the end window, on end opposite the wall.

To access the card, remove the front and end barrier screens, and front sill (all held in place by magnets). See diagrams at right.

The card is located at the end of the unit. There is important information on both sides of the card. It must be left with the fireplace when you are done.

Locating info card

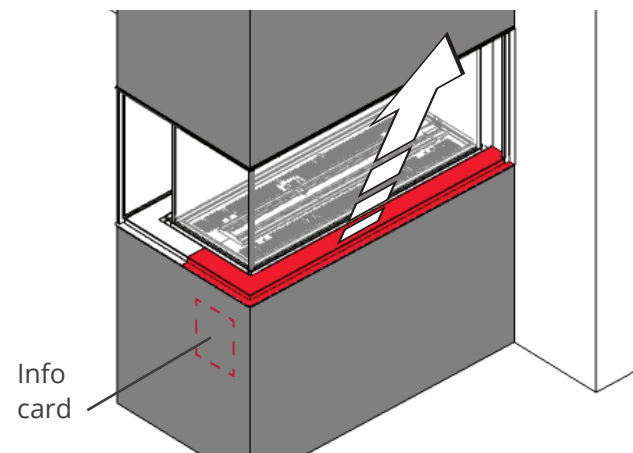
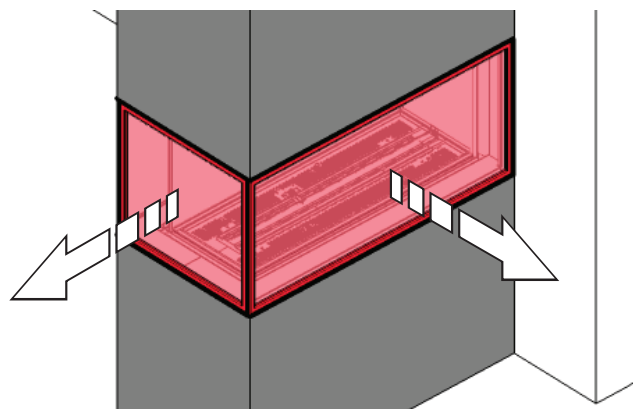
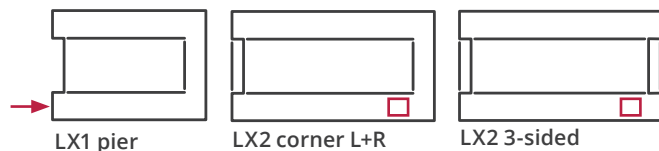

Fireplace model
Serial number

MILES INDUSTRIES LTD. NOTES: 1. 1-800-577-7979 (USA) 1-800-577-7979 (CANADA)		NET HEAT Max 24,000 Btu/hr Min 6,500 Btu/hr
MODEL/ MODÈLE 739MM	HEAT INPUT/ PUISSANCE P.C. (F) ALIMENTATION (GAS, LIQ.)	3.2"
SERIAL NO. 7320N 110000	HEAT INPUT/ PUISSANCE P.C. (F) ALIMENTATION (GAS, LIQ.)	5.0"
DIRECCION A - DIRECCION B - DIRECCION C (T) DIRECCION D - MILLES INDUSTRIES LTD. 1770 WINDY SPRING, 1170 WINDY SPRING, MISSISSAUGA, ONT. L4V 1V6 DIRECCION A - DIRECCION B - DIRECCION C (T) DIRECCION D - MILLES INDUSTRIES LTD. 1770 WINDY SPRING, 1170 WINDY SPRING, MISSISSAUGA, ONT. L4V 1V6	CAPACITAT/ CAPACITAT 750	750
<p>WARNING</p> <p>Do not attempt to access the card while the fireplace is hot! Let the fireplace cool first before touching it!</p>		<p>THIS FIREPLACE IS NOT TO BE USED FOR HEATING PURPOSES. NE PAS UTILISER CE FIRE PLACE POUR LE CHAUFFAGE. THIS FIREPLACE IS NOT TO BE USED FOR HEATING PURPOSES. NE PAS UTILISER CE FIRE PLACE POUR LE CHAUFFAGE.</p>
<p>NE PAS UTILISER CE FIRE PLACE POUR LE CHAUFFAGE. NE PAS UTILISER CE FIRE PLACE POUR LE CHAUFFAGE.</p>		<p>NE PAS UTILISER CE FIRE PLACE POUR LE CHAUFFAGE. NE PAS UTILISER CE FIRE PLACE POUR LE CHAUFFAGE.</p>
<p>NE PAS UTILISER CE FIRE PLACE POUR LE CHAUFFAGE. NE PAS UTILISER CE FIRE PLACE POUR LE CHAUFFAGE.</p>		<p>NE PAS UTILISER CE FIRE PLACE POUR LE CHAUFFAGE. NE PAS UTILISER CE FIRE PLACE POUR LE CHAUFFAGE.</p>
<p>NE PAS UTILISER CE FIRE PLACE POUR LE CHAUFFAGE. NE PAS UTILISER CE FIRE PLACE POUR LE CHAUFFAGE.</p>		<p>NE PAS UTILISER CE FIRE PLACE POUR LE CHAUFFAGE. NE PAS UTILISER CE FIRE PLACE POUR LE CHAUFFAGE.</p>

Parts of your fireplace

Here are the major components of your installed fireplace, with the protective barriers installed. Your individual fireplace may appear differently depending on your installed options.

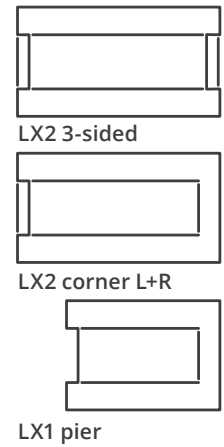
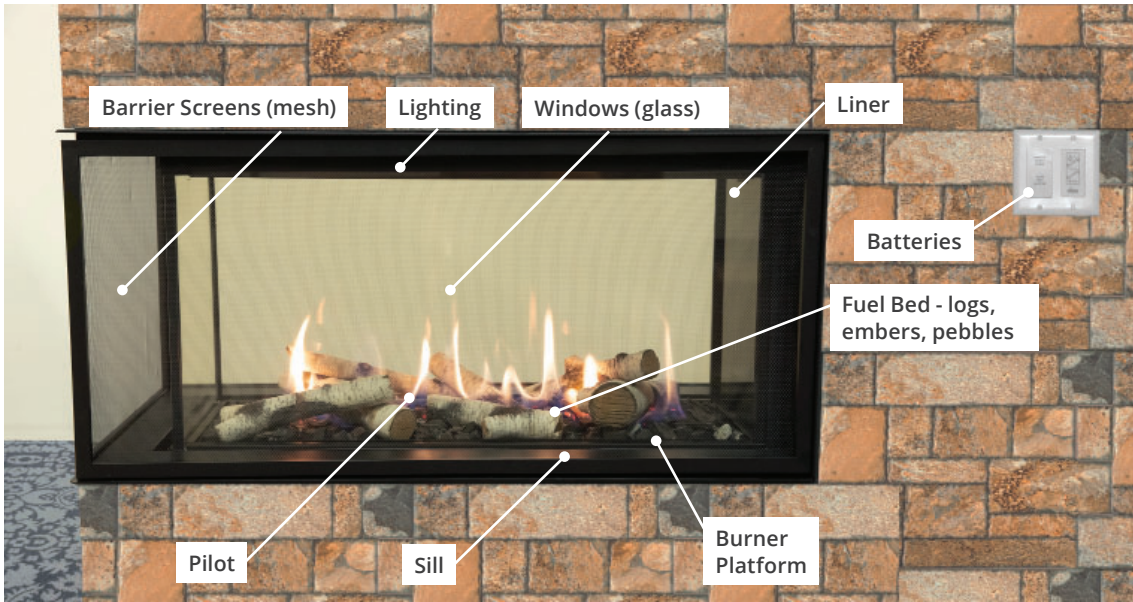

Here are the control components of your installed fireplace, with the barrier screens and one sill removed. Your individual fireplace may appear differently depending on your installed options.

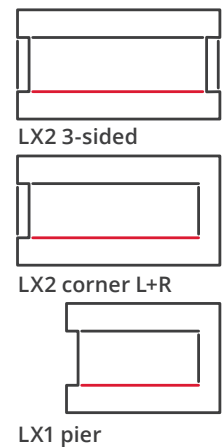
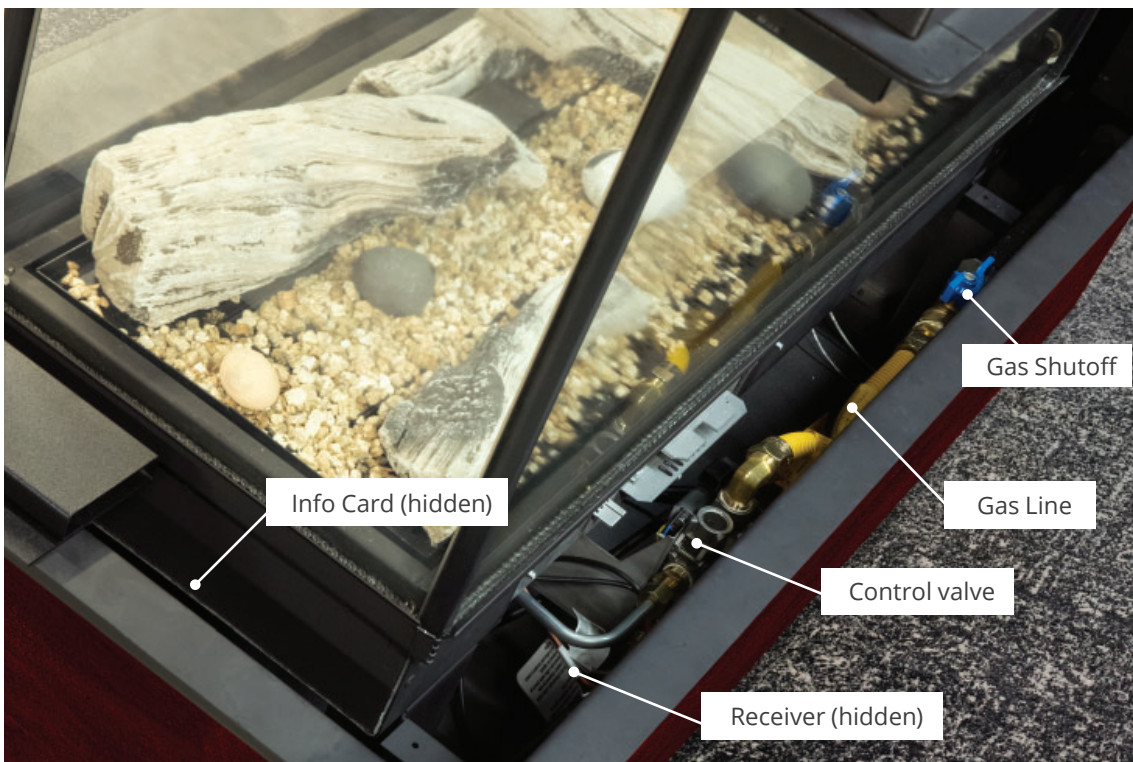

Operating your fireplace

Fireplace control devices

There are two ways to control your fireplace.

1. **Thermostatic Remote Control** turns fire and lights ON and OFF, controls flame height and can be programmed to function automatically.
2. **Wall Switch** turns fire ON and OFF, and controls flame height.

Remote Control



Wall Switch



Turn your fireplace ON



WARNING

STOP IF YOU SMELL GAS! DO NOT LIGHT!
See cover page immediately!

Press and hold:

- button on remote, or
 - ON-OFF button on wall switch
- until 8 short beeps confirm the start sequence has begun; release button.

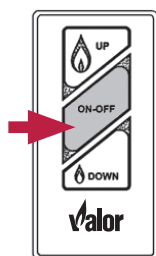

The pilot lights up, followed by the fireplace.

If you are using the handset, it displays a pilot flame symbol () during the ignition sequence.

If you need to light up the pilot manually, see the Fireplace and Lighting Information card attached to the fireplace - see page 7 to learn how to access it. Also, a copy of this card is reproduced in Appendix A of the Installation Manual.

Turn your fireplace OFF (including pilot)

Press and hold:

- button on remote, or
- ON-OFF button on wall switch

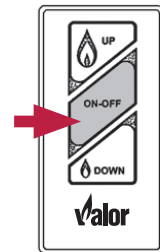

If the flames or pilot are on, they will go out and you will hear the valve motor wind down. You will hear a clunk and a beep indicating that the valve has received the signal from the remote control.

In the unlikely event that you cannot turn off your fireplace with the remote control handset, use the wall switch. If the wall switch malfunctions and will not turn off the fireplace, wait 3 hours and the fireplace will automatically go to pilot. You can then access the controls inside your fireplace, once it has cooled.



WARNING

Risk of severe burns! Surface of the fireplace are very hot during operation! Ensure fireplace has cooled off before accessing control.

Alternatively, you may turn off the house gas supply. In all cases, call your dealer for service assistance.



ON:
parallel
to pipe





OFF:
perpendicular
to pipe







To use additional functions of your Remote Control such as temperature or program settings, see "Appendix A-Remote control operation" on page 29 of this manual or visit valorfireplaces.com/remotes

Operating your fireplace

Turn on lights



Your fireplace comes with overhead lighting to highlight the beauty of the logs. To turn the lights on, press the  button on the remote. To turn them off, press the  button again.

To adjust the light level, press and hold the  button until the  symbol begins flashing on the remote. Then press and hold the  or  button. Press  or wait to confirm lighting level.



Child proofing your handset

Your remote control can be locked to prevent operation by children.

To turn child proofing ON:

1. Press and hold the  and  buttons simultaneously.
2.  is displayed on the handset screen making the handset inoperable, with the exception of the OFF function.

To turn child proofing OFF:

1. Press and hold the  and  buttons simultaneously.
2.  disappears from the handset screen and the handset is returned to full functionality.

Preventing inadvertent ignition

You can use one of the following two methods to ensure that your fireplace will not turn on unexpectedly.

- Under the front sill, shut off the local gas supply to the control valve. (See *Locating Info Card* on page 7 for details on how to access this area)

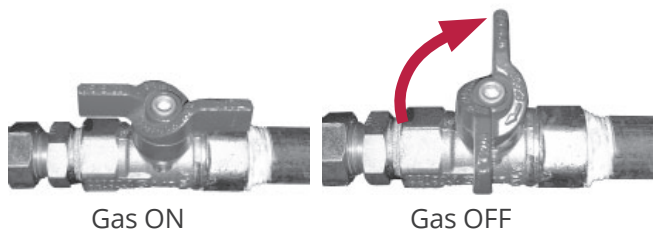
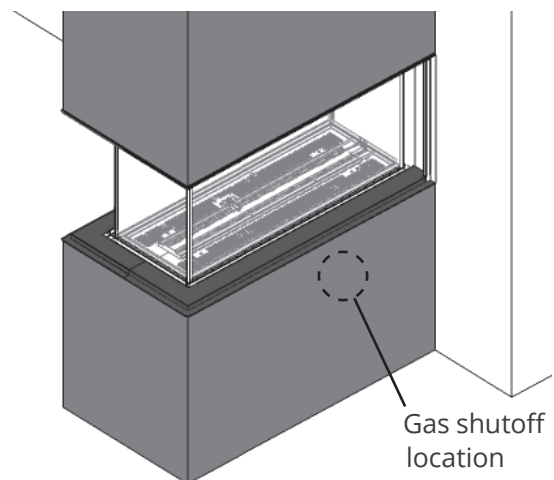
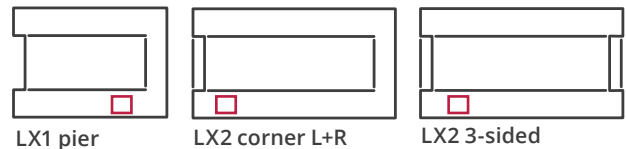

- Alternately, remove all batteries from the battery holder next to wall switch and the handset.

Automatic shut-off (in certain conditions)

Your fireplace's remote control is equipped with an automatic shut-off mechanism which is activated in certain conditions. See *Remote Control Operation* at Appendix A or valorfireplaces.com/remotes for a description of this feature.

Replacing batteries

WARNING

Do not attempt to access the batteries while the fireplace is hot! Let the fireplace cool first before touching it!

Caution

Do not use a screwdriver or other metallic object to remove the batteries from the battery holder or the handset! This could cause a short circuit.

Low battery signals:

- Handset: battery icon on display displays one lit bar.
- Holder: rapid series of beeps during use and operation.

BEFORE changing the batteries, turn the fireplace off (including pilot).

The fireplace uses four AA 1.5 V **alkaline** batteries in a separate battery holder located next to the wall switch and two AAA 1.5 V **alkaline** batteries in its handset. Batteries should last one to two seasons, depending on usage. Removing the batteries during the off-season will extend battery life.

The battery holder is located next to the wall switch behind a magnetic cover.

To replace the batteries:

1. Carefully pull the battery holder out of the wall switch panel.

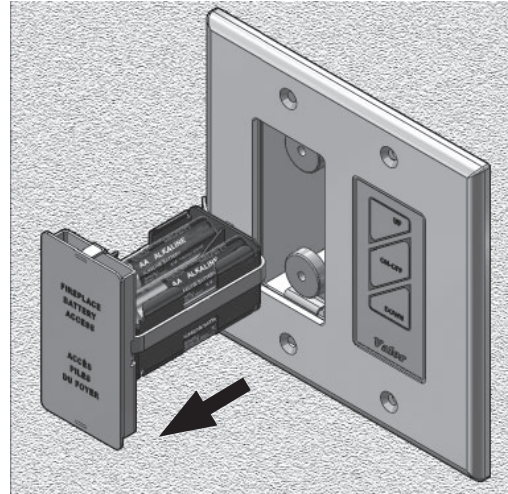

2. Remove the used batteries from the battery holder and replace with 4 new AA 1.5V **alkaline** batteries. **Do not mix new and used batteries.**
3. Reinsert the battery holder in the wall switch box snapping the magnetic cover in place.

Caution

Do not put batteries in the receiver as leaking acid could damage its circuit board.

4. Dispose of used batteries according to your local government hazardous waste requirements.

Using Handset Wall Holder

Your fireplace equipment includes a wall holder to store the handset. If it hasn't been installed, refer to the instructions in the fireplace Installation Manual.



Remote and wall holder

Replacing light bulbs

Lighting

This appliance is equipped with decorative lighting located above the fuel bed.

If any of the bulbs are out, replace them using the following steps.

Required Bulbs

The light bulbs in the fireplace are 120V, 20W bi-pin (JC) halogen bulbs GY6.35. A total of 4 are installed in the LX1 and 3 in the LX2 units.



Remove Barriers and Windows

Changing the light bulbs requires access to the inner firebox. See "Remove the windows for cleaning" on page 14 for details on removing the windows from the fireplace.



For the LX1, it is easiest to see and change the light bulbs opposite the window you are opening. You may find it easier to remove both front windows if bulbs on both side of the appliance need changing.

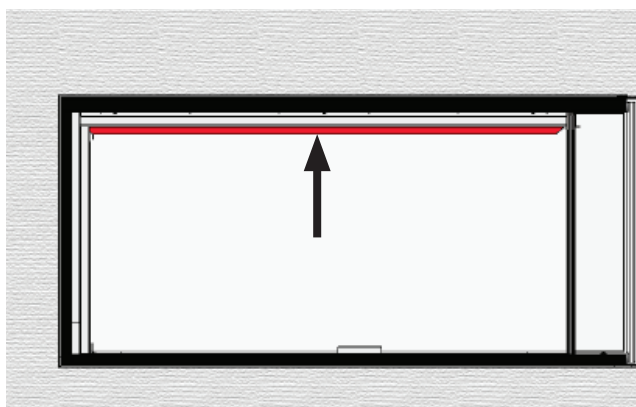

Lighting rail just behind window

LX1: on both sides

LX2 3-sided and corner units: in the front

Change Bulbs



Wear gloves when changing these bulbs. Most manufacturers recommend never touching them as oil from your skin can shorten their life.

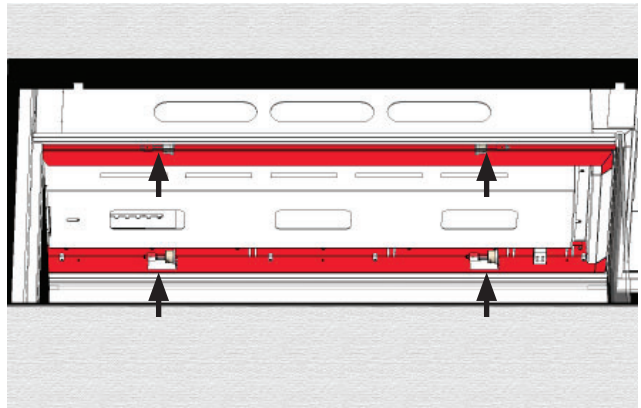

LX1: two rails of 2 bulbs each

Position of light bulbs looking up in the firebox

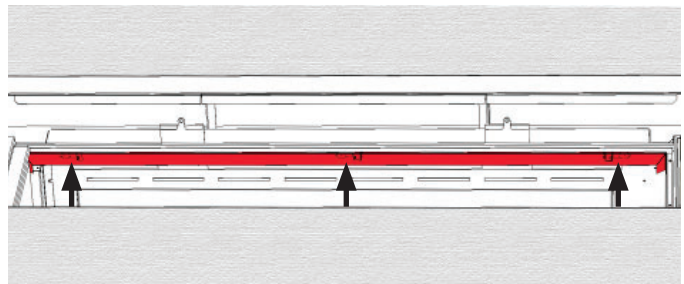

LX2 3-sided and corner units: one rail of 3 bulbs

Position of light bulbs looking up in the firebox

1. Gently pull the bulb out of the receptacle in the lighting rail.
2. Replace with a new bulb. Be careful to align pins with the receptacle holes.
3. Test the lighting with the remote control handset before replacing windows (lighting can operate independent of main fire being on or off)—see "Appendix A-Remote control operation" on page 26.
4. Reinstall windows and barrier screens following steps in "Refit the windows" pages 16 - 17.

Annual service and maintenance

We recommend having your fireplace serviced before initial use, and at least once per year by a qualified service technician. Contact your dealer quoting the model serial number, if possible. It will be helpful if the fireplace's serial number can also be quoted. These numbers are on the information card (see page 7).

A list of replacement parts is included in your fireplace Installation Manual. When requesting spare parts please quote the part number and description to ensure the correct part is ordered.

Annual Inspection

To ensure the optimal performance and safety of your fireplace, contact your dealer to have a qualified technician review and verify the list below at least once every year.

Safe Operation List: to be performed by a qualified technician only.

- Inspect and operate the pressure relief mechanism to verify relief mechanisms are free from obstruction to operate. See *"Cleaning your fireplace" pages 14-17.*
- Clean glass window with a suitable fireplace glass cleaner. Abrasive cleaners must not be used. Be careful not to scratch the glass when cleaning. See *"Cleaning glass mineral deposits" on page 15.*
- Inspect the operation of the flame safety system Pilot or Flame rectification device.
- Inspect and ensure the lighting of the main burner occurs within 4 seconds of the main gas valve opening. Visual inspection should match that outlined in the appliance instruction manual. Inspect primary air openings for blockage. See *"Checking pilot and burner flames" pages 18-19.*
- Inspect condition of vent and vent terminal for sooting or obstruction and correct if present.
- Vacuum and clean any excess debris in the firebox that is not supposed to be there.
- Test and measure the flame failure response time of the flame safety system. It must de-energize the safety shut-off in less than 30 seconds.
- Check all accessible gas-carrying tubes, connections, pipes and other components for leaks. See *Set up Gas Supply* section of the fireplace Installation Manual.
- Replace any burnt out light bulbs in the lighting tracks. See *Replacing Light Bulbs* in the Installation Manual.



Caution

Label all wires prior to disconnection when servicing controls. Wiring errors can cause improper and dangerous operation.

Verify proper operation after servicing.

Cleaning your fireplace

WARNING

Risk of severe burns! Surfaces of the fireplace are very hot during operation. Ensure fireplace has cooled off before touching it.

Remove the windows for cleaning

1. Remove all three barrier screens by pulling on them (They are magnetic, so no tools required).

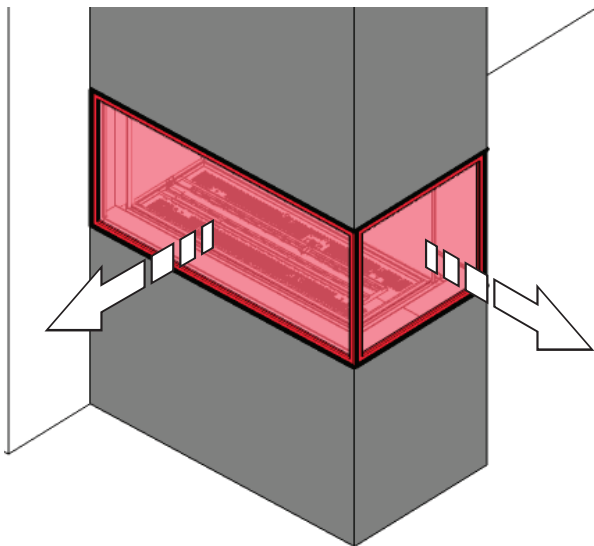

2. Remove the Hot Glass Warning plate.

! WARNING: EXTREMELY HOT GLASS AND FIREPLACE
 Risk of severe burns. Keep Children away from fireplace & controls.
AVERTISSEMENT : VITRE ET FOYER EXTRÊMEMENT CHAUDS
 Risque de brûlures graves. Tenez les enfants à l'écart du foyer et de ses commandes.

3. Locate the window retainer hooks.

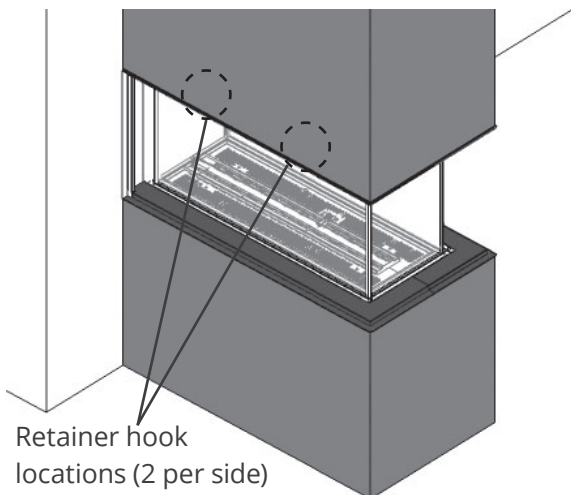

4. Hook the window handle to one of the spring loaded window levers.



5. Pull the window retainer hooks out and up from the railing at the top of the side windows.

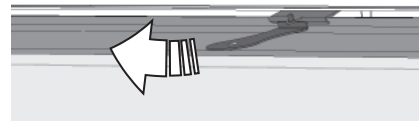

6. Pull the top of the window out and up into the gap between the firebox and outside of the fireplace. (Note the sills have been removed from this image for clarity, but you do not need to remove them to pull the window out).

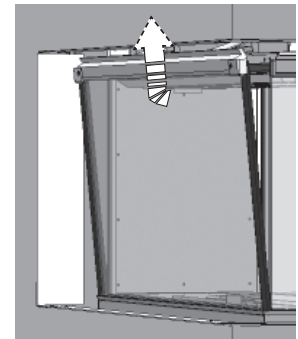

7. Pull the bottom edge out and down.

8. Repeat steps 4-6 for the other side window.

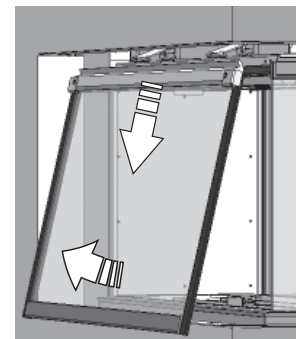

Cleaning your fireplace

Cleaning glass mineral deposits



WARNING

Risk of severe burns! The glass windows are very hot during operation. Ensure the fireplace and glass have cooled off before touching them.

A by-product of the combustion process in a gas fireplace is a mineral which can appear as a white film on the ceramic glass windows of your appliance.

The composition of the deposit varies depending on location and time, and can appear intermittently.

There is no definitive solution to this issue. Various cleaning products have been tried with varying results. The following are recommendations only and cannot guarantee results.

Note: Mineral deposits occur naturally and are not covered under the Valor® warranty.

- Clean the glass regularly to avoid a buildup of film from mineral. If the film is left for a long period of time, it can etch the glass, making it much harder, if not impossible, to remove.
- Never use an abrasive cleaner or ammonia-based cleaner on the ceramic glass. Any abrasion of the surface can compromise the strength of the glass. An emulsion-type cleaner is recommended.
- Use a soft damp cloth to apply the cleaner. Dry the glass with a soft, dry, preferably cotton cloth. Most paper towels and synthetic materials are abrasive

to ceramic glass and should be avoided. Follow all instructions on the bottle/container.

- Our dealers have experienced good results from the products listed below. We cannot, however, guarantee results of these products.
 - » Brasso, Polish Plus by KelKem, Cook Top Clean Creme by Elco, White Off by Rutland, Turtle Wax

Do not clean the glass while it is hot

- Always securely replace the windows and the barrier screen before lighting (see next page).
- If broken, glass panes may only be replaced as a complete window unit as supplied by the manufacturer.
- If the barrier screen becomes damaged, it must only be replaced with the same model and version barrier from Valor.

Cleaning other parts

- Clean the steel trims with mild soap and warm water. Any alcohol/solvent-based cleaner may weaken and damage the coating.
- Clean the barrier screens by dusting with a soft brush.
- Clean the firebox ceramic logs/rocks and walls by dusting them with a soft brush. Dust can also be removed from the burner using a soft brush after removing the ceramic logs. When cleaning, make sure that no particles are brushed into the slots of the burner.



Caution

Choking Hazard! Make sure the fireplace area is clear of firebed small particles to avoid ingestion by small children. Vacuum thoroughly around the fireplace area after cleaning.

Cleaning your fireplace

Log position

Log position is important in your Valor fireplace because it can optimize the beauty of the flame and the combustion efficiency of your fireplace.

If logs are moved during glass cleaning or other fireplace maintenance, refer to your fireplace Installation Manual for specific instructions on how to position them for optimal operation. If you are not comfortable performing this maintenance, please contact your dealer.

Clear pilot safe zone

There is a protected zone in front of the pilot light, bordered by a shallow steel barrier, to allow the pilot light to ignite the main burner. Ensure that it remains clear of embers to allow for proper lighting.

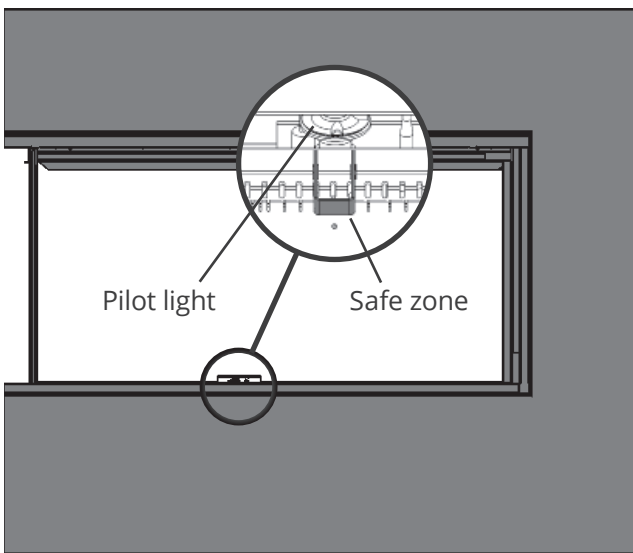

Refit the windows

1. Remove any fuel bed media from the window bottom rail before installing the window.
2. Ensure the braided gasket is well fitted to the bottom of the window.
3. Insert the window behind the front panel of the appliance. Ensure the angled rail is facing out.
4. Lower the bottom of the window into the bottom rail.

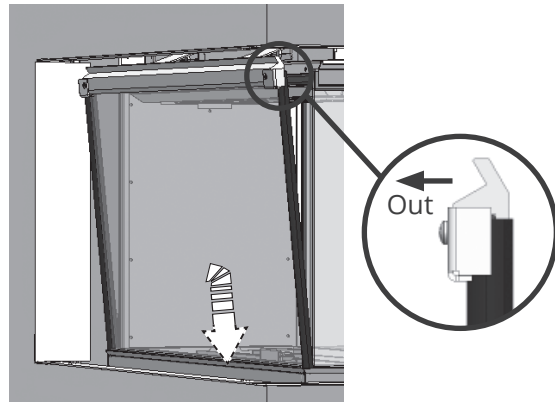

5. Push the top of the window pane against the firebox. Ensure it is centered on the firebox so it seals properly against the end window.

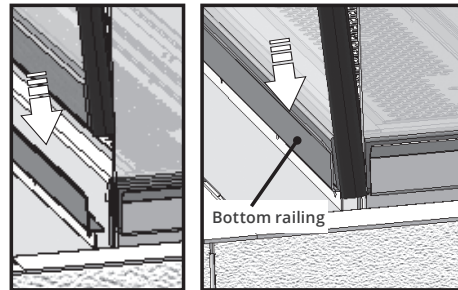

Cleaning your fireplace

- Pull one retainer hook over the angled rail at the top of the window, and hook it down completely. Repeat on the other side. Ensure the hooks latch completely to the rail.

Correct



Incorrect

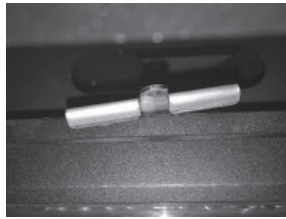

- Press firmly around the edge of the window with your hands, particularly at the top and on each side. The silicone gaskets must seal the window from top to bottom.
- Repeat steps 1 to 7 for the other side window.
- Replace the hot glass warning plate against one of the side windows, in the bottom rail.

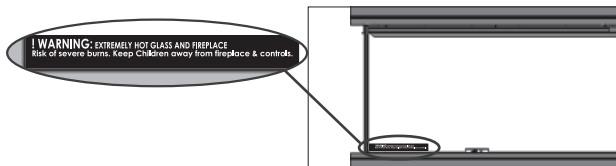

- Replace barrier screens on fireplace.

! WARNING

For safety purposes, make sure the barrier screen is re-installed on the fireplace front after maintenance.

! WARNING

The window units must be correctly installed, fastened and sealed after servicing. If not it could result in serious bodily injury and/or damage to the fireplace.

To ensure safe operation:

- Double-check that the bottom of each window frame is correctly installed in the bottom support railing;
- Verify that the retainer hooks are properly fastened to the top angle brackets;
- Pull out the top of each side window and release it to ensure the springs return it;
- Ensure the window is sealed before operation.

! WARNING

Failure to install the window correctly can:

- Cause carbon monoxide to leak.
- Affect the performance of the fireplace.
- Damage components.
- Cause overheating resulting in dangerous conditions.

Damage caused by incorrect window installation is not covered by the Valor Warranty.

Checking pilot and burner flames

The pilot light and burner flames should be checked periodically. Check after the fire has been on for at least 30 minutes. The pilot flame must cover the tip of the thermocouple probe. The main burner flame pattern will vary depending on the type of installation and climatic conditions.

Performance of propane gas fireplaces may be affected by the quality of commercial gas supplied in your area.

The fireplace area must always be kept clear and free from combustible materials, gasoline and other flammable vapors and liquids.

Inspect the vent terminal outdoors regularly to ensure that it is not obstructed by snow, trees, bushes, leaves, or other objects. We recommend at least an annual inspection.

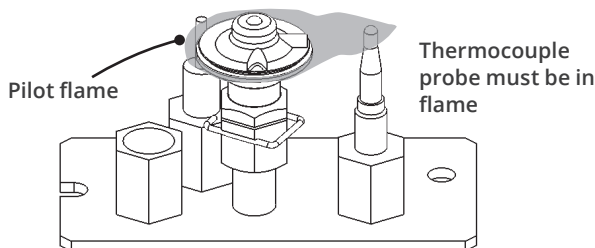

Note

The height and color of your flames can vary depending on fuel type, fuel quality and mixture, altitude, and aeration adjustment at or after installation.

The photos of typical flame appearance are for illustrative purposes only. Your fireplace may be operating normally but appear different than the photos.

Venting configuration, elevation, burner aeration setting and local fuel heating value can all affect flame appearance.

Typical flame appearance - LX1

Birch log kit



Driftwood log kit

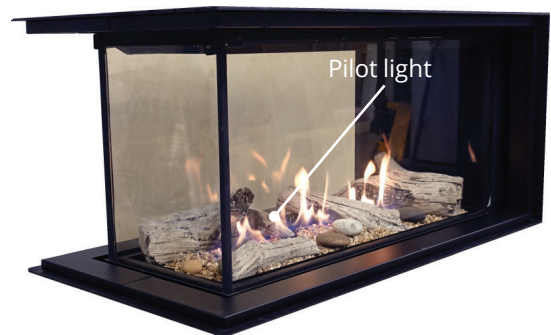

Decorative Murano Glass kit



Rock and Shale kit



Checking pilot and burner flames

Typical flame appearance - LX2

Driftwood log kit



Decorative Murano Glass kit



Splitwood kit



Rock & Shale kit



Birch Log kit



Note

The height and color of your flames can depend upon many variables, including fuel type, fuel quality, fuel mixture, altitude, and aeration adjustment at or after installation.

The photos of typical flame appearance are for illustrative purposes only. Your fireplace may be operating normally but appear different than the photos.

Venting configuration, elevation, burner aeration setting and local fuel heating value can all affect flame appearance.

Frequently asked questions

Question	Answer
<p>What if my fireplace won't turn on?</p>	<p>If you have followed all instructions for your remote control or wall switch (see page 9, pages 24-30 or page 31) and your fireplace still won't turn on, the batteries located inside the wall switch kit may be low and need replacing. See page 11 for instructions on how to replace the batteries.</p> <p>If the fireplace still won't turn on after that, call your dealer for further information. Your fireplace may require service by a qualified service technician. Visit valorfireplaces.com/contact for a list of dealers near you.</p>
<p>I've just started my fireplace for the first time, what is that smell?</p>	<p>When operating your fireplace for the first time, some vapors may be released due to the burning of curing compounds used during manufacturing. They may cause a slight odor and could cause the flames to be the full height of the firebox, or even slightly higher, for the first few hours of operation. This is perfectly normal. See <i>First Time Operation</i> on page 7 for more information.</p>
<p>When I operate the fireplace, why do I suddenly hear a faster series of beeps than usual?</p>	<p>This is an indication that the batteries in your fireplace are getting critically low (not the batteries in your remote control handset, but the batteries in the battery holder beside the wall switch). See page 11 for instructions on how to replace the batteries.</p>
<p>Why do I hear popping or snapping noises?</p>	<p>As your fireplace heats and cools with normal use, its metal parts will expand and contract, which may cause some noise. This is perfectly normal.</p>
<p>Why do I hear whirring noises?</p>	<p>As you start or adjust your fireplace's flame, the control valve motor turns to adjust the settings. This is perfectly normal.</p>
<p>How do I clean my fireplace?</p>	<p>See "Cleaning your fireplace" pages 14-17 for cleaning instructions to keep your fireplace looking great.</p>
<p>I dropped some pieces of embers under the fireplace while cleaning, is this dangerous?</p>	<p>No. The embers from the fuel bed are not flammable and will not impact the operation of your fireplace. If this happens, vacuum them up when you clean your fireplace.</p>
<p>There is condensation on the inside of the glass, is this okay?</p>	<p>This is normal when the fireplace first turns on, and will disappear naturally when the fireplace heats up.</p>
<p>There is a white film on the inside of the glass, is this okay?</p>	<p>This happens due to composition of the gas from your supplier. A by-product of the combustion process in a gas fireplace is a mineral which can appear as a white film on the ceramic glass window of your appliance. Clean as soon as possible (when the fireplace is cool) so it does not bake onto the glass with time and become permanent. See page 14 to page 17 for cleaning instructions.</p>

Frequently asked questions

Question	Answer
When I start my fireplace, the flame is blue or transparent, is this normal?	This is normal, your flame will take on a more yellow/orange appearance as the fireplace heats up.
When I start my fireplace, the flame is dirty or black, is this normal?	No. This is possibly caused by a blocked opening in the burner which can be cleaned by vacuuming it. See page 14 to page 17 for cleaning instructions, and call your dealer if the problem persists after cleaning.
After running for some time, my fireplace has soot gathering on the logs, panels, or roof, is this normal?	Minor amount of soot developing on logs is common, but soot that builds up, falls off, and accumulates indicates the burner needs adjustment, or the logs may have been installed incorrectly. Contact your dealer for remedies to excessive sooting.
Where can I purchase parts for my fireplace?	Any of our Valor dealers are able to order parts or provide field service. Please contact your dealer - see page 3 - or visit valorfireplaces.com/contact for a list of dealers near you.
Who can service my fireplace?	We recommend having your fireplace serviced before initial use, and at least once every year by a qualified service technician. Contact our dealer, quoting the model and serial numbers, if possible. These numbers can be found on the fireplace information card attached to the fireplace - see page 7.
Why does my pilot light go out when I leave the house for extended periods of time?	Your fireplace has a built-in safety shutoff. If the flame height does not adjust for 7 days, the fireplace will automatically turn the pilot off, and would need to be turned on again using either the handset or wall switch.
Why doesn't the fireplace turn down when it goes above the temperature I've set?	Rather than constantly turning your fireplace up and down, the temperature feature of your remote control is designed to efficiently give you a smooth maintenance of a comfortable temperature. With this you may find temperature fluctuations beyond the set point to varying degrees, depending on installation and room size.

Valor® warranty

If you have a problem with this unit, please contact your dealer or supplier immediately. Under no circumstances should you attempt to service the unit in any way by yourself. The warranties in paragraphs 1 and 2 are provided only to the initial user of this unit, are not transferable and are subject to the conditions and limitations in paragraphs 3, 4 and 5. Please review the conditions and limitations carefully and strictly follow their requirements.

1. Extended Warranty Coverage

For a period of up to ten (10) years, Miles Industries Ltd., (the “Company”) or its appointed distributor will at its option pay the initial owner for the repair of, or will exchange the following parts or components which are found to be defective in material or workmanship under normal conditions of use and service:

Maximum Warranty Period		10 years
Part or Component	Defect Covered	
Exterior steel casing	Corrosion	✓
Glass	Loss of structural integrity	✓
Cast iron parts	Corrosion	✓
Firebox and heat exchanger	Corrosion (but not discoloration) causing loss of structural integrity	✓

2. Two-Year Parts Warranty

In addition, for two (2) years from the date of purchase, the Company, at its option, will repair or exchange all parts and components not listed above but that are found to have a bona fide defect in material or workmanship under normal conditions of use.

3. Conditions and Limitations

- The warranty registration card must be completed by the initial owner and returned to the company within 90 days. Alternatively, the warranty registration form may be filled out online at www.valorfireplaces.com
- Installation and maintenance must be performed by an authorized and trained dealer in accordance with the Company's installation instructions.
- This warranty is void where installation of the unit does not conform to all applicable codes including national and local gas appliance installation codes and building and fire codes.
- The owner must comply with all operating instructions.
- The Company is not responsible for the labor costs to remove defective parts or re-install repaired or replacement parts.
- The initial owner of the unit will be responsible for any shipping charges for replacement parts as well as travel time incurred by the dealer to perform the warranty work.

- This warranty applies to non-commercial use and service and is void if it is apparent that there is abuse, misuse, alteration, improper installation, accident or lack of maintenance to the unit.
- The warranty does not cover damage to the unit through:
 - Improper installation, operational or environmental conditions.
 - Inadequate ventilation in the area or competition for air from other household equipment or appliances.
 - Chemicals, dampness, condensation, or sulphur in the fuel supply lines which exceeds industry standards.
- This warranty does not cover glass, log breakage or damage to the unit while in transit.
- The Company does not allow anyone to extend, alter or modify this warranty and assumes no responsibility for direct, indirect or consequential damages caused by the unit. State or provincial laws where the initial user or user resides may provide specific rights extending this warranty and, if so, the Company's sole obligation under this warranty is to provide labor and/or materials in accordance with those laws.

4. Discharge of Liability

After two (2) years from the date of purchase, the Company may, at its option, fully discharge all obligations under this warranty by paying to the first owner the wholesale price of, or replacing, any defective parts.

5. No Other Warranty

All obligations to repair this unit are defined in this warranty. Some states or provinces may specifically mandate additional obligations on the part of manufacturers, but in the absence of such specific legislation, there is no other warranty or obligation expressed or implied.

Valor® outdoor installation warranty

If you have a problem with this unit, please contact your dealer or supplier immediately. Under no circumstances should you attempt to service the unit in any way by yourself. The warranties in paragraphs 1 are provided only to the initial owner of this unit, are not transferable and are subject to the conditions and limitations in paragraphs 2 and 3. Please review the conditions and limitations carefully and strictly follow their requirements.

1. Two-Year Parts Warranty

Two (2) years from the date of purchase, the Company, at its option, will repair or exchange all parts and components that are found to have a bona fide defect in material or workmanship under normal conditions of use.

2. Conditions and Limitations

- a) The warranty registration card must be completed by the initial owner and returned to the company within 90 days. Alternatively, the warranty registration form may be filled out online at valorfireplaces.com
- b) Installation and maintenance must be performed by an authorized and trained dealer in accordance with the Company's installation instructions.
- c) This warranty is void where installation of the unit does not conform to all applicable codes, including national and local gas appliance installation codes and building and fire codes.
- d) The owner must comply with all operating instructions.
- e) The Company is not responsible for the labor costs to remove defective parts or re-install repaired or replacement parts.
- f) The initial owner of the unit will be responsible for any shipping charges for replacement parts as well as travel time incurred by the dealer to perform the warranty work.
- g) This warranty applies to non-commercial use and service and is void if it is apparent that there is abuse, misuse, alteration, improper installation, accident or lack of maintenance to the unit.
- h) This warranty does not cover damage to the unit due to:
 - i) Improper installation, operational or environmental conditions.
 - ii) Inadequate ventilation in the area or competition for air from other household equipment or appliances.
 - iii) Damage due to chemicals, dampness, condensation, or sulphur in the fuel supply lines which exceeds industry standards.
- i) This warranty does not cover glass, log breakage or damage to the unit while in transit.
- j) The Company does not allow anyone to extend, alter or modify this warranty and assumes no responsibility for direct, indirect or consequential damages caused by the unit. State or provincial laws where the initial owner or user resides may provide specific rights extending this warranty and, if so, the Company's sole obligation under this warranty is to provide labor and/or materials in accordance with those laws.

3. No Other Warranty

All obligations to repair this unit are defined in this warranty. Some states or provinces may specifically mandate additional obligations on the part of manufacturers, but in the absence of such specific legislation, there is no other warranty or obligation expressed or implied.

Appendix A-Remote control operation

Remote Control Operation

Note: Before using the remote control system for the first time, the receiver and the handset must be paired. See the *Remote Control Initial Pairing* section in the Installation Manual.

Main Display

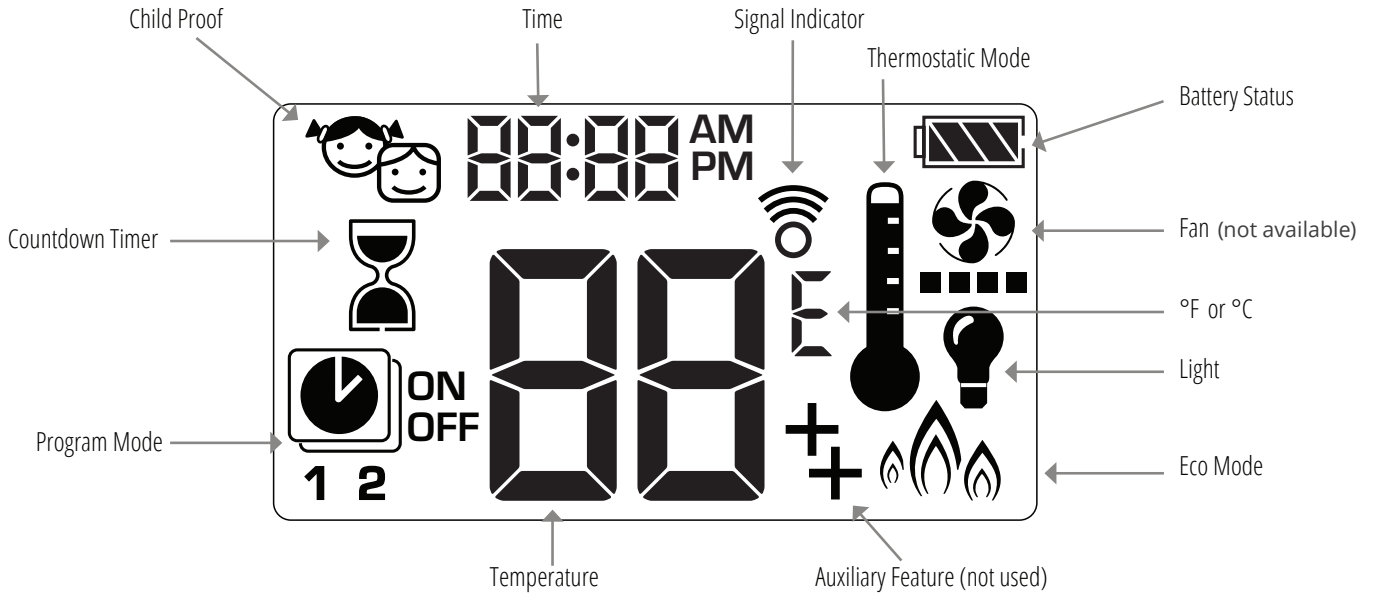

To Turn On Fire

NOTE: When pilot ignition is confirmed, motor automatically turns to maximum flame height.

One-Button lighting (default):

Two-Button lighting: + simultaneously

Press and hold for 4 seconds, until 8 short beeps and a blinking series of lines confirms the start sequence has begun. Release button.

Main gas flows once pilot ignition is confirmed.

Handset automatically goes into manual mode after main burner ignition.

Standby Mode (Pilot Flame)

Press and hold to set appliance to pilot flame.

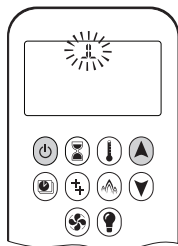
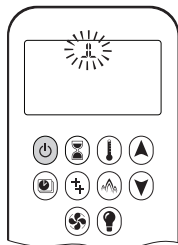

CAUTION: If the pilot does not stay lit after several tries call your local service technician or gas supplier.

To Turn Off Fire

Press to turn OFF.

Note: There is a 2 minute delay after switching off before the next ignition is possible.

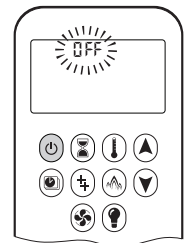

CAUTION: Always check the fire and pilot visually to ensure they are off.

Flame Height Adjustment

To increase flame height, press and hold .

To decrease flame height, press and hold . You may hold the button down until the fire is set to pilot flame only.

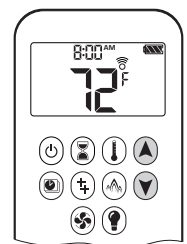



Appendix A-Remote control operation

Designated Low Fire and High Fire

To go to low fire, double-click . "LO" is displayed.

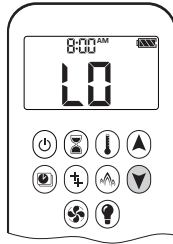
Note: Flame goes to high fire first before going to low fire.



To go to high fire, double-click . "HI" is displayed.



Choosing 1-Button or 2-Button Ignition

On the remote control handset, you can choose a 1-button or 2-button ignition. You can also choose to activate or deactivate some of the functions. By default, the handset is set to a 1-button ignition.

To change from 1-button to 2-button ignition, remove the batteries, wait 10 seconds, reinsert batteries, and immediately when the display flashes, press and hold the  button for 10 seconds. **ON** is displayed and **1** is flashing. When change is complete, **1** changes to **2**.

To change from 2-button to 1-button ignition, proceed the same as above. **ON** is displayed and **2** is flashing. When change is complete, **2** changes to **1**.

Deactivating or Activating Functions

These functions are active by default, but can be deactivated at any time:

- Child Proof
- Program Mode
- Thermostatic Mode
- Eco Mode
- Circulating Fan Operation
- Countdown Timer

To deactivate functions:



1. Install batteries. All icons are displayed and flashing.
2. While the icons are flashing, press the relevant function button and hold for 10 seconds.
3. The function icon will flash until deactivation is complete. Deactivation is complete when the function icon and two horizontal bars () are displayed.

Note: If a deactivated button is pressed, there is no function, and the two horizontal bars are displayed.

To activate functions:

1. Install batteries. All icons are displayed and flashing.
2. While the icons are flashing, press the relevant function button and hold for 10 seconds.
3. The function icon will continue to flash until activation is complete, and then turn solid. Activation is complete when the function icon is displayed.















Setting Celsius or Fahrenheit

To change between °C and °F, press and hold  +  simultaneously.

Note : °C = 24-hour clock
°F = 12-hour clock



Setting the Time

1. Press  +  simultaneously. **Day** flashes.
2. Press  +  to select a number to correspond with the day of the week.
 - 1 = Monday
 - 2 = Tuesday
 - 3 = Wednesday
 - 4 = Thursday
 - 5 = Friday
 - 6 = Saturday
 - 7 = Sunday
3. Press  +  simultaneously. **Hour** flashes.
4. To select hour press  or .
5. Press  +  simultaneously. **Minutes** flash.
6. To select minutes press  or .
7. To confirm, press  +  simultaneously or wait.

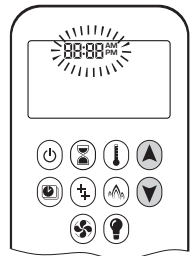

Appendix A-Remote control operation

Child Proof

Your handset can be set to lock out all commands to the fireplace, except OFF.

To turn Child Proof ON:

1. Press and hold (⏻) + (⏮) simultaneously.
2. (👤) is displayed. Child Proof is now active.

To turn Child Proof OFF:

1. Press and hold (⏻) + (⏮) simultaneously.
2. (👤) disappears. Child Proof is now inactive, and the handset has full function.

Countdown Timer

You can set your fireplace to automatically turn off at the end of a timer.

To set a Countdown Timer:

1. Press and hold (🕒) until (🕒) is displayed.
Hour flashes.
2. Press (▲) or (▼) to select Hour.
3. To confirm, press (🕒).
Minutes flash.
4. Press (▲) or (▼) to select Minutes.
5. To confirm, press (🕒) or wait.

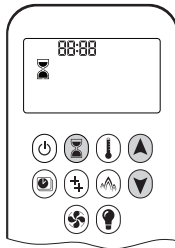

To turn off a Countdown Timer:

1. Press (🕒), and the (🕒) countdown disappears.

Note: The Countdown Timer only works in Manual, Thermostatic, and Eco modes. Maximum countdown time is 9 hours and 50 minutes.

Light/Dimmer Operation

On:

Press (💡), (💡) is displayed. Light is on at preset level.

Off:

Press (💡), (💡) disappears. Light turns off.

Setting:

1. Press and hold (💡) until (💡) flashes.
2. To adjust light between 20-100% press (▲) or (▼).
3. To confirm setting either press (💡) or wait.
(💡) is displayed.

Note: The light works independently of the pilot flame. If you want the light on but no flame, press (💡) button.

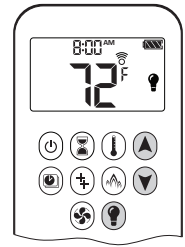

Appendix A-Remote control operation

Modes of Operation

Thermostatic Mode

The room temperature is measured and compared to the set temperature. The flame height is automatically adjusted to achieve the set temperature.



Program Mode

The temperature is controlled by Programs 1 and 2, each of which can be set to go on and off at specific times, at a set temperature.



Eco Mode

Flame height modulates between high and low. If the room temperature is lower than the set temperature, the flame height stays on high for a longer period of time. If the room temperature is higher than the set temperature, the flame height stays on low for a longer period of time. One cycle lasts approximately 20 minutes.





 If any of the above modes (Thermostatic, Program, or Eco) are engaged by the MyFire app over WiFi, the handset will display **APP**.

Manual Mode

The on/off status of the fireplace, as well as flame height, are manually controlled by the user.





Thermostatic Mode

On:

Press .  is displayed. Preset temperature displays briefly, followed by the room temperature.







Setting Desired Temperature:

1. Press and hold  until  is displayed and set temperature flashes.
2. To adjust set temperature, press  or .
3. To confirm, press  or wait.



Off:

1. Press .
2. Press  or  to go to Manual Mode.
3. Press  to go to Program Mode.
4. Press  to go to Eco Mode.





Program Mode

On:

Press . , 1 or 2, ON or OFF are displayed.



Off:

1. Press , , or  to go to Manual Mode.
2. Press  to go to Thermostatic Mode.
3. Press  to go to Eco Mode.







Note: The set temperature for Thermostatic Mode is the temperature for the ON time in Program Mode. Changing the Thermostatic Mode set temperature also changes the ON time temperature in Program Mode.

Default Settings:

- ON TIME (Thermostatic) TEMPERATURE: 70°F / 21°C
- OFF TIME TEMPERATURE: "— —" (pilot flame only)

Appendix A-Remote control operation

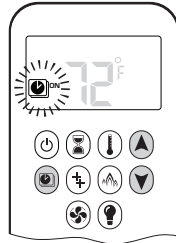

Temperature Setting:

1. Press and hold  until  flashes. **ON** and set temperature (set in Thermostatic Mode) is displayed.
2. To continue, press  or wait.  **OFF** displayed, temperature flashes.
3. Select off temperature by pressing  or .
4. To confirm, press .



Note: The on (Thermostatic) and off set temperatures are the same for each day.





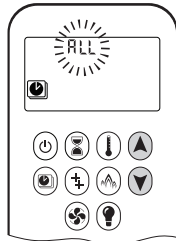



Day Setting:

1. **ALL** flashes. Press  or  to choose between:
 - **ALL** = same settings ON-OFF every day
 - **SA:SU** = same settings ON-OFF Saturday and Sunday
 - **1, 2, 3, 4, 5, 6, 7** = daily timer—unique ON-OFF settings for a single day of the week, for multiple days of the week or for every day of the week.
2. To confirm, press .









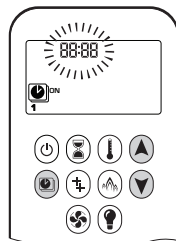

ALL Selected (same settings every day)

On Time Setting (PROGRAM 1)

1. , **1**, **ON** are displayed. **ALL** is displayed briefly. Hour flashes.
2. To select hour, press  or .
3. To confirm, press , , **1**, **ON** are displayed. **ALL** displayed briefly. Minutes flash.
4. To select minutes, press  or .
5. To confirm, press .



Off Time Setting (PROGRAM 1)

1. , **1**, **OFF** are displayed. **ALL** is displayed briefly. Hour flashes.
2. To select hour, press  or .
3. To confirm, press , , **1**, **OFF** are displayed. **ALL** displayed briefly. Minutes flash.
4. To select minutes, press  or .
5. To confirm, press .

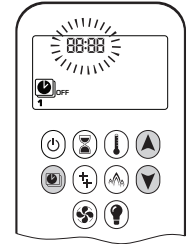

Note: Either continue to PROGRAM 2 and set ON and OFF times or stop programming at this point, and PROGRAM 2 remains deactivated.

Note: PROGRAM 1 and 2 use the same ON (Thermostatic) and OFF temperatures. Once a new ON (Thermostatic) and/or OFF temperature has been set, that temperature becomes the new default setting.

Note: ON and OFF times programmed for PROGRAM 1 and PROGRAM 2 become the new default times.



The batteries must be removed to clear the PROGRAM 1 and PROGRAM 2 ON and OFF times and temperatures.

SA:SU (same settings Saturday and Sunday) or 1, 2, 3, 4, 5, 6, 7 (different settings on different days)

- Set on time and off time using the same procedure as "ALL Selected" above.
- Waiting to finish setting.

Eco Mode

On:

Press  button to enter Eco Mode.  is displayed.

Flame height modulates between high and low every 20 minutes.

Off:

Press  button to exit Eco Mode.  disappears.



Appendix A-Remote control operation

Low Battery Indication

 **CAUTION:** Do not use a screwdriver or other metallic object to remove the batteries from the battery holder or the handset. This could cause a short circuit.

Handset

The battery icon  will show when the battery needs to be replaced. Replace with two 1.5 V AAA alkaline batteries.

Receiver

Frequent beeps for 3 seconds when the motor turns indicate the batteries in the battery holder need to be replaced. Replace with four 1.5 V AA alkaline batteries.

Automatic Shut Off

Countdown Timer

At the end of countdown time period, the fire turns off. The Countdown Timer only works in Manual, Thermostatic, and Eco Modes. Maximum countdown time is 9 hours and 50 minutes.

Low Battery Receiver

With low battery power in the battery holder, the system shuts off the fire completely. (This will not happen if the power is completely interrupted.)

Seven Day Shut Off

The system shuts off the fire completely if there is no change in flame height for 7 days.

Automatic Turn Down



3 Hour No Communication Function

The valve will turn to pilot flame if there is no communication between the handset and receiver for a 3-hour period. The fire will continue to function normally when communication is restored.

Appendix A-Remote control operation

Error Codes

In the event of an error condition with the handset or fireplace, the handset will display an error code.

Failure Code	Message on Handset	Duration of Display	Symptom	Possible Cause
F04	F04	4 sec	<ul style="list-style-type: none"> No pilot flame within 30 sec Note: after 3 failed ignition sequences, F06 shown 	<ul style="list-style-type: none"> No gas supply Air in pilot supply line No spark Reversed polarity in thermocouple wiring
F06	F06	4 sec	<ul style="list-style-type: none"> 3 failed ignition sequences in 5 minutes Fire is not responding, no pilot flame 	<ul style="list-style-type: none"> No gas supply Air in pilot supply line No spark Reversed polarity in thermocouple wiring Incorrect pilot orifice if valve has been converted from LPG to NG or vice versa
F07	Low battery symbol 	Permanent	<ul style="list-style-type: none"> Battery icon flashes on handset display 	<ul style="list-style-type: none"> Low battery in handset
F09	F09	4 sec	<ul style="list-style-type: none"> Fire is not responding No electronic control of fire 	<ul style="list-style-type: none"> Down arrow button  was not pressed during pairing Receiver and handset are not synced
F46	F46	4 sec	<ul style="list-style-type: none"> Fire is not responding Intermittent response No electronic control of fire 	<ul style="list-style-type: none"> No or bad connection between receiver and handset No power at receiver (batteries low) Low communication range (mains adapter faulty, handset not communicating with receiver)

Appendix B-Wall switch operation

The Wall Switch can be used to control your fireplace. You can turn the pilot on or off and you can increase or decrease the flame height.

Note that the thermostat and programming functions are not available with the wall switch.

Turning Appliance ON and OFF

Press ON-OFF button once to light pilot. Press again to shut off pilot.

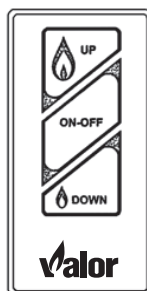

Adjusting Flame Height

Press and hold large flame  button to gradually increase flame height.

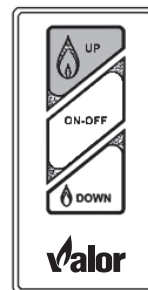

Press and hold small flame  button to gradually decrease flame height.

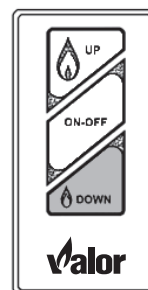
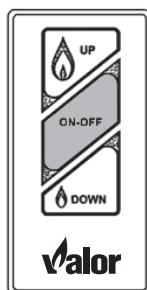

Notes